

Variable speed drives Altivar Process ATV900

Catalog

March 2019



Schneider
Electric

Quick access to product information

Get technical information about your product

References

Telefast Pre-wired System
Modicon ABE9 IP 67 passive splitter boxes

References						
Splitter boxes with connections by M2 connector						
Number of circuits	Connection by	LED indicator	Reference	Weight (kg)	Volume (cm ³)	Price (€)
4	A-1012	Yes	ABE9C1012	0.270	1.100	1.100
6	B-1012	Yes	ABE9C1012	0.280	1.100	1.100
8	C-1012	Yes	ABE9C1012	0.290	1.100	1.100
10	D-1012	Yes	ABE9C1012	0.300	1.100	1.100
Splitter boxes with connections by Cable						
Number of circuits	Connection by	LED indicator	Reference	Weight (kg)	Volume (cm ³)	Price (€)
4	A-1012	Yes	ABE9C1012	0.270	1.100	1.100
6	B-1012	Yes	ABE9C1012	0.280	1.100	1.100
8	C-1012	Yes	ABE9C1012	0.290	1.100	1.100
10	D-1012	Yes	ABE9C1012	0.300	1.100	1.100

Each commercial reference presented in a catalog contains a hyperlink. Click on it to obtain the technical information of the product:

- Characteristics, Dimensions and drawings, Mounting and clearance, Connections and schemas, Performance curves
- Product image, Instruction sheet, User guide, Product certifications, End of life manual

Schneider Electric

Add to favorites | Help | Historic

XB5AL73415
green flush/red projecting double-headed pushbutton Ø22 with marking

Download your XB5AL73415 datasheet

Change your selection

Discover other products & accessories

Discover your Schneider Electric tools

Characteristics | Dimensions Drawings | Mounting and Clearance | Documents & Downloads

Main

Range of product	Harmony XB5
Product or component type	Complete double-headed push-button
Device short name	XB5
Device material	Plastic
Fixing collar material	Plastic
Head type	Standard
Mounting diameter	22 mm
Shape of signaling unit head	Rectangular
Type of operator	Spring return
Operator profile	1 flush - 1 projecting push-buttons
Operator description	Green "I" - red "O"
Contacts type and composition	1 NO + 1 NC
Contact operation	Slow break

Find your catalog



- > With just 3 clicks, you can reach the Industrial Automation and Control catalogs, in both English and French
- > Download Digi-Cat with this [link](#)

General Catalog

Industrial Automation

360°

- Updated quarterly
- Embeds product selectors and configurators, 360° images, training centers,
- Optimized search by commercial reference

Select your training



- > Find the right [Training](#) for your needs on our Global website
- > Locate the training center with the selector tool, using this [link](#)

Training and courses

Training by domain of expertise

Local events
Webinars
E-learning courses

General contents

Presentation	1
Drive products	2
Drives for integration	3
Drive systems	4
Services, index	5

- **General presentation**..... page 1/2
- IP 20, IP 21, IP 54, or IP 55 variable speed drive selection guide* page 1/4
- Variable speed drives for cabinet integration selection guide* page 1/6
- IP 23 and IP 54 Drive Systems selection guide for asynchronous and synchronous motors* page 1/10
- **Altivar Process variable speed drives presentation** page 1/12



1

Altivar Process

Provides the efficiency you deserve

Altivar Process is the new comprehensive range of variable speed drives from Schneider Electric covering the majority of industrial applications with 2 series:

- > ATV600: drives focused on fluid management and processing and energy saving
- > ATV900: drives focused on maximum productivity with exceptional motor control and connectivity

Depending on customer requirements, Altivar Process drives are available as wall-mounting, floor standing and optimized solutions for integration into cabinets.



Altivar Process range

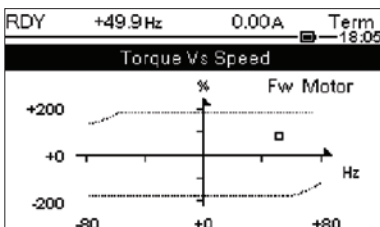

Torque Vs Speed display

Process efficiency

Motor performance and connectivity

- > Excellent motor performance on any type of motor
- > Ethernet dual port offers maximum services such as connection to the control room and process transparency
- > Network service helps ensure operation continuity even in case of connection breakdown
- > Web server and data logging help reduce downtime through fast troubleshooting and preventive maintenance

Complete control of your applications

- > Maximize your application performance by using Drive-to-Drive communication: total control of any kind of coupling in master/slave applications
- > Total management and flexibility of speed and torque on rigid and elastic coupling
- > Asset monitoring functions to increase production and reduce downtime

Real-time intelligence

Web server and services via Ethernet

- > Embedded web server interface based on the Ethernet network gives you process monitoring with your daily working tools.
- > Local and remote access to energy use and customized dashboards means your energy is visible anywhere, any time, on PC, tablet, or smartphone.



+ Motor control application performance

ODVA organization:
Supports network technologies based on EtherNet/IP

FDT Technology: An international standard with broad acceptance in the automation industry

User-friendliness

Simple integration in PLC environments

- > Easy integration thanks to standardized FDT/DTM and ODVA technology
- > Supported by predefined EcoStruxure Control Expert libraries
- > Easy access via PC, tablet, or smartphone
- > Robust connection via Ethernet



Achilles™ Level 2 certified



EcoStruxure™ Plant
Innovation At Every Level

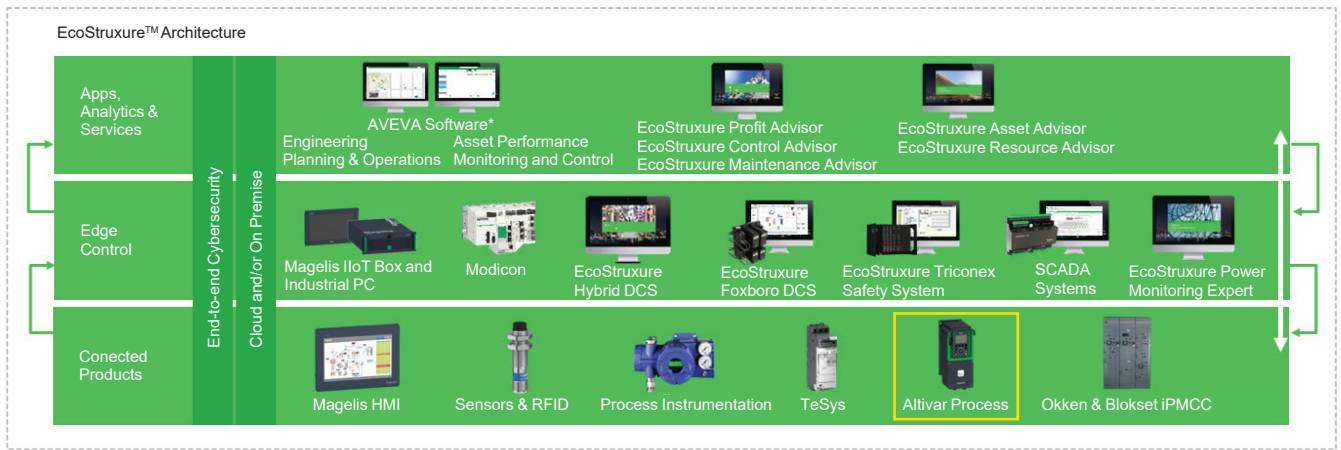

*Schneider Electric is a Strategic Technology Partner & Reseller of AVEVA



Scanning the QR code from a smartphone or tablet

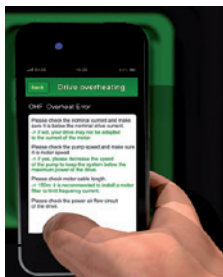

Instant access to online help

Sophisticated service concept

- > Modular design provides easy spare parts logistics
- > Optimized maintenance costs due to dynamic maintenance schedule, with integrated monitoring of individual components
- > Simple exchange of power modules and fans
- > Quick assistance with dynamic QR codes and Customer Care App

Green product

Designed to have a smaller carbon footprint

- > The Green Premium product label, Schneider Electric's eco-mark, indicates your compliance with international environmental standards such as:
 - > RoHS-2 according to EU directive C€ 2002/95
 - > REACH according to EU regulation 1907/2006
 - > IEC 62635: The end-of-life instructions comply with the latest recycling rules, 70% of the product components can be recycled.

IP 20, IP 21, IP 54, or IP 55 variable speed drives for asynchronous and synchronous motors

Market segments

- Oil & gas
- Mining, minerals & metals
- Food & beverage
- Water & wastewater



Mounting type	Wall-mounting
Degree of protection	IP 20 and IP 21/UL Type 1 IP 21/UL Type 1 without braking unit IP 55
Power range for 50...60 Hz line supply (1)	Three-phase: 200...240 V (kW/HP)
	Three-phase: 380...440 V (kW)
	Three-phase: 380...480 V (kW/HP)
	Three-phase 500...690 V (kW/HP)
Drive	Output frequency
	Control type
Functions	Advanced functions
	Integrated safety function
Number of integrated I/O	Analog inputs
	Digital inputs
	Digital output
	Analog outputs
	Relay outputs
	Safety function inputs
I/O extension modules (optional)	Analog inputs
	Digital inputs
Relay output module (optional)	Relay outputs
	Relay outputs
Communication	Integrated
	Option modules
Configuration and runtime tools	Graphic display terminal, embedded web server, DTM (Device Type Manager), SoMove software
Standards and certifications	UL 508C and UL61800-5-1 (2), EN/IEC 61800-3, EN/IEC 61800-3 environment 1 category C2, EN/IEC 61800-3 environment 2 category C3, EN/IEC 61800-5-1, IEC 61000-3-12, IEC 60721-3, IEC 61508, IEC 13849-1, REACH, SEMI F47-0706

References	ATW930●●●●● ATW930●●●●●C ATW950●●●●●
Page	2/2 2/8

(1) In "Normal duty" power values are given for applications requiring a slight overload (up to 120%). For power values in "Heavy duty" applications requiring a significant overload (up to 150%), see page 2/2.

- Oil & gas
- Mining, minerals & metals
- Food & beverage
- Water & wastewater



Mounting type	Wall-mounting	Floor-standing	
Degree of protection	IP 55 with Vario disconnect switch	IP 21 without braking unit	IP 54 with disconnect switch and without braking unit
Power range for 50...60 Hz line supply (1)	Three-phase: 200...240 V (kW/HP)	Three-phase: 380...440 V (kW)	Three-phase: 380...480 V (kW/HP)
	Three-phase: 380...440 V (kW)	Three-phase: 380...480 V (kW/HP)	Three-phase 500...690 V (kW/HP)
	Three-phase: 380...480 V (kW/HP)	Three-phase 500...690 V (kW/HP)	Three-phase 500...690 V (kW/HP)
	Three-phase 500...690 V (kW/HP)	Three-phase 500...690 V (kW/HP)	Three-phase 500...690 V (kW/HP)
Drive	Output frequency	Control type	Control type
	Control type	Asynchronous motor	Synchronous motor
Functions	Advanced functions	Integrated safety function	Number of preset speeds
	Number of preset speeds	Number of preset speeds	Number of preset speeds
Number of integrated I/O	Analog inputs	Digital inputs	Digital output
	Digital inputs	Digital output	Analog outputs
	Digital output	Analog outputs	Relay outputs
	Analog outputs	Relay outputs	Safety function inputs
	Relay outputs	Safety function inputs	Safety function inputs
	Safety function inputs	Safety function inputs	Safety function inputs
I/O extension modules (optional)	Analog inputs	Digital inputs	Digital outputs
	Digital inputs	Digital outputs	Digital outputs
Relay output module (optional)	Relay outputs	Relay outputs	Relay outputs
	Relay outputs	Relay outputs	Relay outputs
Communication	Integrated	Option modules	Option modules
	Option modules	Option modules	Option modules
Configuration and runtime tools	Graphic display terminal, embedded web server, DTM (Device Type Manager), SoMove software	Graphic display terminal, embedded web server, DTM (Device Type Manager), SoMove software	Graphic display terminal, embedded web server, DTM (Device Type Manager), SoMove software
Standards and certifications	UL 508C and UL61800-5-1 (2), EN/IEC 61800-3, EN/IEC 61800-3 environment 1 category C2, EN/IEC 61800-3 environment 2 category C3, EN/IEC 61800-5-1, IEC 61000-3-12, IEC 60721-3, IEC 61508, IEC 13849-1, REACH, SEMI F47-0706	EN/IEC 61800-3, EN/IEC 61800-3 environment 2 category C3, EN/IEC 61800-5-1, IEC 60721-3, IEC 61508, IEC 13849-1, REACH, SEMI F47-0706	EN/IEC 61800-3, EN/IEC 61800-3 environment 2 category C3, EN/IEC 61800-5-1, IEC 60721-3, IEC 61508, IEC 13849-1, REACH, SEMI F47-0706

References	ATW950●●●●●E ATW930●●●●●F ATW950●●●●●F
Page	2/5 2/6 2/9

(2) Evaluated UL standards may differ as per drive reference numbers. Please refer to our website for more details.

Altivar Process Modular single drives for cabinet integration

Market segments

- Water & wastewater
- Oil & gas
- Mining, minerals & metals
- Food & beverage



Mounting type	Cabinet integration
Degree of protection	IP 20
Power range for 50...60 Hz line supply	Three-phase: 380...480 V (kW/HP)
	Three-phase: 400 V (kW)
	Three-phase: 440 V (kW)
	Three-phase: 480 V (HP)
Drive	Output frequency
	Control type
Functions	Asynchronous motor
	Synchronous motor
Number of integrated I/O	Analog inputs
	Digital inputs
I/O extension modules (optional)	Digital inputs
	Digital outputs
Relay output module (optional)	Relay outputs
	Safety function inputs
Communication	Integrated
	Option modules
Configuration and runtime tools	
Standards and certifications	
References	
Page	

0.75...90/1...120
0.1...599 Hz
Standard constant torque, variable standard torque, optimized torque mode
PM (Permanent Magnet) motor, Synchronous Reluctance Motor
Including all the advanced features of ATV900:
■ Performance on motor control with an overload torque up to 180% Tn in an open or closed loop
■ Asynchronous, synchronous, special motors: all efficiency classes, brand independent, permanent magnet motors, torque motors, conical sliding rotor, reluctance motor
■ Integrated EtherNet/IP and Modbus TCP dual port, cybersecurity (Achilles Level 2)
■ Smart integration in PlantStruxure and Foxboro Evo process automation systems
■ Optimized energy efficiency, detection of energy consumption drift of the installation
■ Adaptation to the process by dedicated functions with modular design
■ Embedded safety functions STO SIL3
■ Master/slave and load sharing with drive-to-drive capability:
□ torque sharing on rigid coupling
□ torque sharing on elastic coupling
■ Contextual access to technical documentation through dynamic QR code
■ Continuous and historical real-time measurements with customizable dashboards
■ Predictive maintenance (e.g.: temperatures with PT100/1000 probe, fan monitoring, etc.)
Easy setting of drive identification from 110 kW up to 800 kW (150...1100 HP)
1: STO (Safe Torque Off) SIL3
16
3: 2 configurable as voltage (0...10 V) or current (0-20 mA/4-20 mA), including probes (PTC, PT100, PT1000, or KTY84) and 1 configurable as (0...±10 V)
8: Voltage 24 V $\overline{---}$ (positive or negative logic)
1: Assignable can be used as PTO (Pulse Train Output)
2: Configurable as voltage (0...10 V) or current (0-20 mA)
3: 1 with NO/NC contacts and 2 with NO contacts
2: For safety function STO
2 differential analog inputs configurable via software as current (0-20 mA/ 4-20 mA), or for PTC, PT100 or PT1000, 2 or 3-wire
6: Voltage 24 V $\overline{---}$ (positive or negative logic)
2: Assignable
3: NO contacts
EtherNet/IP, Modbus/TCP Dual port, Modbus serial link
CANopen Daisy chain, SUB-D and screw terminal block, PROFINET, PROFIBUS DP V1, DeviceNet, EtherCAT and POWERLINK
Graphic display terminal, embedded Web server, DTM (Device Type Manager), SoMove software
86/188/IEC, IEC 61000-4-2, IEC 61000-4-3, IEC 61000-4-4, IEC 61000-4-5, IEC 61000-4-6, EN/IEC 61800-3, EN/IEC 61800-5-1, IEC 61000-3-12, IEC 60721-3, IEC 61508, IEC 13849-1, TÜV certification, CE marking
ATV930●●●N4Z
3/6

- Water & wastewater
- Oil & gas
- Mining, minerals & metals
- Food & beverage



110...800	–	–
–	110...800	–
–	–	150...1100
0.1...599 Hz		
Standard constant torque, variable standard torque, optimized torque mode		
PM (Permanent Magnet) motor, Synchronous Reluctance Motor		
Including all the advanced features of ATV900:		
■ Performance on motor control with an overload torque up to 180% Tn in an open or closed loop		
■ Asynchronous, synchronous, special motors: all efficiency classes, brand independent, permanent magnet motors, torque motors, conical sliding rotor, reluctance motor		
■ Integrated EtherNet/IP and Modbus TCP dual port, cybersecurity (Achilles Level 2)		
■ Smart integration in PlantStruxure and Foxboro Evo process automation systems		
■ Optimized energy efficiency, detection of energy consumption drift of the installation		
■ Adaptation to the process by dedicated functions with modular design		
■ Embedded safety functions STO SIL3		
■ Master/slave and load sharing with drive-to-drive capability:		
□ torque sharing on rigid coupling		
□ torque sharing on elastic coupling		
■ Contextual access to technical documentation through dynamic QR code		
■ Continuous and historical real-time measurements with customizable dashboards		
■ Predictive maintenance (e.g.: temperatures with PT100/1000 probe, fan monitoring, etc.)		
Easy setting of drive identification from 110 kW up to 800 kW (150...1100 HP)		
1: STO (Safe Torque Off) SIL3		
16		
3: 2 configurable as voltage (0...10 V) or current (0-20 mA/4-20 mA), including probes (PTC, PT100, PT1000, or KTY84) and 1 configurable as (0...±10 V)		
8: Voltage 24 V $\overline{---}$ (positive or negative logic)		
1: Assignable can be used as PTO (Pulse Train Output)		
2: Configurable as voltage (0...10 V) or current (0-20 mA)		
3: 1 with NO/NC contacts and 2 with NO contacts		
2: For safety function STO		
2 differential analog inputs configurable via software as current (0-20 mA/ 4-20 mA), or for PTC, PT100 or PT1000, 2 or 3-wire		
6: Voltage 24 V $\overline{---}$ (positive or negative logic)		
2: Assignable		
3: NO contacts		
EtherNet/IP, Modbus/TCP Dual port, Modbus serial link		
CANopen Daisy chain, SUB-D and screw terminal block, PROFINET, PROFIBUS DP V1, DeviceNet, EtherCAT and POWERLINK		
Graphic display terminal, embedded Web server, DTM (Device Type Manager), SoMove software		
86/188/IEC, IEC 61000-4-2, IEC 61000-4-3, IEC 61000-4-4, IEC 61000-4-5, IEC 61000-4-6, EN/IEC 61800-3, EN/IEC 61800-5-1, IEC 61000-3-12, IEC 60721-3, IEC 61508, IEC 13849-1, TÜV certification, CE marking		
ATV9A0C●●Q4	ATV9A0C●●R4	ATV9A0C●●T4
3/8	3/9	3/10

Altivar Process Modular single drives for cabinet integration

Market segments

- Water & wastewater
- Oil & gas
- Mining, minerals & metals
- Food & beverage



Mounting type	Cabinet integration
Degree of protection	IP00
Power range for 50...60 Hz line supply	Three-phase: 500 V (kW)
	Three-phase: 600 V (HP)
	Three-phase: 690 V (kW)
Drive	Output frequency
	Control type
Functions	Asynchronous motor
	Synchronous motor
Number of integrated I/O	Analog inputs
	Digital inputs
I/O extension modules (optional)	Digital outputs
	Relay outputs
Relay output module (optional)	Relay outputs
	Safety function inputs
Communication	Embedded
	Option modules
Configuration and runtime tools	Graphic display terminal, embedded Web server, DTM (Device Type Manager), SoMove software
Standards and certifications	86/188/EEC, IEC 61000-4-2, IEC 61000-4-3, IEC 61000-4-4, IEC 61000-4-5, IEC 61000-4-6, EN/IEC 61800-3, EN/IEC 61800-5-1, IEC 61000-3-12, IEC 60721-3, IEC 61508, IEC 13849-1, TÜV certification, CE marking, cUL
References	ATV9A0...N6 ATV9A0...T6 ATV9A0...Q6
Page	3/11 3/12 3/13

- Water & wastewater
- Oil & gas
- Mining, minerals & metals
- Food & beverage



Mounting type	Cabinet integration
Degree of protection	IP00
Power range for 50...60 Hz line supply	75...800
	–
	–
Drive	Output frequency
	Control type
Functions	Asynchronous motor
	Synchronous motor
Number of integrated I/O	Analog inputs
	Digital inputs
I/O extension modules (optional)	Digital outputs
	Relay outputs
Relay output module (optional)	Relay outputs
	Safety function inputs
Communication	Embedded
	Option modules
Configuration and runtime tools	Graphic display terminal, embedded Web server, DTM (Device Type Manager), SoMove software
Standards and certifications	86/188/EEC, IEC 61000-4-2, IEC 61000-4-3, IEC 61000-4-4, IEC 61000-4-5, IEC 61000-4-6, EN/IEC 61800-3, EN/IEC 61800-5-1, IEC 61000-3-12, IEC 60721-3, IEC 61508, IEC 13849-1, TÜV certification, CE marking, cUL
References	ATV9B0...N6 ATV9B0...T6 ATV9B0...Q6
Page	3/14 3/15 3/15

IP 23 and IP 54 Drive Systems for asynchronous and synchronous motors

1

Market segments

- Oil & gas
- Mining, minerals & metals
- Food & beverage
- Water & wastewater



Power range for 50...60 Hz line supply Three-phase: 315...415 V, 480 V (kW)

90...800

Main characteristics

High Performance Drive Systems with an integrated line reactor to reduce the current harmonics
THDi < 48%

Variants

High Performance standard offer
Modular with integrated options (CTO)
User-definable on request (ETO, full ETO)

Degree of protection

IP 23
IP 54 with separate air flows as an option

Drive
Output frequency
Control type Asynchronous motor
Synchronous motor

0.1...599 Hz
Standard constant torque, variable standard torque, optimized torque mode
PM (Permanent Magnet) motor, Synchronous Reluctance Motor

Communication
Integrated
Option modules

EtherNet/IP and Modbus/TCP dual port, Modbus serial link
PROFINET, CANopen RJ45 Daisy Chain, Sub-D and screw terminals, Profibus DP V1, EtherCAT and DeviceNet

Interfaces and runtime tools

Graphic display terminal in the enclosure door
Control terminals inside the enclosure
Control terminals can be extended
Reading of the parameters via USB interface on the keypad
Embedded Web server, DTM (Device Type Manager), SoMove software

Standards and certifications

CE, EAC, RCM, EN/IEC 61439, EN/IEC 61800-3, EN/IEC 61800-3 environment 2 category C3, EN/IEC 61800-5-1, IEC 60721-3, IEC 61508, ATEX 2/22, ATEX 1/21

References

ATV960●●●●4X1

Page

4/4

1

- Oil & gas
- Mining, minerals & metals
- Food & beverage
- Water & wastewater



90...800

Regenerative Drive Systems with 3-level active mains rectifier for an efficient flow of energy to and from the mains.

Regenerative standard offer
Modular with integrated options (CTO)
User-definable on request (ETO, full ETO)

IP 23
IP 54 with separate air flows as an option

0.1...599 Hz
Standard constant torque, variable standard torque, optimized torque mode
PM (Permanent Magnet) motor, Synchronous Reluctance Motor

EtherNet/IP and Modbus/TCP dual port, Modbus serial link
PROFINET, CANopen RJ45 Daisy Chain, Sub-D and screw terminals, Profibus DP V1, EtherCAT and DeviceNet

Graphic display terminal in the enclosure door
Control terminals inside the enclosure
Control terminals can be extended
Reading of the parameters via USB interface on the keypad
Embedded Web server, DTM (Device Type Manager), SoMove software

CE, EAC, RCM, EN/IEC 61439, EN/IEC 61800-3, EN/IEC 61800-3 environment 2 category C3, EN/IEC 61800-5-1, IEC 60721-3, IEC 61508, ATEX 2/22, ATEX 1/21, IEEE 519

ATV980●●●●4X1

4/10

1



Altivar Process range

Process automation

Altivar Process drives are specifically designed for meeting the requirements of following market segments:

- Oil & gas
- Mining, minerals & metals
- Food & beverage
- Water & wastewater

The Altivar Process 900 series is focused on maximum productivity with exceptional motor control and connectivity.

It offers special functionalities for the industrial process segments:

- Excellent motor performance on any type of motor
- Total control of any kind of coupling in master/slave applications
- Network services help ensure operation continuity even in case of connection breakdown
- Web server and data logging help reduce downtime through fast troubleshooting and preventive maintenance

EcoStruxure Foxboro DCS process automation system

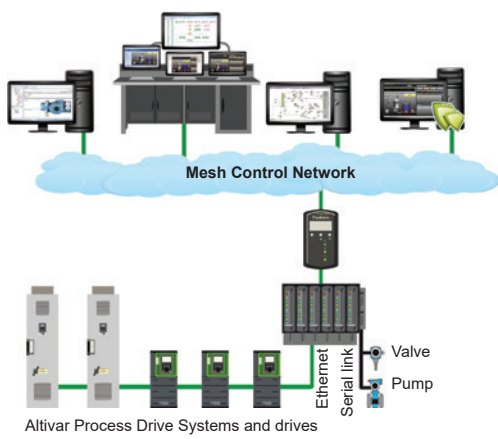

Altivar Process in EcoStruxure Foxboro DCS architecture

EcoStruxure Plant™ integration

The association of Altivar Process services with Schneider Electric process automation control systems like EcoStructure Foxboro DCS (for process systems) or EcoStruxure Hybrid DCS (for hybrid systems) offers a high-performance, global automation and motor control solution with optimized total cost of ownership (TCO).

The solution provides operational integrity for people, processes, and assets, with improved maintenance support to reduce downtime and helps to ensure operation continuity.

It offers operational insight by accessing more information to optimize the process and control the energy efficiency.

Based on market standards (FDT/DTM, Ethernet, etc.), it is a sustainable, scalable solution that enables processes to be adapted easily and affordably.



Oil & gas applications

- Hydrocarbon production:
 - Drilling
 - Offshore and onshore extraction
 - Water treatment and re-injection
 - Crude oil storage
 - Separation
 - Pipeline pumping
 - Storage
 - Refining
 - DOF (Digital Oil Field)

Use

- PCP (Progressive Cavity Pump)
- ESP (Electrically Submersible Pump)
- Rod pump
- Mud pump
- Rotary table, top drive
- Draw works
- Regasification compressor





Process automation (continued)

Mining, minerals & metals applications

- Open-pit or underground mining
- Stockpiling/homogenization
- Concentration/mineral separation
- Solid-liquid separation
- Final handling/transport
- Clinker production
- Cement production

Use

- Long distance heavy conveying
- Bucket wheel excavator
- Special cranes:
 - Gantry cranes
 - Grab cranes
- Crushing
- Grinding mills (ball mills, SAG and AG mills)
- Spiral and magnetic separators
- Reclaimers and stackers
- Ship loaders
- Mobile miner
- Vibro feeders
- Crusher
- Long belt conveyor
- Kiln main drive
- Separator for VRM (Vertical Roller Mill)



Food & beverage applications

- Dairy beverage
- Agribusiness

Use

- Conveyors
- Mixers
- Shredders
- Centrifuges
- Hot rotary dryers



Water & wastewater applications

- Treatment plant
- Wastewater treatment

Use

- Decanter

1



Cooling system with two separate air flows

General presentation of the offer

Altivar Process drives can help improve equipment performance and reduce operating costs by optimizing energy consumption and user comfort.

Altivar Process drives provide a wide range of integrated functions, such as:

- Safety and automation functions that meet the requirements of the most demanding applications
- Various optional fieldbus modules available for seamless integration into the main automation architectures
- Numerous configurable I/O as standard to facilitate adaptation to specific applications
- Intuitive commissioning using the graphic display terminal
- Local and remote access and monitoring using the embedded Web server
- Energy savings and protection of the grid by means of integrated harmonic filters
- Installation EMC conformity by means of integrated EMC filters

Depending on the power range, Altivar Process is available with several mounting types and protection indices:

- Wall-mounting IP 20 and 21/UL Type 1 from 0.75 kW/1 HP to 315 kW/500 HP, ready-to-use for easy integration inside or without an enclosure in an electrical room
- Wall-mounting IP 55 from 0.75 kW/1 HP to 90 kW/125 HP, ready-to-use for easy integration in harsh environment and installations close to the system to reduce the length of the motor cable (the wall-mounting IP 55 offer is available with and without a disconnect switch)
- Floor-standing IP 21 and IP 54 from 110 to 315 kW, ready-to-use with minimum dimensions for easy, optimized integration in an electrical room in a standard or harsh environment
- Cabinet integration from 75 to 1200 kW/125 to 1200 HP, designed for easy and cost effective integration of power intensive drives into cabinets.
- Cabinet integration IP 20 from 0.75 to 90 kW/1 to 125 HP, for easy and cost effective drive configuration inside enclosures.

Cabinet integration

Get more than just a drive with Altivar Process Modular offer for cabinet integration:

- Standardized and cost efficient integration with power rating through module paralleling up to 1200 kW/1200 HP at 690 V
- Integrated category C3 EMC filter
- Reduced harmonics with integrated line choke for standard single drives and less than 3% THDi for Low Harmonic (LH)/Regenerative single drives
- Integrated high efficient motor filter reducing the risk of motor winding insulation aging and motor damage even for longer motor cables
- Ready-to-connect mains terminals on top and motor terminals at the bottom
- Reduced downtime of assets thanks to easily changeable electric core components such as power module with wheel (for standard single drives) and power fan (for LH/Regen and standard single drives) inside a drawer accessible from front face

Enclosed drives solutions

The floor-standing IP 21/IP 54 fully customisable turnkey drive offers integrate:

- Drive power and control modules
- Semiconductor protection fuses
- Line chokes to limit THDi levels
- A filter to help protect the motor against the effects of dv/dt
- Accessible busbars to simplify the motor wiring and power wiring

The IP 54 variant is fitted with additional equipment, such as:

- A main switch with external handle
- A system for separating the cooling air flow between the power and control parts, allowing operation in a very polluted environment as well as optimum management of thermal stress in the plant room

Altivar Process drives can be supplied as Engineered Drive System variants from 75 to 1200 kW/125 to 1200 HP, developed by Schneider Electric based on customer specifications. Engineered drives are available as standard with THDi level < 48% and as a Low Harmonic/Regen solution with THDi level < 3%.



ATV930D45Y6 equipped with IP20/UL Type 1 wall mounting kit

General presentation of the offer (continued)

Rugged

Altivar Process drives are designed to adapt to the harshest environments.

- Ambient operating temperature
- Wall-mounting drives:
 - IP 20 and 21: up to 160 kW, -15...+50 °C/+5...122 °F as standard, up to 60 °C/140 °F with derating; above 160 kW, -10...+40 °C/+14...104 °F as standard, up to 60 °C/140 °F with derating
 - IP 55: -15...+40 °C/5...104 °F as standard, up to 50 °C/122 °F with derating
- Floor-standing IP 21/IP 54 and cabinet integration drives:
 - 0...40 °C/32...104 °F as standard
 - 40...50 °C/104...122 °F with derating
- Relative humidity without condensing: 5...95%
- Storage and transport temperature: -40...+70 °C/-40...+158 °F
- Operating altitude:
 - 0...1,000 m/0...3,281 ft without derating
 - 1,000...4,800 m/3,281...15,700 ft with derating of 1% per 100 m/328 ft (1)
- Withstand to harsh environments:
 - Chemical class 3C3 conforming to IEC/EN 60721-3-3 (1)
 - Mechanical class 3S3 conforming to IEC/EN 60721-3-3 (1)
 - Printed circuit boards with protective coating
- Protection to suit requirements:
 - IP 00 for mounting in an enclosure, depending on the model
 - IP 20 and 21/UL Type 1 for wall mounting in a plant room and in an enclosure
 - IP 55 for wall mounting, with protection against dust and water jets
 - Floor-standing IP 21
 - Floor-standing IP 54, with protection against dust and water jets

A large number of external options can be combined with the Altivar 900:

- Braking units and resistors
- Line chokes and passive filters (see [page 2/48](#))
- Additional EMC input filters for reducing conducted emissions on the line (see [pages 2/46 and 2/47](#))
- Dv/dt and sinus filters for long cable runs or to remove the need for shielding (see [pages 2/49 to 2/51](#))
- Mounting options: The Altivar 900 drive can be mounted in a variety of ways to adapt to the various needs of an installation.
 - Mounting without an enclosure: The Altivar 900 drive can be mounted directly on a wall without having to be installed inside an enclosure. IP 20 and 21/UL Type 1 conformity can be achieved by using kits, for drives above 110 kW at 380...480 V and for drives from 2.2 to 90 kW at 500...690 V a supply voltage (see [page 2/10](#))
 - Optimized enclosures: A patented flange mounting kit allows to remove the heat generated by the power unit outside the enclosure when the variable speed drive is integrated in a cabinet (see [page 2/11](#))

Energy

Altivar Process drives help to optimize power consumption by reducing the rms input current for the same load.

- Standard offer:
 - THDi ≤ 48% for 80 to 100% load, which is used to maintain an optimum power factor on the most common operating range
 - Embedded low harmonic DC choke technology complying with standard IEC 61000-3-12 for 380...480 V offer
 - Embedded line choke for cabinet integration and floor standing drives solutions
- Passive filter options
 - Low harmonic offer compatible with standard IEEE 519

Environment

The Altivar Process drive has been developed to meet the requirements of directives regarding protection of the environment and anticipate future changes in regulations:

- RoHS-2 (2)
- REACH (3) + Solution for REACH Substitute It Now (halogen-free wiring and plastics)
- PEP (Product Environmental Profile) eco-passport Program for reducing the carbon footprint and conserving raw materials
- EoL (End of Life Instruction) (4)
- More than 70% recyclable materials (new ruling)
- Efficient energy management: 30% reduction in consumption

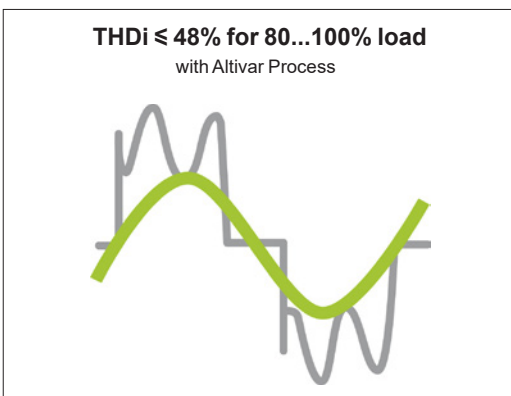

Altivar Process drive THDi

(1) Altivar Process ATV930C22...C31N4 drives are certified as chemical class 3C2 and mechanical class 3S2 conforming to IEC/EN 60721.

(2) European directive 2002/95/EC Restriction Of Hazardous Substances (applicable in 2016)

(3) European regulation 1907/2006

(4) According to IEC 62635 Enhanced Guidelines

General presentation of the offer (continued)

Electromagnetic compatibility (EMC)

Compliance with electromagnetic compatibility requirements has been incorporated into the design of the Altivar Process Modular drives, which simplifies installation and provides an economical means of helping to ensure equipment meets CE marking requirements.

Altivar Process drives have a category C2 or C3 EMC filter, except ATV930●●●M3 and ATV930●●●M3C models that can be equipped with an additional filter to meet more stringent requirements (see [page 2/41](#)).

Altivar Process Modular drives have category C3 EMC filters that allow 300 m/980 ft of shielded motor cables.

Installation/Maintenance

Altivar Process drives are ergonomically designed to adapt to any type of installation:

- Products, systems, or integrated in iMCC
- IP 00 modules that can be integrated in cabinets with an IP 21 (UL Type 1) or IP 54 (UL Type 12) protection degree as a standard integration
- IP 20 and 21/UL Type 1; IP 55, IP 54
- Easy installation of products and systems:
 - Cable entry equipped with Romex cable clamps to maintain an EMC connection for the power and control cable (optional for 500...690 V drives)
 - Color code for connections to the removable terminal blocks on the HMI block
 - Long cable for wall mounting : Up to 150 m with category C3 EMC filter at 380...480V
 - Long cable for Altivar Process Modular and Floor Standing offer: highly efficient integrated motor filters for dv/dt and common mode reduction and voltage peak limitation allows motor cable lengths up to 300 m/980 ft with shielded cable (category C3 environment) and 500 m/1640 ft with unshielded cable (category C4 environment).
- Asynchronous or synchronous motor in open loop or closed loop for 0.1...599 Hz output frequency
- Special motors: Conical sliding rotor, reluctance motor
- Lower maintenance costs due to drive's ergonomic design:
 - Fans can be replaced in less than 5 minutes
 - No maintenance tool required
 - Limited number of parts
- Embedded Web server:
 - Compatible process elements for easier implementation
 - Direct worldwide access to monitoring and maintenance functions:
 - Reading values
 - Modifying data
 - Configuring parameters
 - Changing controller status

Integrated functions

Altivar Process drives include numerous advanced functions for the more complex applications in each market segment.

Advanced functions

- Performance on motor control with an overload torque up to 180% Tn in an open or closed loop
- Asynchronous, synchronous, special motors: all efficiency classes, brand independent, permanent magnet motors, torque motors, conical sliding rotor, reluctance
- Integrated EtherNet/IP and Modbus TCP dual port, cybersecurity (Achilles Level 2)
- Smart integration in PlantStruxure and Foxboro Evo process automation systems
- Optimized energy efficiency, detection of energy consumption drift of the installation
- Adaptation to the process by dedicated functions with modular design
- Embedded safety functions STO SIL3
- Master/slave and load sharing with drive-to-drive capability:
 - torque sharing on rigid coupling
 - torque sharing on elastic coupling
- Contextual access to technical documentation through dynamic QR code
- Continuous and historical real-time measurements with customizable dashboards
- Predictive maintenance (e.g.: temperatures with PT100/1000 probe, fan monitoring, etc.)

Integrated functions (continued)

Power measurement function

Altivar Process drives integrate a power measurement function accurate to within 5%, based on measurement of the motor voltage and the power supply:

- Process drift detection for installation reliability throughout its entire service life
- Useful system performance information provided by comparing the energy used with the energy produced:

- Typical KPIs:
 - Specific energy consumption

Users are therefore able to monitor and analyze input power, energy produced, and the KPIs directly from the drive or from the process management system.

Safety and monitoring functions

The Safety function STO and numerous monitoring functions are provided to help protect people and equipment.

- Advantages:
 - Time savings in terms of installation design and compliance
 - Fewer components and cables
 - Optimum space
 - Simplified setup of machines
 - Improved maintenance performance; limited machine intervention time and installation downtime
 - Optimized conditions for maintenance operations
- Conformity to standards EN/IEC 61508, EN/ISO 13849, IEC 61800-5-2
- Integrated STO (Safe Torque Off) function, SIL3/PlE
- Monitoring function to help protect against premature wear

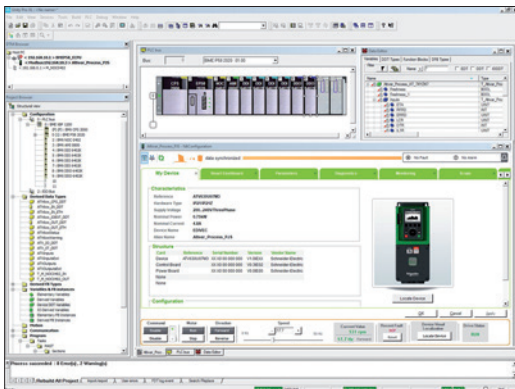

Altivar Process DTM in EcoStruxure Control Expert

Integration

Fieldbus protocols

- EtherNet/IP and Modbus/TCP Dual port and Modbus serial link:
 - Standard Modbus and Ethernet protocols
 - Connection of configuration and runtime tools
 - Control and supervision of the Altivar Process in process architectures (controllers, SCADA, HMIs, etc.) in industrial networks (read/write data)
 - Diagnostic, supervision, and fieldbus management functions
- Ethernet services:
 - SNMP, SNTP, BootP & DHCP, IP v6, cybersecurity services, FDR
 - Open Ethernet topologies

Integration of configuration and runtime tools

- FDT/DTM technology (see [page 2/17](#)):
 - Drive configuration, diagnostics, and control using EcoStruxure Control Expert or Foxboro Evo software

Configuration and runtime tools

- Graphic display terminal (see [page 2/14](#)):
 - Drive control, adjustment, and configuration
 - Display of current values (motor, I/O, etc.)
 - Configuration storage and download
 - Duplication of one drive configuration on another drive from a PC or another drive
 - Remote use by means of appropriate accessories (see [page 2/15](#))
 - Connection to several drives using multidrop link components (see [page 2/15](#))
- Embedded web server (see [page 2/16](#)):
 - Easily accessible from any PC, iPhone, iPad, Android system, and major web browsers
 - Network diagnostics in real time
 - Read/write values
- SoMove software (see [page 2/17](#)):
 - Advanced functions for configuration, setup, and maintenance of Altivar Process drives

Integrated services

Altivar Process drives feature integrated services to achieve optimum time savings:

- Simplified communication:
 - Ethernet dual port with embedded web server
 - Energy management (integrated power measurement)
 - Dynamic predictive maintenance
- 3 QR codes:
 - 1: Access to the [Customer Care Center](#) application and product data sheet
 - 2: Direct access to description of the functions
 - 3: QR code generated in the event of a detected error (red screen): Identification of the detected error, probable causes and remedies

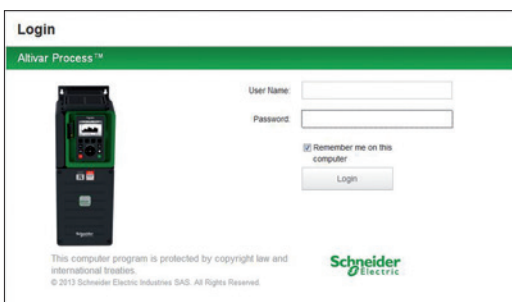

Embedded web server login screen

Altivar Process ATV900 variable speed drives

- Altivar Process variable speed drives presentation [page 2/2](#)
- 200...240 V 50/60 Hz supply, IP 21/UL Type 1 [page 2/4](#)
- 380...480 V 50/60 Hz supply, wall-mounting [page 2/5](#)
- IP 21/UL Type 1, with integrated category C2 or C3 EMC filter [page 2/5](#)
- IP 55, with integrated category C2 or C3 EMC filter [page 2/7](#)
- IP 55, with Vario disconnect switch and integrated category C2 or C3 EMC filter [page 2/8](#)
- 500...690 V 50/60 Hz supply, IP 00 [page 2/9](#)
- 380...440 V 50/60 Hz supply, floor-standing [page 2/10](#)
- IP 21, with integrated category C3 EMC filter [page 2/10](#)
- IP 54, with integrated category C3 EMC filter [page 2/11](#)
- Replacement parts [page 2/12](#)
- Accessories [page 2/13](#)
- Graphic display terminal [page 2/14](#)
- Accessories for graphic display terminal [page 2/15](#)
- Web server [page 2/16](#)
- DTM libraries and SoMove setup software [page 2/17](#)

Options

- Drive/option combinations [page 2/18](#)
- Encoder modules and I/O expansion modules [page 2/24](#)
- Communication buses and networks [page 2/26](#)
- Braking units and resistors [page 2/32](#)
- Passive filters [page 2/40](#)
- EMC filters [page 2/46](#)
- dv/dt filters [page 2/49](#)
- Sinus filters [page 2/52](#)
- Common mode filters [page 2/54](#)

Motor starters

- 200...240 V 50/60 Hz supply [page 2/56](#)
- 380...415 V 50/60 Hz supply [page 2/57](#)
- 440 V 50/60 Hz supply [page 2/59](#)
- 500...690 V 50/60 Hz supply [page 2/61](#)

Dimensions

- Drives [page 2/62](#)
- Options [page 2/68](#)

2



ATV930...N4F, ATV930...M3, ATV930...Y6, ATV950...N4, ATV950...N4E

Extensive offer

The Altivar Process wall mounting and floor standing products offer covers motor power ratings from 0.75...315 kW for three-phase voltages between 200...240 V, 380...480 V and 500...690 V.

Three-phase power supply	Motor power	Degree of protection	Reference
200...240 V (- 15...10%)	0.75 kW...75 kW 1...100 HP	IP 21 UL type 1	ATV930U07M3...D45M3 ATV930D30M3C...D75M3C
380...480 V (- 15...10%)	0.75 kW...315 kW 1...500 HP	IP 21 UL type 1 IP 21 UL type 1 IP 55	ATV930U07N4...C22N4 (1) ATV930D55N4C...C31N4C (2) ATV950U07N4...D90N4 ATV950U07N4E...D90N4E (3)
380...440 V (- 15...10%)	110 kW...315 kW	IP 21 IP 54	ATV930C11N4F...C31N4F ATV950C11N4F...C31N4F
500...690 V (- 15...10%)	2.2...90 kW 3...125 HP	IP 20 UL Type 1	ATV930U22Y6...D90Y6

(1) Also [ATV930U07N4Z...D22N4Z](#) (IP20 UL type 1)
 (2) Also [ATV930D55N4Z...D90N4Z](#) (IP00 UL type 1)
 (3) Integrated disconnect switch

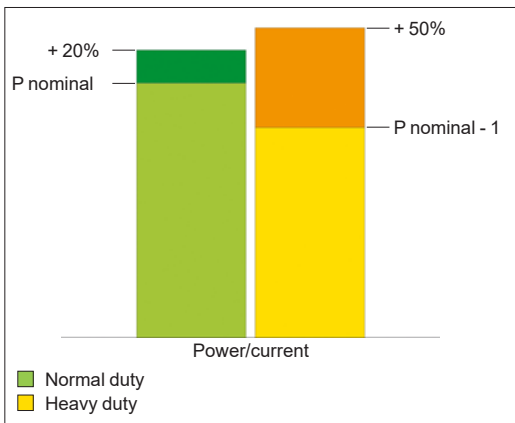

Normal duty and Heavy duty modes

Altivar Process variable speed drives are designed for use in two operating modes that can optimize the drive nominal rating according to the system constraints.

These two modes are:

- Normal duty (ND): Dedicated mode for applications requiring a slight overload (up to 120%) with a motor power no higher than the drive nominal power
- Heavy duty (HD): Dedicated mode for applications requiring a significant overload (up to 150%) with a motor power no higher than the drive nominal power derated by one rating

Accessories and options

Altivar Process drives are designed to take numerous accessories and options to increase their functionality and also their capacity for integration and adaptation.

Accessories

- Drive:
- Fan kit (see [page 2/10](#))
- Graphic display terminal:
- Remote mounting kit for mounting on enclosure door (see [page 2/15](#))
- Multidrop connection accessories for connecting several drives to the RJ45 terminal port (see [page 2/15](#))

Options

- Modules (see [page 2/25](#)):
- I/O extension:
 - 2 analog inputs
 - 6 digital inputs
 - 2 digital outputs
- With relay output:
 - 3 NO contacts
- Communication:
 - CANopen bus: RJ45 daisy chain, SUB-D, 5-way screw terminals
 - PROFINET bus
 - Profibus DP V1 bus
 - EtherCAT
 - DeviceNet bus
- Encoder modules (see [page 2/24](#)):
- Digital encoder interface module 5/12 V
- Analog encoder interface module
- Resolver interface module
- HTL encoder interface module
- Braking units and braking resistors (see [page 2/32](#))
- Passive filters (see [page 2/40](#))
- Additional EMC input filters for reducing conducted emissions on the line (see [page 2/46](#))
- Output filters:
 - dv/dt filters (see [page 2/49](#))
 - Sinus filters (see [page 2/52](#))
 - Common mode filters (see [page 2/54](#))

Motor starters

Schneider Electric offers combinations of circuit breakers and contactors to be able to use Altivar Process drives in optimum conditions (see [page 2/56](#)). For prospective line short circuit current up to 100 kA, please contact our [Customer Care Center](#).

Variable speed drives

Altivar Process ATV900

Three-phase supply voltage: 200...240 V 50/60 Hz



ATV930D11M3



ATV930D15M3



ATV930D30M3

200...240 V (-15...10%) IP 21/UL Type 1 drives - Wall mounting with braking unit										
Motor		Line supply				Altivar Process				
Power indicated on rating plate (1)		Line current (2)		Apparent power	Prospective line Isc	Maximum continuous current (1)	Maximum transient current for 60 s	Reference (3)	Weight	
		200 V	240 V							240 V
ND:	Normal duty (4)									
HD:	Heavy duty (5)									
	kW	HP	A	A	kVA	kA	A	A	kg/lb	
Without EMC filter (3)										
ND	0.75	1	3	2.6	1.1	50	4.6	5.5	ATV930U07M3	4.300/9.480
HD	0.37	0.5	1.7	1.5	0.6	50	3.3	5		
ND	1.5	2	5.9	5	2.1	50	8	9.6	ATV930U15M3	4.300/9.480
HD	0.75	1	3.3	3	1.2	50	4.6	6.9		
ND	2.2	3	8.4	7.2	3	50	11.2	13.4	ATV930U22M3	4.500/9.921
HD	1.5	2	6	5.3	2.2	50	8	12		
ND	3	–	11.5	9.9	4.1	50	13.7	16.4	ATV930U30M3	4.500/9.921
HD	2.2	3	8.7	7.6	3.2	50	11.2	16.8		
ND	4	5	15.1	12.9	5.4	50	18.7	22.4	ATV930U40M3	4.600/10.141
HD	3	–	11.7	10.2	4.2	50	13.7	20.6		
ND	5.5	7.5	20.2	17.1	7.1	50	25.4	30.5	ATV930U55M3	7.700/16.976
HD	4	5	15.1	13	5.4	50	18.7	28.1		
ND	7.5	10	27.1	22.6	9.4	50	32.7	39.2	ATV930U75M3	13.800/30.424
HD	5.5	7.5	20.1	16.9	7	50	25.4	38.1		
ND	11	15	39.3	32.9	13.7	50	46.8	56.2	ATV930D11M3	13.800/30.424
HD	7.5	10	27.2	23.1	9.6	50	32.7	49.1		
ND	15	20	52.6	45.5	18.9	50	63.4	76.1	ATV930D15M3	27.300/60.186
HD	11	15	40.1	34.3	14.3	50	46.8	70.2		
ND	18.5	25	66.7	54.5	22.7	50	78.4	94.1	ATV930D18M3	27.300/60.186
HD	15	20	53.1	44.9	18.7	50	63.4	95.1		
ND	22	30	76.0	64.3	26.7	50	92.6	111.1	ATV930D22M3	27.300/60.186
HD	18.5	25	64.8	54.5	22.7	50	78.4	117.6		
ND	30	40	104.7	88.6	36.8	50	123	147.6	ATV930D30M3	57.600/126.986
HD	22	30	78.3	67.1	27.9	50	92.6	138.9		
ND	37	50	128.0	107.8	44.8	50	149	178.8	ATV930D37M3	57.600/126.986
HD	30	40	104.7	88.6	36.8	50	123	184.5		
ND	45	60	155.1	130.4	54.2	50	176	211.2	ATV930D45M3	57.600/126.986
HD	37	50	128.5	108.5	45.1	50	149	223.5		

200...240 V (-15...10%) IP 21/UL Type 1 drives - Wall mounting without braking unit										
Motor		Line supply				Altivar Process				
Power indicated on rating plate (1)		Line current (2)		Apparent power	Prospective line Isc	Maximum continuous current (1)	Maximum transient current for 60 s	Reference (3)	Weight	
		200 V	240 V							240 V
ND:	Normal duty (4)									
HD:	Heavy duty (5)									
	kW	HP	A	A	kVA	kA	A	A	kg/lb	
Without EMC filter (3)										
ND	30	40	104.7	88.6	36.8	50	123	147.6	ATV930D30M3C	56.600/124.782
HD	22	30	78.3	67.1	27.9	50	92.6	138.9		
ND	37	50	128.0	107.6	44.8	50	149	178.8	ATV930D37M3C	56.600/124.782
HD	30	40	104.7	88.6	36.8	50	123	184.5		
ND	45	60	155.1	130.4	54.2	50	175	211.2	ATV930D45M3C	56.600/124.782
HD	37	50	128.5	108.5	45.1	50	149	223.5		
ND	55	75	189	161	61.1	50	211	253.2	ATV930D55M3C	82.000/180.779
HD	45	60	156	134	50	50	176	264	(6)	
ND	75	100	256	215	83.7	50	282	338.4	ATV930D75M3C	82.000/180.779
HD	55	75	189	161	61.1	50	211	316.5	(6)	

- (1) These values are given for a nominal switching frequency of 4 kHz up to **ATV930D22M3** or 2.5 kHz for **ATV930D30M3...D45M3** and **ATV930D30M3C...D75M3C**, for use in continuous operation. The switching frequency is adjustable. Above 2.5 or 4 kHz (depending on the rating), the drive will automatically reduce the switching frequency in the event of an excessive temperature rise. For continuous operation above the nominal switching frequency, derate the nominal drive current (see derating curves on our website www.schneider-electric.com).
- (2) Typical value for the indicated motor power and for the prospective line Isc.
- (3) Altivar Process **ATV930...M3** drives have been designed without an EMC filter. An additional filter can be added to help meet more stringent requirements and reduce electromagnetic emissions.
- (4) Values given for applications requiring a slight overload (up to 120%).
- (5) Values given for applications requiring a significant overload (up to 150%).
- (6) The power parts are accessible at the bottom of the drive. Product supplied as IP 00 for mounting in an enclosure. For IP 21 wall mounting, order the IP 21/UL Type 1 conformity kit **VW3A9704** separately (see page 2/11).

Note: Consult the summary tables of possible drive, option, and accessory combinations (see page 2/18).

Variable speed drives

Altivar Process ATV900

Three-phase supply voltage: 380...480 V 50/60 Hz



ATV930D15N4



ATV930D30N4



ATV930D55N4

380...480 V (-15...10%) IP 21/UL Type 1 drives - Wall mounting with braking unit										
Motor	Line supply					Altivar Process				
	Power indicated on rating plate (1)		Line current (2)		Apparent power	Prospective line Isc	Maximum continuous current (1)	Maximum transient current for 60 s	Reference (3)	Weight
ND:	HP	380 V	480 V	380 V	A					
HD:	HP									
With category C2 or C3 integrated EMC filter (6)										
ND	0.75	1	1.5	1.3	1.1	50	2.2	2.6	ATV930U07N4	4.500/9.921
HD	0.37	0.5	0.9	0.8	0.7	50	1.5	2.3		
ND	1.5	2	3	2.6	2.2	50	4	4.8	ATV930U15N4	4.500/9.921
HD	0.75	1	1.7	1.5	1.2	50	2.2	3.3		
ND	2.2	3	4.3	3.8	3.2	50	5.6	6.7	ATV930U22N4	4.500/9.921
HD	1.5	2	3.1	2.9	2.4	50	4	6		
ND	3	-	5.8	5.1	4.2	50	7.2	8.6	ATV930U30N4	4.600/10.362
HD	2.2	3	4.5	4	3.3	50	5.6	8.4		
ND	4	5	7.6	6.7	5.6	50	9.3	11.2	ATV930U40N4	4.600/10.141
HD	3	-	6	5.4	4.5	50	7.2	10.8		
ND	5.5	7.5	10.4	9.1	7.6	50	12.7	15.2	ATV930U55N4	4.700/10.362
HD	4	5	8	7.2	6.0	50	9.3	14		
ND	7.5	10	13.8	11.9	9.9	50	16.5	19.8	ATV930U75N4	7.700/16.976
HD	5.5	7.5	10.5	9.2	7.6	50	12.7	19.1		
ND	11	15	19.8	17	14.1	50	23.5	28.2	ATV930D11N4	7.700/16.976
HD	7.5	10	14.1	12.5	10.4	50	16.5	24.8		
ND	15	20	27	23.3	19.4	50	31.7	38	ATV930D15N4	13.600/29.983
HD	11	15	20.6	18.1	15.0	50	23.5	35.3		
ND	18.5	25	33.4	28.9	24	50	39.2	47	ATV930D18N4	14.200/31.306
HD	15	20	27.7	24.4	20.3	50	31.7	47.6		
ND	22	30	39.6	34.4	28.6	50	46.3	55.6	ATV930D22N4	14.300/31.526
HD	18.5	25	34.1	29.9	24.9	50	39.2	58.8		
ND	30	40	53.3	45.9	38.2	50	61.5	73.8	ATV930D30N4	28.000/61.729
HD	22	30	40.5	35.8	29.8	50	46.3	69.5		
ND	37	50	66.2	57.3	47.6	50	74.5	89.4	ATV930D37N4	28.200/62.170
HD	30	40	54.8	48.3	40.2	50	61.5	92.3		
ND	45	60	79.8	69.1	57.4	50	88	105.6	ATV930D45N4	28.700/63.273
HD	37	50	67.1	59.0	49.1	50	74.5	111.8		
ND	55	75	97.2	84.2	70	50	106	127.2	ATV930D55N4	57.500/126.766
HD	45	60	81.4	71.8	59.7	50	88	132		
ND	75	100	131.3	112.7	93.7	50	145	174	ATV930D75N4	59.000/125.663
HD	55	75	98.9	86.9	72.2	50	106	159		
ND	90	125	156.2	135.8	112.9	50	173	207.6	ATV930D90N4	59.500/131.174
HD	75	100	134.3	118.1	98.2	50	145	217.5		
ND	220	350	397	324	247	50	427	512	ATV930C22N4	172.000/379.195
HD	160	250	296	246	187	50	302	453	(7)	

- (1) These values are given for an adjustable nominal switching frequency of 4 kHz for **ATV930U07N4...ATV930D45N4** or 2.5 kHz for **ATV930D55N4...C22N4**, for use in continuous operation. Above 2.5 or 4 kHz (depending on the rating), the drive will automatically reduce the switching frequency in the event of an excessive temperature rise. For continuous operation above the nominal switching frequency, derate the nominal drive current (see derating curves on our website www.schneider-electric.com).
- (2) Typical value for the indicated motor power and for the prospective line Isc.
- (3) For cabinet integration **ATV930...N4Z** products, see [pages 3/6 and 3/7](#) in the Cabinet integration chapter.
- (4) Values given for applications requiring a slight overload (up to 120%).
- (5) Values given for applications requiring a significant overload (up to 150%).
- (6) Category C2 EMC filter for **ATV930U07N4...D45N4**. Category C3 EMC filter above **ATV930D45N4**.
- (7) Product supplied as IP 00 for mounting in an enclosure. For IP 21/UL Type 1 wall mounting, a conformity kit should be ordered separately (see [page 2/11](#)).

Note: Consult the summary tables of possible drive, option, and accessory combinations (see [page 2/18](#)).

Variable speed drives

Altivar Process ATV900

Three-phase supply voltage: 380...480 V 50/60 Hz

2



ATV930C11N4C



ATV930C25N4C

380...480 V (-15...10%) IP 21/UL Type 1 drives - Wall mounting without braking unit										
Motor	Line supply				Altivar Process					
	Line current (2)		Apparent power	Prospective line Isc	Maximum continuous current (1)	Maximum transient current for 60 s	Reference (3)	Weight		
Power indicated on rating plate (1)	380 V	480 V	380 V							
ND: Normal duty (4)										
HD: Heavy duty (5)										
	kW	HP	A	A	kVA	kA	A	A	kg/lb	
With category C3 integrated EMC filter										
ND	55	75	97.2	84.2	70.0	50	106	127.2	ATV930D55N4C	56.500/124.561
HD	45	60	81.4	71.8	59.7	50	88	132		
ND	75	100	131.3	112.7	93.7	50	145	174.0	ATV930D75N4C	58.000/127.868
HD	55	75	98.9	86.9	72.2	50	106	159		
ND	90	125	156.2	135.8	112.9	50	173	207.6	ATV930D90N4C	58.500/128.970
HD	75	100	134.3	118.1	98.2	50	145	217.5		
ND	110	150	201	165	121.8	50	211	253	ATV930C11N4C	82.000/180.779
HD	90	125	170	143	102.6	50	173	259.5	(6)	
ND	132	200	237	213	161.4	50	250	300	ATV930C13N4C	82.000/180.779
HD	110	150	201	165	121.8	50	211	317	(6)	
ND	160	250	284	262	201.3	50	302	362	ATV930C16N4C	82.000/180.779
HD	132	200	237	213	161.4	50	250	375	(6)	
ND	220	350	397	324	247	50	427	512	ATV930C22N4C	172.000/319.195
HD	160	250	296	246	187	50	302	453	(6)	
ND	250	400	451	366	279	50	481	577	ATV930C25N4C	203.000/447.538
HD	200	300	365	301	229	50	387	581	(6)	
ND	315	500	569	461	351	50	616	739	ATV930C31N4C	203.000/447.538
HD	250	400	457	375	286	50	481	722	(6)	

(1) These values are given for a nominal switching frequency of 2.5 kHz for use in continuous operation. The switching frequency is adjustable for all ratings. Above 2.5 kHz, the drive will automatically reduce the switching frequency in the event of an excessive temperature rise. For continuous operation above the nominal switching frequency, derate the nominal drive current (see derating curves on our website www.schneider-electric.com).

(2) Typical value for the indicated motor power and for the maximum prospective line Isc.

(3) For cabinet integration **ATV930●●●N4Z** products, see [pages 3/6](#) and [3/6](#) in the Cabinet integration chapter.

(4) Values given for applications requiring a slight overload (up to 120%).

(5) Values given for applications requiring a significant overload (up to 150%).

(6) Product supplied as IP 00 for mounting in an enclosure. For IP 21/UL Type 1 wall mounting, a conformity kit should be ordered separately (see [page 2/11](#)).

Note: Consult the summary tables of possible drive, option, and accessory combinations (see [page 2/18](#)).



ATV950D15N4



ATV950D30N4



ATV950D55N4

380...480 V (-15...10%) IP 55 drives - Wall mounting with braking unit

Motor	Line supply						Altivar Process		Reference (3)	Weight
	Line current (2)		Apparent power	Prospective line Isc	Maximum continuous current (1)	Maximum transient current for 60 s	kg/lb			
Power indicated on rating plate (1)	380 V	480 V	380 V							
ND: Normal duty (4)										
HD: Heavy duty (5)										
	kW	HP	A	A	kVA	kA	A	A		
With category C2 or C3 integrated EMC filter (6)										
ND	0.75	1	1.5	1.3	1.1	50	2.2	2.6	ATV950U07N4	10.500/23.149
HD	0.37	0.5	0.9	0.8	0.7	50	1.5	2.3		
ND	1.5	2	3	2.6	2.2	50	4	4.8	ATV950U15N4	10.500/23.149
HD	0.75	1	1.7	1.5	1.2	50	2.2	3.3		
ND	2.2	3	4.3	3.8	3.2	50	5.6	6.7	ATV950U22N4	10.500/23.149
HD	1.5	2	3.1	2.9	2.4	50	4	6		
ND	3	–	5.8	5.1	4.2	50	7.2	8.6	ATV950U30N4	10.600/23.369
HD	2.2	3	4.5	4	3.3	50	5.6	8.4		
ND	4	5	7.6	6.7	5.6	50	9.3	11.2	ATV950U40N4	10.600/23.369
HD	3	–	6	5.4	4.5	50	7.2	10.8		
ND	5.5	7.5	10.4	9.1	7.6	50	12.7	15.2	ATV950U55N4	10.700/23.589
HD	4	5	8	7.2	6.0	50	9.3	14		
ND	7.5	10	13.8	11.9	9.9	50	16.5	19.8	ATV950U75N4	13.700/30.203
HD	5.5	7.5	10.5	9.2	7.6	50	12.7	19.1		
ND	11	15	19.8	17	14.1	50	23.5	28.2	ATV950D11N4	13.700/30.203
HD	7.5	10	14.1	12.5	10.4	50	16.5	24.8		
ND	15	20	27	23.3	19.4	50	31.7	38	ATV950D15N4	19.600/43.211
HD	11	15	20.6	18.1	15	50	23.5	35.3		
ND	18.5	25	33.4	28.9	24	50	39.2	47	ATV950D18N4	20.600/45.415
HD	15	20	27.7	24.4	20.3	50	31.7	47.6		
ND	22	30	39.6	34.4	28.6	50	46.3	55.6	ATV950D22N4	20.600/45.415
HD	18.5	25	34.1	29.9	24.9	50	39.2	58.8		
ND	30	40	53.3	45.9	38.2	50	61.5	73.8	ATV950D30N4	50.000/110.231
HD	22	30	40.5	35.8	29.8	50	46.3	69.5		
ND	37	50	66.2	57.3	47.6	50	74.5	89.4	ATV950D37N4	50.000/110.231
HD	30	40	54.8	48.3	40.2	50	61.5	92.3		
ND	45	60	79.8	69.1	57.4	50	88	105.6	ATV950D45N4	50.000/110.231
HD	37	50	67.1	59	49.1	50	74.5	111.8		
ND	55	75	97.2	84.2	70	50	106	127.2	ATV950D55N4	87.000/191.802
HD	45	60	81.4	71.8	59.7	50	88	132		
ND	75	100	131.3	112.7	93.7	50	145	174	ATV950D75N4	87.000/191.802
HD	55	75	98.9	86.9	72.2	50	106	159		
ND	90	125	156.2	135.8	112.9	50	173	207.6	ATV950D90N4	87.700/193.345
HD	75	100	134.3	118.1	98.2	50	145	217.5		

(1) These values are given for an adjustable nominal switching frequency of 4 kHz up to **ATV950D45N4** or 2.5 kHz for **ATV950D55N4...D90N4**, for use in continuous operation.

Above 2.5 or 4 kHz (depending on the rating), the drive will automatically reduce the switching frequency in the event of an excessive temperature rise. For continuous operation above the nominal switching frequency, derate the nominal drive current, see derating curves on our website www.schneider-electric.com.

(2) Typical value for the indicated motor power and for the prospective line Isc.

(3) Supplied with cable gland.

(4) Values given for applications requiring a slight overload (up to 120%).

(5) Values given for applications requiring a significant overload (up to 150%).

(6) Category C2 EMC filter for **ATV950U07N4...D45N4**. Category C3 EMC filter above **ATV950D45N4**.

Note: Consult the summary tables of possible drive, option and accessory combinations (see [page 2/18](#)).

Variable speed drives

Altivar Process ATV900

Three-phase supply voltage: 380...480 V 50/60 Hz

2



ATV950D15N4E



ATV950D30N4E



ATV950D55N4E

380...480 V (-15...10%) IP 55 drives - Wall mounting with braking unit										
Motor	Line supply						Altivar Process			
	Power indicated on rating plate (1)		Line current (2)		Apparent power	Prospective line Isc	Maximum continuous current (1)	Maximum transient current for 60 s	Reference (3)	Weight
	380 V	480 V	380 V							
ND: Normal duty (4)										
HD: Heavy duty (5)										
	kW	HP	A	A	kVA	kA	A	A		kg/lb
With disconnect switch and category C2 or C3 integrated EMC filter (6)										
ND	0.75	1	1.5	1.3	1.1	50	2.2	2.6	ATV950U07N4E	10.500/23.149
HD	0.37	0.5	0.9	0.8	0.7	50	1.5	2.3		
ND	1.5	2	3	2.6	2.2	50	4	4.8	ATV950U15N4E	10.500/23.149
HD	0.75	1	1.7	1.5	1.2	50	2.2	3.3		
ND	2.2	3	4.3	3.8	3.2	50	5.6	6.7	ATV950U22N4E	10.500/23.149
HD	1.5	2	3.1	2.9	2.4	50	4	6		
ND	3	-	5.8	5.1	4.2	50	7.2	8.6	ATV950U30N4E	10.600/23.369
HD	2.2	3	4.5	4	3.3	50	5.6	8.4		
ND	4	5	7.6	6.7	5.6	50	9.3	11.2	ATV950U40N4E	10.600/23.369
HD	3	-	6	5.4	4.5	50	7.2	10.8		
ND	5.5	7.5	10.4	9.1	7.6	50	12.7	15.2	ATV950U55N4E	10.700/23.589
HD	4	5	8	7.2	6.0	50	9.3	14		
ND	7.5	10	13.8	11.9	9.9	50	16.5	19.8	ATV950U75N4E	13.700/30.203
HD	5.5	7.5	10.5	9.2	7.6	50	12.7	19.1		
ND	11	15	19.8	17	14.1	50	23.5	28.2	ATV950D11N4E	13.700/30.203
HD	7.5	10	14.1	12.5	10.4	50	16.5	24.8		
ND	15	20	27	23.3	19.4	50	31.7	38	ATV950D15N4E	19.600/43.211
HD	11	15	20.6	18.1	15	50	23.5	35.3		
ND	18.5	25	33.4	28.9	24	50	39.2	47	ATV950D18N4E	20.600/45.415
HD	15	20	27.7	24.4	20.3	50	31.7	47.6		
ND	22	30	39.6	34.4	28.6	50	46.3	55.6	ATV950D22N4E	20.600/45.415
HD	18.5	25	34.1	29.9	24.9	50	39.2	58.8		
ND	30	40	53.3	45.9	38.2	50	61.5	73.8	ATV950D30N4E	52.000/114.640
HD	22	30	40.5	35.8	29.8	50	46.3	69.5		
ND	37	50	66.2	57.3	47.6	50	74.5	89.4	ATV950D37N4E	52.000/114.640
HD	30	40	54.8	48.3	40.2	50	61.5	92.3		
ND	45	60	79.8	69.1	57.4	50	88	105.6	ATV950D45N4E	52.000/114.640
HD	37	50	67.1	59	49.1	50	74.5	111.8		
ND	55	75	97.2	84.2	70	50	106	127.2	ATV950D55N4E	89.300/196.873
HD	45	60	81.4	71.8	59.7	50	88	132		
ND	75	100	131.3	112.7	93.7	50	145	174	ATV950D75N4E	89.300/196.873
HD	55	75	98.9	86.9	72.2	50	106	159		
ND	90	125	156.2	135.8	112.9	50	173	207.6	ATV950D90N4E	90.000/198.416
HD	75	100	134.3	118.1	98.2	50	145	217.5		

- (1) These values are given for an adjustable nominal switching frequency of 4 kHz up to **ATV950D45N4E** or 2.5 kHz for **ATV950D55N4E...D90N4E**, for use in continuous operation. Above 2.5 or 4 kHz (depending on the rating), the drive will automatically reduce the switching frequency in the event of an excessive temperature rise. For continuous operation above the nominal switching frequency, derate the nominal drive current (see derating curves on our website www.schneider-electric.com).
- (2) Typical value for the indicated motor power and for the prospective line Isc.
- (3) Supplied with cable gland.
- (4) Values given for applications requiring a slight overload (up to 120%).
- (5) Values given for applications requiring a significant overload (up to 150%).
- (6) Category C2 EMC filter for **ATV950U07N4E...D45N4E**. Category C3 EMC filter above **ATV950D45N4E**.

Note: Consult the summary tables of possible drive, option, and accessory combinations (see page 2/18).



ATV930D11Y6



ATV930D90Y6

500...690 V (-15...10%) IP 00 drives - Wall mounting with braking unit (1)

Motor		Line supply				Altivar Process		Reference	Weight			
Power indicated on rating plate (2)		Line current (3)		Apparent power	Maximum prospective line Isc	Max. continuous current (2)	Max. transient current for 60 s					
ND:	Normal duty (4)	500 V	690 V	690 V								
HD:	Heavy duty (5)	Supply voltage										
		500 V	690 V									
		kW	HP	kW	HP	A	A	kVA	kA	A	A	kg/lb
With category C3 integrated EMC filter												
ND	1.5	2	2.2	3	3.4	3.6	4.3	70	3.1	3.7	ATV930U22Y6	22.000/48.502
HD	1.1	1.5	1.5	2	2.6	2.6	3.1	70	2.4	3.6		
ND	2.2	3	3	-	4.7	4.8	5.7	70	4.2	5.0	ATV930U30Y6	22.000/48.502
HD	1.5	2	2.2	3	3.4	3.6	4.3	70	3.1	4.7		
ND	3	-	4	5	6.2	6.1	7.3	70	5.4	6.5	ATV930U40Y6	22.000/48.502
HD	2.2	3	3	-	4.7	4.8	5.7	70	4.2	6.3		
ND	4	5	5.5	7.5	7.9	8	9.6	70	7.2	8.6	ATV930U55Y6	22.000/48.502
HD	3	-	4	5	6.2	6.1	7.3	70	5.4	8.1		
ND	5.5	7.5	7.5	10	10.4	10.5	12.5	70	9.5	11.4	ATV930U75Y6	22.000/48.502
HD	4	5	5.5	7.5	7.9	8	9.6	70	7.2	10.8		
ND	7.5	10	11	15	13.6	14.7	17.6	70	13.5	16.2	ATV930D11Y6	22.000/48.502
HD	5.5	7.5	7.5	10	10.4	10.5	12.5	70	9.5	14.3		
ND	11	15	15	20	18.4	19.2	22.9	70	18	21.6	ATV930D15Y6	22.000/48.502
HD	7.5	10	11	15	13.6	14.7	17.6	70	13.5	20.3		
ND	15	20	18.5	25	23.1	23	27.5	70	24	28.8	ATV930D18Y6	22.000/48.502
HD	11	15	15	20	18.4	19.2	22.9	70	18	27.0		
ND	18.5	25	22	30	27.6	26	31.1	70	29	34.8	ATV930D22Y6	22.000/48.502
HD	15	20	18.5	25	23.2	23	27.5	70	24	36.0		
ND	22	30	30	40	32.1	32.8	39.2	70	34	40.8	ATV930D30Y6	22.000/48.502
HD	18.5	25	22	30	27.6	26	31.1	70	29	43.5		
ND	30	40	37	50	47.2	46.2	55.2	70	45	54.0	ATV930D37Y6	53.000/116.845
HD	22	30	30	40	37.7	38.5	46.0	70	34	51.0		
ND	37	50	45	60	55.6	54.4	65.0	70	55	66.0	ATV930D45Y6	53.000/116.845
HD	30	40	37	50	47.2	46.2	55.2	70	45	67.5		
ND	45	60	55	75	65.5	62.5	74.7	70	66	79.2	ATV930D55Y6	53.000/116.845
HD	37	50	45	60	55.6	54.4	65.0	70	55	82.5		
ND	55	75	75	100	82.7	87.7	104.8	70	83	99.6	ATV930D75Y6	53.000/116.845
HD	45	60	55	75	71	68.5	81.9	70	66	99.0		
ND	75	100	90	125	108.3	99.4	118.8	70	108	129.6	ATV930D90Y6	53.000/116.845
HD	55	75	75	100	82.7	87.7	104.8	70	83	124.5		

(1) Product supplied as IP 00 for mounting in an enclosure. For IP 20/UL Type1 wall mounting, an adaptation kit should be ordered separately.

(2) These values are given for use in continuous operation with a nominal switching frequency between 2.5 kHz (ATV930D37Y6...D90Y6) and 4 kHz (ATV930U22Y6...D30Y6). The switching frequency is adjustable from 1...4.9 kHz (ATV930D37Y6...D90Y6) to 2...8 kHz (ATV930U22Y6...D30Y6).

Above the nominal switching frequency, the drive will automatically reduce it in the event of an excessive temperature rise.

For continuous operation above the nominal switching frequency, nominal drive current should be derated according to the derating curves available on www.schneider-electric.com.

(3) Typical value for the indicated motor power and for the maximum prospective line Isc.

(4) Values given for applications requiring a slight overload (up to 120%).

(5) Values given for applications requiring a significant overload (up to 150%).

Note: Consult the summary tables of possible drive, option, and accessory combinations (see [page 2/18](#)).

Variable speed drives

Altivar Process ATV900

Three-phase supply voltage: 380...440 V 50/60 Hz



ATV930C16N4F

380...440 V (-15...10%) IP 21 drives - Floor standing without braking unit										
Motor		Line supply				Altivar Process				
Power indicated on rating plate (1)		Line current (2)		Apparent power 380 V	Maximum prospective line Isc	Maximum continuous current (1)	Maximum transient current for 60 s	Reference	Weight	
		380 V	400 V							
ND: Normal duty (3)										
HD: Heavy duty (4)										
kW	HP	A	A	kVA	kA	A	A		kg/lb	
With category C3 integrated EMC filter (5)										
ND	110	–	207	195	135	50	211	253	ATV930C11N4F	300.000/ 661.386
HD	90	–	174	164	113	50	173	260		
ND	132	–	250	232	161	50	250	300	ATV930C13N4F	300.000/ 661.386
HD	110	–	207	197	136	50	211	317		
ND	160	–	291	277	192	50	302	362	ATV930C16N4F	300.000/ 661.386
HD	132	–	244	232	161	50	250	375		
ND	200	–	369	349	242	50	370	444	ATV930C20N4F	400.000/ 881.848
HD	160	–	302	286	198	50	302	453		
ND	250	–	453	432	299	50	477	572	ATV930C25N4F	400.000/ 881.848
HD	200	–	369	353	244	50	370	555		
ND	315	–	566	538	373	50	590	708	ATV930C31N4F	400.000/ 881.848
HD	250	–	453	432	299	50	477	716		

- (1) These values are given for a nominal switching frequency of 2.5 kHz for use in continuous operation. The switching frequency is adjustable for all ratings. Above 2.5 kHz, the drive will automatically reduce the switching frequency in the event of an excessive temperature rise. For continuous operation above the nominal switching frequency, derate the nominal drive current (see derating curves on our website www.schneider-electric.com).
- (2) Typical value for the indicated motor power and for the maximum prospective line Isc.
- (3) Values given for applications requiring a slight overload (up to 120%).
- (4) Values given for applications requiring a significant overload (up to 150%).
- (5) Integrated motor chokes allowing a shielded motor cable length up to 300 m/984 ft in category C3 and an unshielded cable length up to 450 m/1,476 ft in category C4.

Note: Consult the summary tables of possible drive, option, and accessory combinations (see [page 2/18](#)).

PF151221



ATV950C31N4F

380...440 V (-15...10%) IP 54 drives - Floor standing without braking unit										
Motor		Line supply				Altivar Process				
Power indicated on rating plate		Line current (1)		Apparent power 380 V	Maximum prospective line Isc	Maximum continuous current	Maximum transient current for 60 s	Reference	Weight	
		380 V	400 V							
ND:	Normal duty (2)									
HD:	Heavy duty (3)									
kW	HP	A	A	kVA	kA	A	A		kg/lb	
With disconnect switch and category C3 integrated EMC filter (4)										
ND	110	–	207	195	135	50	211	253	ATV950C11N4F	310.000/ 683.433
HD	90	–	174	164	113	50	173	260		
ND	132	–	250	232	161	50	250	300	ATV950C13N4F	310.000/ 683.433
HD	110	–	207	197	136	50	211	317		
ND	160	–	291	277	192	50	302	362	ATV950C16N4F	310.000/ 683.433
HD	132	–	244	232	161	50	250	375		
ND	200	–	369	349	242	50	370	444	ATV950C20N4F	420.000/ 925.941
HD	160	–	302	286	198	50	302	453		
ND	250	–	453	432	299	50	477	572	ATV950C25N4F	420.000/ 925.941
HD	200	–	369	353	244	50	370	555		
ND	315	–	566	538	373	50	590	708	ATV950C31N4F	420.000/ 925.941
HD	250	–	453	432	299	50	477	716		

(1) Typical value for the indicated motor power and for the maximum prospective line Isc.

(2) Values given for applications requiring a slight overload (up to 120%).

(3) Values given for applications requiring a significant overload (up to 150%).

(4) Integrated motor chokes allowing a shielded motor cable length up to 300 m/984 ft in category C3 and an unshielded cable length up to 450 m/1,476 ft in category C4.

Note: Consult the summary tables of possible drive, option, and accessory combinations (see page 2/18).



VX5VPS3002



VX5VPS5002

Replacement parts

Description	For drive	Reference	Weight kg/lb
Fan kit for wall-mounting drives			
Power fan for IP 21 and IP 55 drives, bracket, instruction sheets	ATV930U07M3...U40M3, ATV930U07N4...U55N4, ATV950U07N4...U55N4, ATV950U07N4E...U55N4E	VX5VPS1001	—
	ATV930U55M3, ATV930U75N4...D11N4, ATV950U75N4...D11N4, ATV950U75N4E...D11N4E	VX5VPS2001	—
	ATV930U75M3...D11M3, ATV930D15N4...D22N4, ATV950D15N4...D22N4, ATV950D15N4E...D22N4E	VX5VPS3001	—
	ATV930U22Y6...D30Y6	VX5VPS3002	—
	ATV930D15M3...D22M3, ATV930D30N4...D45N4, ATV950D30N4...D45N4, ATV950D30N4E...D45N4E	VX5VPS4001	—
	ATV930D30M3...D45M3, ATV930D30M3C...D45M3C, ATV930D55N4...D90N4, ATV950D55N4...D90N4, ATV950D55N4E...D90N4E	VX5VPS5001	—
	ATV930D37Y6...D90Y6	VX5VPS5002	—
	ATV930D55M3C...D75M3C, ATV930C11N4C...C16N4C	VX5VPS6001	—
	ATV930C22N4, ATV930C22N4C...ATV930C31N4C	VZ3V1212 (1)	—
		VZ3V1213 (2)	—
Control fan for IP 55 drives, bracket, instruction sheets	ATV950U07N4...D22N4, ATV950U07N4E...D22N4E	VX5VP50A001	—
	ATV950D30N4...D90N4, ATV950D30N4E...D90N4E	VX5VP50BC001	—
Fan kit for floor-standing drives			
Power fan, bracket, instruction sheets	ATV930C11N4F...C31N4F, ATV950C11N4F...C31N4F	VX5VPM001	—
Door fan, bracket, instruction sheets	ATV930C11N4F...C31N4F, ATV950C11N4F...C31N4F	VX5VPM002	—
Enclosure grid filter pads			
223 x 223 mm/ 8.78 x 8.78 in. enclosure grid filter pad	ATV950C11N4F...C16N4F	NSYCAF223	—
291 x 291 mm/ 11.46 x 11.46 in. enclosure grid filter pad	ATV950C20N4F...C31N4F	NSYCAF291	—

(1) Fan power electronic for drive, with 1 unit for ATV930C22N4(C), 2 units for ATV930C25N4C, and 3 units for ATV930C31N4C.
 (2) Internal fan for drive, with 1 unit for ATV930C22N4(C), 2 units for ATV930C25N4C, and 3 units for ATV930C31N4C.

F19_ACC_CPSCCT7009



VW3A95116

Accessories for flange-mounting

Description	For use with (1)	Use with braking unit	Enclosure max. height (mm/in.)	Enclosure max. width (mm/in.)	Reference	Weight kg/lb
Mounting bracket for flange-mounting kit	NSYPTDS1, NSYPTDS2, NSYPTDS3	–	–	–	NSYAEFPFPTD	–
Flange-mounting kit for separate air flow (2)	ATV930U07M3...U40M3, ATV930U07N4...U55N4	–	360/14.17	235/9.25	NSYPTDS1	–
	ATV930U55M3, ATV930U75N4...D11N4	–	420/16.54	265/10.43	NSYPTDS2	–
	ATV930U75M3...D11M3, ATV930D15N4...D22N4	–	555/21.85	295/11.61	NSYPTDS3	–
	ATV930D15M3...D22M3, ATV930D30N4...D45N4	–	800/31.50	385/15.16	NSYPTDS4	–
	ATV930D30M3...D45M3, ATV930D55N4...D90N4	–	975/38.39	427/16.81	NSYPTDS5	–
	ATV930C11N4...C16N4, ATV930D55M3...D75M3	–	–	–	VW3A95116	–
	ATV930C22N4	–	–	–	VW3A9513	–
	ATV930C25N4, ATV930C31N4	Without braking unit	–	–	VW3A9514	–
		With braking unit	–	–	VW3A9515	–

F19_ACC_CPSCCT7006



VW3A9705

IP 20 and IP 21/UL Type 1 conformity kits

Description	For use with	Use with braking unit	Reference	Weight kg/lb
IP 20/UL Type 1 conformity kit	ATV930U22Y6...D30Y6	–	VW3A9705	–
	ATV930D37Y6...D90Y6	–	VW3A9706	–
IP 21/UL Type 1 conformity kit	ATV930D55M3...D75M3, ATV930C11N4...C16N4	–	VW3A9704	–
UL Type 1 conformity kit	ATV930C22N4	–	VW3A9212	–
	ATV930C25N4, ATV930C31N4	Without braking unit	VW3A9213	–

IP 31 conformity kit

Description	For use with	Use with braking unit	Reference	Weight kg/lb
IP 31 conformity kit	ATV930C22N4, ATV930C22N4C	–	VW3A9112	–
	ATV930C25N4C, ATV930C31N4C	Without braking unit	VW3A9113	–
		With braking unit	VW3A9114	–

(1) All accessories designed for use with N4 suffix articles ATV930...U75N4 and ATV930D11N4...D90N4 can also be used with their ..N4Z suffix articles equivalent.

(2) RUE-2192 patented system.



Graphic display terminal (example shows dynamic speed and torque)



Detected fault: The screen's red backlight is activated automatically



Embedded dynamic QR codes for contextual, instantaneous access to online help



Scanning the QR code from a smartphone or tablet

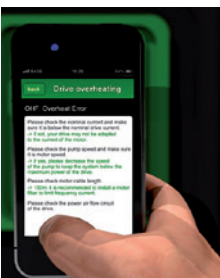

Instant access to online help

Graphic display terminal (supplied with the drive)

This terminal can be:

- Connected and mounted on the front of the drive
- Connected and mounted on an enclosure door using a remote mounting accessory
- Connected to a PC to exchange files via a Mini USB/USB connection (1)
- Connected to several drives in multidrop mode (see [page 2/15](#))

This terminal is used to:

- Control, adjust, and configure the drive
- Display current values (motor, I/O, and process data)
- Display graphic dashboards such as the energy consumption monitoring dashboard
- Store and download configurations (several configuration files can be stored in the 16 MB memory)
- Duplicate the configuration of one powered-up drive on another powered-up drive
- Copy configurations from a PC or drive and duplicate them on another drive (the drives must be powered on for the duration of the duplication operations)

Other characteristics:

- 24 integrated languages (complete alphabets) covering the majority of countries around the world (other languages can be added; please consult our website www.schneider-electric.com)
- 2-color backlit display (white and red); if an error is detected, the red backlight is activated automatically (function can be disabled)
- Operating range: -15...50 °C/+5...122 °F
- Degree of protection: IP 65
- Trend curves: Graphic display of changes over time in monitoring variables, energy data, and process data
- Embedded dynamic QR codes for contextual, instantaneous access to online help (diagnostics and settings, etc.) using a smartphone or tablet
- Real-time clock with 10-year backup battery providing data acquisition and event timestamping functions even when the drive is stopped

Description

Display:

- 8 lines, 240 x 160 pixels
- Displays bar charts, gauges, and trend charts
- 4 function keys to facilitate navigation and provide contextual links for enabling functions
- "STOP/RESET" button: Local control of motor stop command/clearing detected errors
- "RUN" button: Local control of motor run command
- Navigation buttons:
 - OK button: Saves the current value (ENT)
 - Turn ±: Increases or decreases the value, goes to the next or previous line
 - "ESC" button: Aborts a value, parameter, or menu to return to the previous selection
 - Home: Root menu
 - Information (i): Contextual help

References

Description	Reference	Weight kg/ lb
Graphic display terminal	VW3A1111	0.200/ 0.441

Communication accessory

Description	Reference	Weight kg/ lb
IP 20 WiFi dongle remote mounting of the Ethernet port for connection of WiFi equipment (PC, tablet, smartphone, etc.) powered by internal rechargeable battery	TCSEGWB13FA0	0.350/ 0.772

(1) Graphic display terminal used only as a handheld terminal.

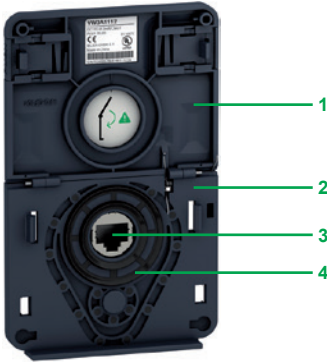

Remote mounting kit for mounting graphic display terminal on enclosure door (front panel)

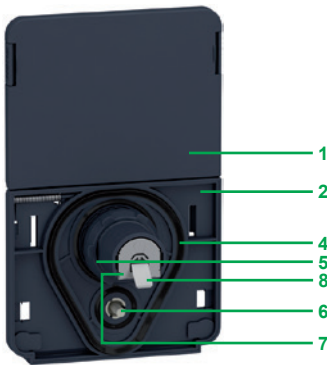

Remote mounting kit for graphic display terminal (rear panel)

Accessories for graphic display terminal

- Remote mounting kit for mounting on enclosure door with IP 65 degree of protection as standard

The kit comprises:

- Tightening tool (also sold separately under the reference ZB5AZ905)

- Cover plate to maintain IP 65 protection when there is no terminal connected
- Mounting plate
- RJ45 port for the graphic display terminal
- Seal
- Fixing nut
- Anti-rotation pin
- RJ45 port for connecting the remote-mounting cordset (10 m/32.81 ft maximum)
Cordsets should be ordered separately depending on the length required
- Grounding connector

Drilling a hole with a standard Ø 22 tool, as used for a pushbutton, allows the unit to be mounted without needing a cut-out in the enclosure (Ø 22.5 mm/Ø 0.89 in. drill hole).

References

Description	Length m/ ft	IP	Reference	Weight kg/ lb
Remote mounting kit Order with remote-mounting cordset VW3A1104R●●●	–	65	VW3A1112	–
Tightening tool for remote mounting kit	–	–	ZB5AZ905	0.016/ 0.035
Remote-mounting cordset equipped with 2 RJ45 connectors	1/ 3.28	–	VW3A1104R10	0.050/ 0.110
	3/ 9.84	–	VW3A1104R30	0.150/ 0.331
	5/ 16.40	–	VW3A1104R50	0.250/ 0.551
	10/ 32.81	–	VW3A1104R100	0.500/ 1.102
	–	–	TCSXCNAMUM3P	–
USB/Mini B USB cable for connecting the display terminal to a PC	–	–	TCSXCNAMUM3P	–
IP 65 remote mounting kit for Ethernet port (1) Ø 22 RJ45 female/female adapter with seal	–	65	VW3A1115	0.200/ 0.441
Set of 10 x IP55 shutters for ATV650: to keep IP55 protection level when the graphic display terminal is removed	–	55	VW3A1116	0.640/ 1.411

Multidrop connection accessories

These accessories are used to connect a graphic display terminal to several drives via a multidrop link. This multidrop connection uses the RJ45 terminal port on the front of the drive.

Connection accessories

Description	Sold in lots of	Unit reference	Weight kg/ lb
Modbus splitter box 10 RJ45 connectors and 1 screw terminal block	–	LU9GC3	0.500/ 1.102
Modbus T-junction boxes			
With 0.3 m/0.98 ft integrated cable	–	VW3A8306TF03	0.190/ 0.419
With 1 m/3.28 ft integrated cable	–	VW3A8306TF10	0.210/ 0.463
Modbus line terminator			
For RJ45 connector	R = 120 Ω C = 1 nf	VW3A8306RC	0.010/ 0.022

Cordsets (equipped with 2 RJ45 connectors)

Used for	Length m/ ft	Reference	Weight kg/ lb
Serial link	0.3/ 0.98	VW3A8306R03	0.025/ 0.055
	1/ 3.28	VW3A8306R10	0.060/ 0.132
	3/ 9.84	VW3A8306R30	0.130/ 0.287

(1) Used to connect a remote PC to the RJ45 port on an IP 21 drive mounted in an enclosure or on a wall. Drill hole with a standard Ø 22 tool, as used for a pushbutton. (Requires a remote-mounting cordset VW3A1104R●●● equipped with 2 RJ45 connectors).

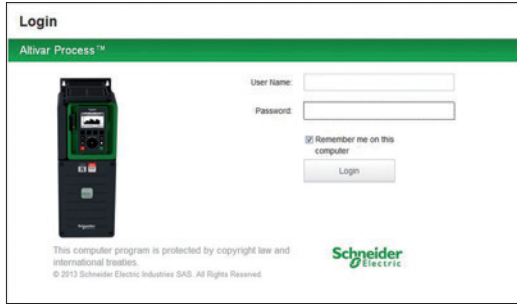

Login screen

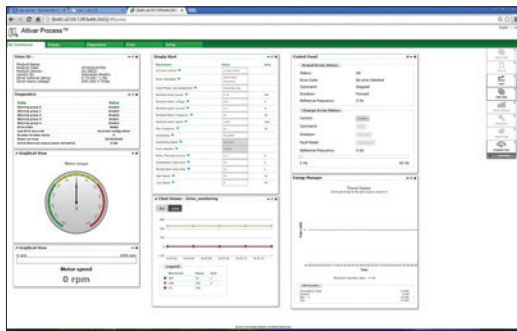

Customizable widgets

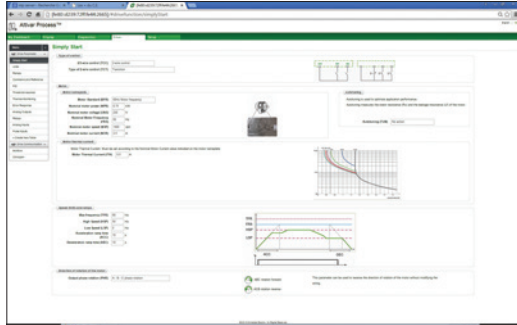

Drive adjustment parameters

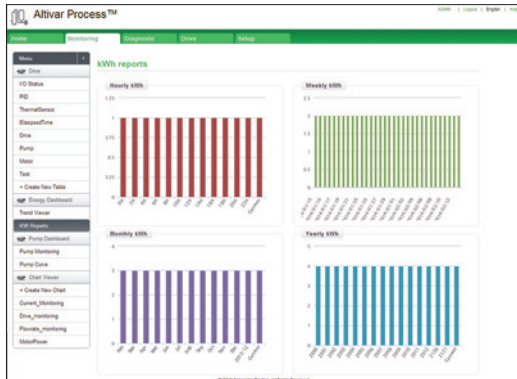

Energy dashboard

Web server

Presentation

- The Web server can be accessed:
 - For a drive not connected to an Ethernet network
 - Via an Ethernet cable or the Schneider Electric WiFi dongle (the drive then appears as a network device)
 - For a drive connected to an Ethernet network
 - From any point on the network by entering the drive IP address
- The Web server is used for:
 - Commissioning the drive (setting configuration parameters and enabling the main functions)
 - Monitoring energy and process data, as well as drive and motor data
 - Diagnostics (drive status, file transfer, detected error and warning logs)

Description

The Web server is structured around 5 tabs.

- “My dashboard” tab:
 - Configurable using a wide choice of widgets; groups all the information and dashboards selected by the user on one page
- “Display” tab:
 - Monitors energy indicators, efficiency, and performance
 - Displays process data
 - Monitors drive parameters and status
 - Shows the I/O state and assignment
- “Diagnostics” tab:
 - Drive status
 - Time and date-stamped warning and detected error logs
 - Network diagnostics
 - Access to drive self-tests
- “Drive” tab:
 - Access to the main drive adjustment parameters with contextual help
- “Setup” tab:
 - Network configuration
 - Access management
 - Transferring and retrieving drive configurations
 - Exporting data acquisition files and logs
 - Customizing pages (colors, logos, etc.)

Other characteristics:

- Ease of connection via the RJ45 port or WiFi connection
- Password-protected authentication (modifiable password; access rights can be configured by administrator)
- No downloads or installation necessary
- Web server can be disabled
- Works in a similar way on PCs, iPhones, iPads, Android systems, and the following major web browsers:
 - Internet Explorer® (version 8 or higher)
 - Google Chrome® (version 11 or higher)
 - Mozilla Firefox® (version 4 or higher)
 - Safari® (version 5.1.7 or higher)

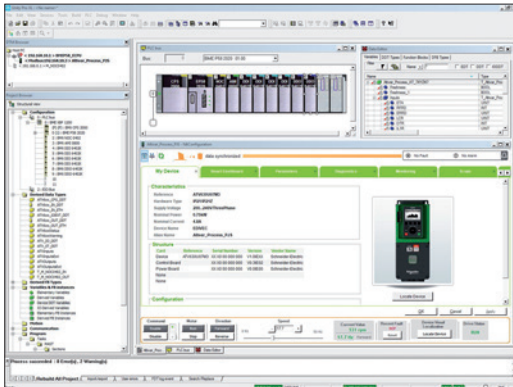

Altivar Process DTM in EcoStruxure Control Expert

DTM

Presentation

Using FDT/DTM technology it is possible to configure, control, and diagnose Altivar Process drives directly in EcoStruxure Control Expert and SoMove software by means of the same software brick (DTM).

FDT/DTM technology standardizes the communication interface between field devices and host systems. The DTM contains a uniform structure for managing drive access parameters.

Specific functions of the Altivar Process DTM

- Offline or online access to drive data
- Drive firmware updates
- Transfer of configuration files from and to the drive
- Customization (dashboard, My Menu, etc.)
- Access to drive parameters and option cards
- Oscilloscope function
- Graphic interface to assist with configuration of the Altivar Process functions
- Energy and process dashboards
- Graphic display of system operation and comparison with optimum operation (dynamic speed and torque curves)
- Detected error and warning logs (with timestamping)

Advantages of the DTM library in EcoStruxure Control Expert:

- Single tool for configuration, setup, and diagnostics
- Network scan for automatic recognition of network configuration
- Ability to add/remove, copy/paste configuration files from other drives in the same architecture
- Single input point for all parameters shared between the ePAC (programmable controller) and the Altivar Process drive
- Creation of drive profiles for implicit communication with the ePAC as well as dedicated profiles for programs with DFBs (derived function blocks)
- Integration in the fieldbus topology
- Drive configuration is an integral part of the EcoStruxure Control Expert project file (STU) and the archive file (STA)

Advantages of the DTM library in SoMove:

- Drive-oriented software environment
- Wired connection to the Ethernet communication port
- Standard cable (file transfer performance)
- Function block library for EcoStruxure Control Expert
- Display blocks for Vijeo Citect

■ Third-party software and downloads:

The Altivar Process DTM library is a flexible, open, and interactive tool that can be used in a third-party FDT.

DTMs can be downloaded from our website www.schneider-electric.com.

SoMove software

Presentation

SoMove software for PC is used to configure, set up, and maintain Altivar Process drives.

In addition to the functions offered by the Web server, SoMove software features the oscilloscope function for accurate display of data samples, as well as access to multi-drive applications.

The software can be connected to Altivar Process variable speed drives via:

- A Bluetooth® wireless connection with the Bluetooth/Modbus adapter TCSWAAC13FB
- Ethernet Modbus and WiFi connection with the WiFi dongle TCSEGWB13FA0 ■ Ethernet Modbus TCP connection

For more information on SoMove setup software, please consult the "SoMove: Setup Software" catalog available on our website www.schneider-electric.com.



SoMove software

Table showing possible combinations of options for ATV930...M3/M3C, ATV930...N4/N4C, and ATV930...N4Z drives

Main table with columns: Motor (kW, HP), Drive, Accessories (Fan kit, Flange-mounting kit, UL Type 1 (IP2X) conformity kit), Options (Passive filters (50 Hz), Passive filters (60 Hz), EMC filters, IP 21 kit for EMC filter, dv/dt filters, IP 21 kit for dv/dt filter, Sinus filter, IP 21 kit for sinus filter, Common mode filters (2)).

(1) In "Normal Duty", apply a derating of Pn-1 to the drive nominal power with a minimum switching frequency of 4 kHz. For example: an ATV630D75M3 drive with sinus filter can be used on a 55 kW motor.

(2) Fan power electronic for drive, with 1 unit for ATV930C22N4(C), 2 units for ATV930C25N4C, and 3 units for ATV930C31N4C.

(3) Without braking unit.

(4) With braking unit.

Table showing possible combinations of options for ATV930●●●Y6 drives

Motor kW HP	Drive	Accessories			Options					EMC filters	IP 21 kit for EMC filter	dv/dt filters	IP 20 kit for dv/dt filter	Sinus filter	IP 21 kit for sinus filter	Common mode filter	
		Fan kit	Flange-mounting kit	UL Type 1 conformity kit	Passive filters (50 Hz)		Passive filters (60 Hz)		Line chokes								
					THDi < 10%	THDi < 5%	THDi < 10%	THDi < 5%									THDi < 48%
Three-phase supply voltage: 500...690 V 50/60 Hz - IP 20/UL Type 1																	
1.5 2	ATV930U22Y6	VX5VPS3002	–	–	–	–	–	–	–	VW3A4551	(1)	–	VW3A5103, 5104	VW3A9612	VW3A5215	–	–
2.2 3	ATV930U30Y6	VX5VPS3002	–	–	–	–	–	–	–	VW3A4551	(1)	–	VW3A5103, 5104	VW3A9612	VW3A5215	–	–
3 –	ATV930U40Y6	VX5VPS3002	–	–	–	–	–	–	–	VW3A4551	(1)	–	VW3A5103, 5104	VW3A9612	VW3A5215	–	–
4 5	ATV930U55Y6	VX5VPS3002	–	–	–	–	–	–	–	VW3A4552	(1)	–	VW3A5103, 5104	VW3A9612	VW3A5215	–	–
5.5 7.5	ATV930U75Y6	VX5VPS3002	–	–	–	–	–	–	–	VW3A4552	(1)	–	VW3A5103, 5104	VW3A9612	VW3A5215	–	–
7.5 10	ATV930D11Y6	VX5VPS3002	–	–	–	–	–	–	–	VW3A4553	(1)	–	VW3A5104	VW3A9612	VW3A5216	–	–
11 15	ATV930D15Y6	VX5VPS3002	–	–	–	–	–	–	–	VW3A4553	(1)	–	VW3A5104	VW3A9612	VW3A5216	–	–
15 20	ATV930D18Y6	VX5VPS3002	–	–	–	–	–	–	–	VW3A4554	(1)	–	VW3A5104	VW3A9612	VW3A5216	–	–
18.5 25	ATV930D22Y6	VX5VPS3002	–	–	–	–	–	–	–	VW3A4554	(1)	–	VW3A5104	VW3A9612	VW3A5216	–	–
22 30	ATV930D30Y6	VX5VPS3002	–	–	–	–	–	–	–	VW3A4555	(1)	–	VW3A5104	VW3A9612	VW3A5217	–	–
30 40	ATV930D37Y6	VX5VPS5002	–	–	–	–	–	–	–	VW3A4555	(1)	–	VW3A5104	VW3A9612	VW3A5217	–	–
37 50	ATV930D45Y6	VX5VPS5002	–	–	–	–	–	–	–	VW3A4555	(1)	–	VW3A5104	VW3A9612	VW3A5218	–	–
45 60	ATV930D55Y6	VX5VPS5002	–	–	–	–	–	–	–	VW3A4556	(1)	–	VW3A5104	VW3A9612	VW3A5218	–	–
55 75	ATV930D75Y6	VX5VPS5002	–	–	–	–	–	–	–	VW3A4556	(1)	–	VW3A5104	VW3A9612	VW3A5219	–	–
75 100	ATV930D90Y6	VX5VPS5002	–	–	–	–	–	–	–	VW3A4556	(1)	–	VW3A5104	VW3A9612	VW3A5219	–	–
Three phase supply voltage: 380...480 V 50/60 Hz - IP 20																	
0.75 –	ATV930U07N4Z	VX5VPS1001	NSYPTDS1	–	VW3A46101	VW3A46120	VW3A46139	VW3A46158	–	–	VW3A4701	VW3A47901	VW3A5301	VW3A53902	VW3A5401	VW3A53901	VW3A5502
1.5 2	ATV930U15N4Z	VX5VPS1001	NSYPTDS1	–	VW3A46101	VW3A46120	VW3A46139	VW3A46158	–	–	VW3A4701	VW3A47901	VW3A5301	VW3A53902	VW3A5401	VW3A53901	VW3A5502
2.2 3	ATV930U22N4Z	VX5VPS1001	NSYPTDS1	–	VW3A46101	VW3A46120	VW3A46139	VW3A46158	–	–	VW3A4701	VW3A47901	VW3A5301	VW3A53902	VW3A5401	VW3A53901	VW3A5502
3 –	ATV930U30N4Z	VX5VPS1001	NSYPTDS1	–	VW3A46101	VW3A46120	VW3A46139	VW3A46158	–	–	VW3A4702	VW3A47902	VW3A5302	VW3A53902	VW3A5402	VW3A53901	VW3A5502
4 5	ATV930U40N4Z	VX5VPS1001	NSYPTDS1	–	VW3A46102	VW3A46121	VW3A46140	VW3A46159	–	–	VW3A4702	VW3A47902	VW3A5302	VW3A53902	VW3A5402	VW3A53901	VW3A5502
5.5 7.5	ATV930U55N4Z	VX5VPS1001	NSYPTDS1	–	VW3A46102	VW3A46121	VW3A46140	VW3A46159	–	–	VW3A4702	VW3A47902	VW3A5302	VW3A53902	VW3A5402	VW3A53901	VW3A5502
7.5 10	ATV930U75N4Z	VX5VPS2001	NSYPTDS2	–	VW3A46103	VW3A46122	VW3A46141	VW3A46160	–	–	VW3A4703	VW3A47903	VW3A5303	VW3A53902	VW3A5403	VW3A53902	VW3A5502
11 15	ATV930D11N4Z	VX5VPS2001	NSYPTDS2	–	VW3A46104	VW3A46123	VW3A46142	VW3A46161	–	–	VW3A4703	VW3A47903	VW3A5303	VW3A53902	VW3A5403	VW3A53902	VW3A5502
15 20	ATV930D15N4Z	VX5VPS3001	NSYPTDS3	–	VW3A46105	VW3A46124	VW3A46143	VW3A46162	–	–	VW3A4703	VW3A47903	VW3A5304	VW3A53903	VW3A5404	VW3A53903	VW3A5504
18.5 25	ATV930D18N4Z	VX5VPS3001	NSYPTDS3	–	VW3A46106	VW3A46125	VW3A46144	VW3A46163	–	–	VW3A4704	VW3A47904	VW3A5304	VW3A53903	VW3A5404	VW3A53903	VW3A5504
22 30	ATV930D22N4Z	VX5VPS3001	NSYPTDS3	–	VW3A46107	VW3A46126	VW3A46145	VW3A46164	–	–	VW3A4704	VW3A47904	VW3A5304	VW3A53903	VW3A5404	VW3A53903	VW3A5504
Three phase supply voltage: 380...480 V 50/60 Hz - IP 00																	
30 40	ATV930D30N4Z	VX5VPS4001	NSYPTDS4	–	VW3A46108	VW3A46127	VW3A46146	VW3A46165	–	–	VW3A4705	VW3A47905	VW3A5305	VW3A53905	VW3A5405	VW3A53904	VW3A5504
37 50	ATV930D37N4Z	VX5VPS4001	NSYPTDS4	–	VW3A46109	VW3A46128	VW3A46147	VW3A46166	–	–	VW3A4706	VW3A47906	VW3A5305	VW3A53905	VW3A5405	VW3A53904	VW3A5504
45 60	ATV930D45N4Z	VX5VPS1001	NSYPTDS4	–	VW3A46110	VW3A46129	VW3A46148	VW3A46167	–	–	VW3A4706	VW3A47906	VW3A5305	VW3A53905	VW3A5405	VW3A53904	VW3A5504
55 75	ATV930D55N4Z	VX5VPS5001	NSYPTDS5	–	VW3A46111	VW3A46130	VW3A46149	VW3A46168	–	–	VW3A4707	VW3A47907	VW3A5306	–	VW3A5406	–	VW3A5504
75 100	ATV930D75N4Z	VX5VPS5001	NSYPTDS5	–	VW3A46112	VW3A46131	VW3A46150	VW3A46169	–	–	VW3A4708	VW3A47908	VW3A5306	–	VW3A5406	–	VW3A5504
90 125	ATV930D90N4Z	VX5VPS5001	NSYPTDS5	–	VW3A46113	VW3A46132	VW3A46151	VW3A46170	–	–	VW3A4708	VW3A47908	VW3A5306	–	VW3A5406	–	VW3A5504
Pages	2/7	2/10	2/10	2/11	2/40	2/42	2/44	2/45	2/48		2/46	2/47	2/49	2/51	2/52	2/53	2/54

(1) Please, consult our Customer Care Center.

Table showing possible combinations of options for ATV950●●●N4/N4E drives

Motor kW HP	Drive	Accessories			Options				EMC filters	IP 21 kit for EMC filter	dv/dt filters	IP 21 kit for dv/dt filter	Sinus filter	IP 21 kit for sinus filter	Common mode filters (3)	
		Fan kit	Flange-mounting kit	Kit for IP 21 / UL Type 1 conformity	Passive filters (50 Hz)		Passive filters (60 Hz)									
Three-phase supply voltage: 380...480 V 50/60 Hz - IP 55																
					THDi < 10%	THDi < 5%	THDi < 10%	THDi < 5%								
0.75	1	ATV950U07N4	VX5VPS1001	-	-	VW3A46101 (1)	VW3A46120 (1)	VW3A46139 (1)	VW3A46158 (1)	VW3A4701	-	VW3A5301	-	VW3A5401 (1)	-	VW3A5502
1.5	2	ATV950U15N4	VX5VPS1001	-	-	VW3A46101 (1)	VW3A46120 (1)	VW3A46139 (1)	VW3A46158 (1)	VW3A4701	-	VW3A5301	-	VW3A5401 (1)	-	VW3A5502
2.2	3	ATV950U22N4	VX5VPS1001	-	-	VW3A46101 (1)	VW3A46120 (1)	VW3A46139 (1)	VW3A46158 (1)	VW3A4701	-	VW3A5301	-	VW3A5401 (1)	-	VW3A5502
3	-	ATV950U30N4	VX5VPS1001	-	-	VW3A46101 (1)	VW3A46120 (1)	VW3A46139 (1)	VW3A46158 (1)	VW3A4702	-	VW3A5302	-	VW3A5402 (1)	-	VW3A5502
4	5	ATV950U40N4	VX5VPS1001	-	-	VW3A46102 (1)	VW3A46121 (1)	VW3A46140 (1)	VW3A46159 (1)	VW3A4702	-	VW3A5302	-	VW3A5402 (1)	-	VW3A5502
5.5	7.5	ATV950U55N4	VX5VPS1001	-	-	VW3A46102 (1)	VW3A46121 (1)	VW3A46140 (1)	VW3A46159 (1)	VW3A4702	-	VW3A5302	-	VW3A5402 (1)	-	VW3A5502
7.5	10	ATV950U75N4	VX5VPS2001	-	-	VW3A46103 (1)	VW3A46122 (1)	VW3A46141 (1)	VW3A46160 (1)	VW3A4703	-	VW3A5303	-	VW3A5403 (1)	-	VW3A5502
11	15	ATV950D11N4	VX5VPS2001	-	-	VW3A46104 (1)	VW3A46123 (1)	VW3A46142 (1)	VW3A46161 (1)	VW3A4703	-	VW3A5303	-	VW3A5403 (1)	-	VW3A5502
15	20	ATV950D15N4	VX5VPS3001	-	-	VW3A46105 (1)	VW3A46124 (1)	VW3A46143 (1)	VW3A46162 (1)	VW3A4703	-	VW3A5304	-	VW3A5404 (1)	-	VW3A5504
18.5	25	ATV950D18N4	VX5VPS3001	-	-	VW3A46106 (1)	VW3A46125 (1)	VW3A46144 (1)	VW3A46163 (1)	VW3A4704	-	VW3A5304	-	VW3A5404 (1)	-	VW3A5504
22	30	ATV950D22N4	VX5VPS3001	-	-	VW3A46107 (1)	VW3A46126 (1)	VW3A46145 (1)	VW3A46164 (1)	VW3A4704	-	VW3A5304	-	VW3A5404 (1)	-	VW3A5504
30	40	ATV950D30N4	VX5VPS4001	-	-	VW3A46108 (1)	VW3A46127 (1)	VW3A46146 (1)	VW3A46165 (1)	VW3A4705	-	VW3A5305	-	VW3A5405 (1)	-	VW3A5504
37	50	ATV950D37N4	VX5VPS4001	-	-	VW3A46109 (1)	VW3A46128 (1)	VW3A46147 (1)	VW3A46166 (1)	VW3A4706	-	VW3A5305	-	VW3A5405 (1)	-	VW3A5504
45	60	ATV950D45N4	VX5VPS4001	-	-	VW3A46110 (1)	VW3A46129 (1)	VW3A46148 (1)	VW3A46167 (1)	VW3A4706	-	VW3A5305	-	VW3A5405 (1)	-	VW3A5504
55	75	ATV950D55N4	VX5VPS5001	-	-	VW3A46111 (1)	VW3A46130 (1)	VW3A46149 (1)	VW3A46168 (1)	VW3A4707	-	VW3A5306	-	VW3A5406 (1)	-	VW3A5504
75	100	ATV950D75N4	VX5VPS5001	-	-	VW3A46112 (1)	VW3A46131 (1)	VW3A46150 (1)	VW3A46169 (1)	VW3A4708	-	VW3A5306	-	VW3A5406 (1)	-	VW3A5504
90	125	ATV950D90N4	VX5VPS5001	-	-	VW3A46113 (1)	VW3A46132 (1)	VW3A46151 (1)	VW3A46170 (1)	VW3A4708	-	VW3A5306	-	VW3A5406 (1)	-	VW3A5504
Three-phase supply voltage: 380...480 V 50/60 Hz - IP 55 with Vario disconnect switch																
0.75	1	ATV950U07N4E	VX5VPS1001	-	-	VW3A46101 (1)	VW3A46120 (1)	VW3A46139 (1)	VW3A46158 (1)	VW3A4701	-	VW3A5301	-	VW3A5401 (1)	-	VW3A5502
1.5	2	ATV950U15N4E	VX5VPS1001	-	-	VW3A46101 (1)	VW3A46120 (1)	VW3A46139 (1)	VW3A46158 (1)	VW3A4701	-	VW3A5301	-	VW3A5401 (1)	-	VW3A5502
2.2	3	ATV950U22N4E	VX5VPS1001	-	-	VW3A46101 (1)	VW3A46120 (1)	VW3A46139 (1)	VW3A46158 (1)	VW3A4701	-	VW3A5301	-	VW3A5401 (1)	-	VW3A5502
3	-	ATV950U30N4E	VX5VPS1001	-	-	VW3A46101 (1)	VW3A46120 (1)	VW3A46139 (1)	VW3A46158 (1)	VW3A4702	-	VW3A5302	-	VW3A5402 (1)	-	VW3A5502
4	5	ATV950U40N4E	VX5VPS1001	-	-	VW3A46102 (1)	VW3A46121 (1)	VW3A46140 (1)	VW3A46159 (1)	VW3A4702	-	VW3A5302	-	VW3A5402 (1)	-	VW3A5502
5.5	7.5	ATV950U55N4E	VX5VPS1001	-	-	VW3A46102 (1)	VW3A46121 (1)	VW3A46140 (1)	VW3A46159 (1)	VW3A4702	-	VW3A5302	-	VW3A5402 (1)	-	VW3A5502
7.5	10	ATV950U75N4E	VX5VPS2001	-	-	VW3A46103 (1)	VW3A46122 (1)	VW3A46141 (1)	VW3A46160 (1)	VW3A4703	-	VW3A5303	-	VW3A5403 (1)	-	VW3A5502
11	15	ATV950D11N4E	VX5VPS2001	-	-	VW3A46104 (1)	VW3A46123 (1)	VW3A46142 (1)	VW3A46161 (1)	VW3A4703	-	VW3A5303	-	VW3A5403 (1)	-	VW3A5502
15	20	ATV950D15N4E	VX5VPS3001	-	-	VW3A46105 (1)	VW3A46124 (1)	VW3A46143 (1)	VW3A46162 (1)	VW3A4703	-	VW3A5304	-	VW3A5404 (1)	-	VW3A5504
18.5	25	ATV950D18N4E	VX5VPS3001	-	-	VW3A46106 (1)	VW3A46125 (1)	VW3A46144 (1)	VW3A46163 (1)	VW3A4704	-	VW3A5304	-	VW3A5404 (1)	-	VW3A5504
22	30	ATV950D22N4E	VX5VPS3001	-	-	VW3A46107 (1)	VW3A46126 (1)	VW3A46145 (1)	VW3A46164 (1)	VW3A4704	-	VW3A5304	-	VW3A5404 (1)	-	VW3A5504
30	40	ATV950D30N4E	VX5VPS4001	-	-	VW3A46108 (1)	VW3A46127 (1)	VW3A46146 (1)	VW3A46165 (1)	VW3A4705	-	VW3A5305	-	VW3A5405 (1)	-	VW3A5504
37	50	ATV950D37N4E	VX5VPS4001	-	-	VW3A46109 (1)	VW3A46128 (1)	VW3A46147 (1)	VW3A46166 (1)	VW3A4706	-	VW3A5305	-	VW3A5405 (1)	-	VW3A5504
45	60	ATV950D45N4E	VX5VPS4001	-	-	VW3A46110 (1)	VW3A46129 (1)	VW3A46148 (1)	VW3A46167 (1)	VW3A4706	-	VW3A5305	-	VW3A5405 (1)	-	VW3A5504
55	75	ATV950D55N4E	VX5VPS5001	-	-	VW3A46111 (1)	VW3A46130 (1)	VW3A46149 (1)	VW3A46168 (1)	VW3A4707	-	VW3A5306	-	VW3A5406 (1)	-	VW3A5504
75	100	ATV950D75N4E	VX5VPS5001	-	-	VW3A46112 (1)	VW3A46131 (1)	VW3A46150 (1)	VW3A46169 (1)	VW3A4708	-	VW3A5306	-	VW3A5406 (1)	-	VW3A5504
90	125	ATV950D90N4E	VX5VPS5001	-	-	VW3A46113 (1)	VW3A46132 (1)	VW3A46151 (1)	VW3A46170 (1)	VW3A4708	-	VW3A5306	-	VW3A5406 (1)	-	VW3A5504
Pages	2/5		2/10	-	-	2/40	2/42	2/44	2/45	2/46	-	2/49	-	2/52	-	2/54

I/O extension modules

Description	Reference	Page
Module with digital and analog I/O	VW3A3203	2/25
Module with relay outputs	VW3A3204	2/25

Encoder interface modules

Description	Reference	Page
Digital encoder interface module	VW3A3420	2/24
Analog encoder interface module	VW3A3422	2/24
Resolver interface module	VW3A3423	2/24
HTL encoder interface module	VW3A3424	2/24

List of fieldbus modules (2)

Description	Reference	Page
CANopen Daisy chain	VW3A3608	2/29
CANopen SUB-D	VW3A3618	2/29
CANopen screw terminal block	VW3A3628	2/30
PROFINET	VW3A3627	2/31
PROFIBUS DP V1	VW3A3607	2/31
POWERLINK Network	VW3A3619	2/31
EtherCAT	VW3A3601	2/31
DeviceNet	VW3A3609	2/31

(1) When used with ATV950U07N4/N4E...D90N4/N4E drives, the filter must be mounted in a separate enclosure to maintain IP 55 protection for the installation.
 (2) For module compatibility table, see opposite.

Module compatibility table

Module type	Digital and analog I/O VW3A3203 (4)	Relay outputs VW3A3204 (4)	Fieldbuses VW3A36●● (5)	Encoder interface modules VW3A3420, VW3A3422, VW3A3423 and VW3A3424 (5)
Digital and analog I/O VW3A3203				
Relay outputs VW3A3204				
Fieldbuses VW3A36●●				
Encoder interface modules VW3A3420, VW3A3422, VW3A3423 and VW3A3424				

█ Combination possible
 █ Combination impossible

(3) Maximum length of unshielded cable: 300 m. For other lengths or for shielded cables, see page 2/54.
 (4) Maximum combination involving two types of module is 2.
 (5) Maximum combination involving two types of module is 1.



VW3A3420 digital encoder interface module



VW3A3422 analog encoder interface module



VW3A3423 resolver interface module



VW3A3424 HTL encoder interface module

Presentation

Encoder interface modules are used for Flux Vector Control operation with sensor (FVC mode) for asynchronous motors, or for Vector Control operation with speed feedback (FSY mode) for synchronous motors.

They improve drive performance irrespective of the motor load state:

- Zero speed torque
- Accurate speed regulation
- Torque accuracy
- Shorter response times on a torque surge
- Improved dynamic performance in transient state

For asynchronous motors, in the other control modes (voltage vector control, voltage/frequency ratio), encoder interface modules improve static speed accuracy.

Depending on the model, encoder interface modules can also be used for monitoring, irrespective of the control type:

- Overspeed detection
- Load slipping detection

They can also transmit a reference value provided by the encoder input to the Altivar variable speed drive. This specific feature is used to synchronize the speed of several drives. The encoder options have a thermal sensor input to monitor one standard temperature sensor.

4 modules are available depending on the encoder technology:

- Encoder with digital output
- Encoder with analog output
- Resolver interface
- HTL encoder interface

The Altivar variable speed drive can only be equipped with one of the encoder interface modules. The interface encoder module is inserted in a dedicated slot. It is protected against encoder supply short circuits and overloads.

References

Description	Technology type	Used with encoder (1)	Power supply	Maximum current	Maximum cable length	Maximum operating frequency	Supported thermal sensors	Reference	Weight
			V ---	mA	m/ft	kHz			kg/lb
Digital encoder interface module	TTL (A/B/I)	XCC1●●●●●●R XCC1●●●●●●X	5, 12 or 24	250, 100	100/328	1,000	PTC (digital/linear), PT100, PT1000, Klixon	VW3A3420	0.150/ 0.331
	SSI	XCC2●●●●●●S●● XCC3●●●●●●S●●	5, 12 or 24	250, 100	50/164 (2)	1,000 (2)			
	EnDat® 2.2		5, 12	250, 100	50/164 (2)	1,000 (2)			
Analog encoder interface module	1 Vpp		5, 12 or 24	250, 100	100/328	100	PTC (digital/linear), PT100, PT1000, Klixon	VW3A3422	0.150/ 0.331
	SinCos Hiperface®		5, 12 or 24	250, 100	100/328	100			
Resolver interface module	Resolver	–	–	50	100/328	3...12	PTC (digital/linear), PT100, PT1000, Klixon	VW3A3423	0.150/ 0.331
HTL encoder interface module	HTL	–	12, 15 or 24	200, 175, 100	500/1640	300	–	VW3A3424	0.150/ 0.331

Connection accessories (3)

Description	Composition	Length m/ft	Reference	Weight kg/lb
Cordset				
Cordset equipped with 1 x 15-way high density male SUB-D connector for digital or analog encoder modules	–	1/3.28	VW3M4701	–

(1) To determine the complete reference, please refer to the "Detection for the automation solution - OsiSense" catalog or our website www.schneider-electric.com.

(2) With propagation delay compensation on EnDat® up to 100 m/328 ft and higher maximum frequencies possible, SSI 300 kHz up to 100m/328ft possible.

(3) See the complete list of connection accessories on our website www.schneider-electric.com.

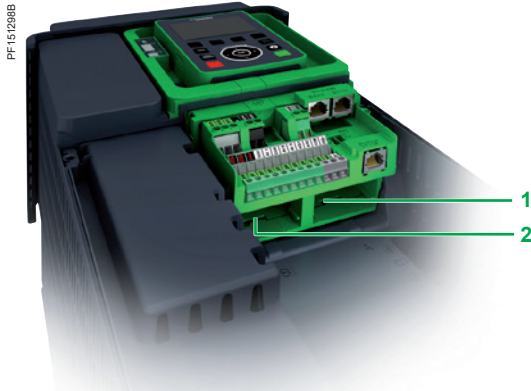

Altivar process drives slots for I/O extension modules

I/O extension modules

Presentation

By installing I/O extension modules Altivar Process drives can be adapted to meet the needs of applications that manage additional sensors or specific sensors.

2 extension modules are available:

- Module with digital and analog I/O
- Module with relay outputs

These modules are inserted in slots A and B on Altivar Process drives:

- 1 Slot A for I/O extension or fieldbus modules
- 2 Slot B for I/O extension modules and encoder modules

Module with digital and analog I/O

- 2 differential analog inputs configurable via software as current (0-20 mA/4-20 mA), or for PTC, PT100, or PT1000, 2 or 3-wire
 - 14-bit resolution
- 6 x 24 V $\overline{\text{V}}$ positive or negative digital inputs
 - Sampling: 1 ms max
- 2 assignable digital outputs
- 2 removable spring terminal blocks

Module with relay outputs

- 3 relay outputs with NO contacts
- 1 fixed screw terminal block

I/O extension modules

Description	I/O type				Reference	Weight kg/lb
	Digital inputs	Digital outputs	Analog inputs	Relay outputs		
Module with digital and analog I/O	6	2	2 (1)	–	VW3A3203	–
Module with relay outputs	–	–	–	3 (2)	VW3A3204	–

(1) Differential analog inputs configurable via software as current (0-20 mA/4-20 mA), or for PTC, PT100, or PT1000, 2 or 3-wire. When configured as PTC probe inputs, they must never be used to monitor the temperature of an ATEX motor for applications in explosive atmospheres. Please refer to the ATEX guide on our website www.schneider-electric.com.

(2) NO contacts.

Note: Digital and analog I/O modules and relay output modules can go in either slot A or slot B on Altivar Process drives. However, the drives cannot take 2 modules of the same type (e.g., 2 digital and analog I/O modules or 2 relay output modules).



VW3A3203



VW3A3204

Presentation

Altivar Process drives have 3 built-in RJ45 communication ports as standard:

- 1 EtherNet/IP and Modbus TCP dual port
- 1 serial port

Integrated communication protocols

Altivar Process drives integrate the EtherNet/IP and Modbus TCP and Modbus serial link communication protocols as standard.

■ EtherNet/IP and Modbus TCP dual port

This offers standard services regularly used in industrial networks: Connection to the Modbus TCP or EtherNet/IP network

- EtherNet IP adapter including standard CIP objects (AC/DC drive objects, CIP energy objects, etc.), compliant to ODVA specification
- The RSTP connection allows ring topology to help ensure continuity of service.
- Dual port allows daisy chain connection to simplify cabling and network infrastructure (no need to use a switch).
- Modbus TCP message handling is based on the Modbus protocol and is used to exchange process data with other network devices (e.g., a PLC). It provides Altivar Process drives with access to the Modbus protocol and to the high performance of the Ethernet network, which is the communication standard for numerous devices.
- SNMP (Simple Network Management Protocol) offers standard diagnostics services for network management tools.
- The FDR (Fast Device Replacement) service allows automatic reconfiguration of a new device installed to replace an existing device.
- Device integrity is reinforced by disabling some unused services as well as managing a list of authorized devices.
- Setup and adjustment tools (SoMove, EcoStruxure Control Expert with DTM) can be connected locally or remotely.
- The embedded Web server is used to display operating data and dashboards as well as to configure and perform system elements diagnostics from any web browser.

These numerous services offered by Altivar Process drives simplify integration into Schneider Electric process automation control systems like M580 ePAC or Foxboro Evo DCS.

■ Serial port

- Field network operation for exchanging data with other devices via the Modbus protocol
- Multidrop connection of the following HMIs and configuration tools:
 - The graphic display terminal supplied with the drive
 - A Magelis industrial HMI terminal
 - A APC with SoMove or EcoStruxure Control Expert setup software

The detailed specifications for the EtherNet/IP or serial communication ports, and the Modbus and Modbus TCP protocols are available on our website www.schneider-electric.com.

Description

- 1 2 x RJ45 EtherNet/IP and Modbus TCP port
- 2 RJ45 serial port
- 3 Slot A for I/O extension or fieldbus modules
- 4 Slot B for I/O extension modules and encoder modules
- 5 Removable screw terminal blocks for 24 V $\bar{\text{---}}$ power supply and integrated I/O
- 6 RJ45 serial link for HMI (graphic display terminal, Magelis terminal, etc.)

Altivar Process drives can only take one fieldbus module, in slot A **3** only. They cannot take 2 modules of the same type (e.g., 2 digital and analog I/O modules or 2 relay output modules). The drives can take one digital and analog I/O module and one relay output module in either slot A **3** or slot B **4**.

Note: The user manuals and description files (gsd, eds) for devices on the fieldbuses and networks are available on our website www.schneider-electric.com.

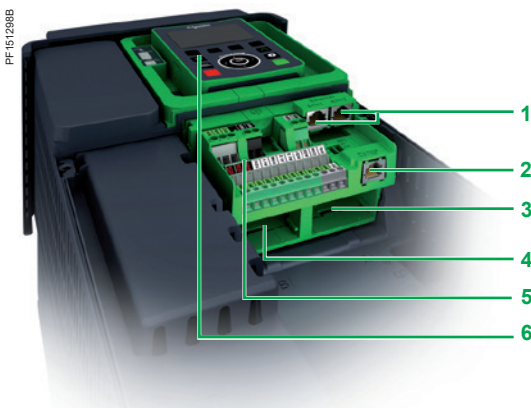

Altivar process drives ports and slots

Optional fieldbus modules

The Altivar Process drive can also be connected to other industrial fieldbuses and networks by using one of the fieldbus modules available as an option. Fieldbus modules are supplied in “cassette” format for ease of mounting/removal.

Dedicated fieldbus modules:

- CANopen:
- RJ45 Daisy Chain
- Sub-D
- Screw terminal block
- EtherCAT
- PROFINET
- PROFIBUS DP V1
- POWERLINK network
- DeviceNet

PROFINET and PROFIBUS DP V1 modules also support the Profidrive and CiA402 profiles.

It is possible to maintain communication using a separate power supply for the control and power sections. Monitoring and diagnostics via the network are possible even if there is no power supplied to the power section.

Functions

The drive functions can be accessed via the various communication networks:

- Configuration
- Adjustment
- Control
- Monitoring

Altivar Process drives offer a high degree of interfacing flexibility with the possibility to assign, by configuration, the different control sources (I/O, communication networks, and HMI terminal) to control functions in order to meet the requirements of complex applications.

Network services and parameters are configured using the SoMove drive setup software, or using EcoStruxure Control Expert software if the drive is being integrated into a PlantStruXure architecture.

Communication is monitored according to the specific criteria for each protocol. However, regardless of the protocol, it is possible to configure how the drive responds to a detected communication interruption, as follows:

- Define the type of stop when a communication interruption is detected
- Maintain last command received
- Fallback position at preset speed
- Ignore the detected communication interruption

2

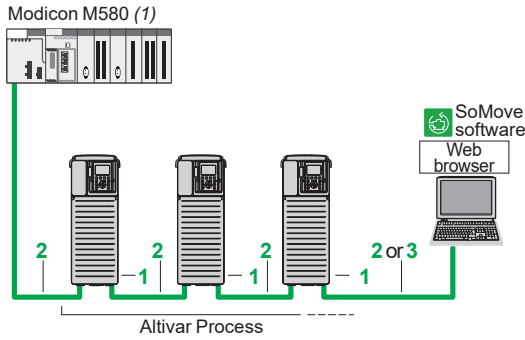

Example of connection on an EtherNet/IP network

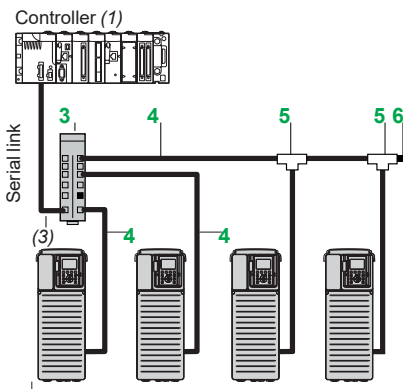

Example of serial link architecture

Integrated EtherNet/IP and Modbus TCP dual port

Description	Item	Length m/ ft	Unit reference	Weight kg/ lb
ConneXium cordsets (2)				
Straight shielded twisted pair cables equipped with 2 RJ45 connectors conforming to EIA/TIA-568 category 5 and IEC 11801/EN 50173-1, class D	2	2/ 6.56	490NTW00002	–
	5/	16.40	490NTW00005	–
	12/ 39.37		490NTW00012	–
Crossover shielded twisted pair cables equipped with 2 RJ45 connectors conforming to EIA/TIA-568 category 5 and IEC 11801/EN 50173-1, class D	3	5/ 16.40	490NTC00005	–
	15/ 49.21		490NTC00015	–
Straight shielded twisted pair cables equipped with 2 RJ45 connectors conforming to UL and CSA 22.1	2	2/ 6.56	490NTW00002U	–
	5/	16.40	490NTW00005U	–
	12/ 39.37		490NTW00012U	–
Crossover shielded twisted pair cables equipped with 2 RJ45 connectors conforming to UL and CSA 22.1	3	5/ 16.40	490NTC00005U	–
	15/ 49.21		490NTC00015U	–

Integrated serial port

Description	Item	Length m/ ft	Unit reference	Weight kg/ lb	
Connection accessories					
Splitter box 10 RJ45 connectors and 1 screw terminal block	3	–	LU9GC3	0.500/ 1.102	
Modbus T-junction boxes	With 0.3m/0.98 ft integrated cable	5	0.3/ 0.98	VW3A8306TF03	0.190/ 0.419
	With 1 m/3.28 ft integrated cable	5	1/ 3.28	VW3A8306TF10	0.210/ 0.463
Modbus line terminator (4)	For RJ45 connector R = 120 Ω C = 1 nf	6	–	VW3A8306RC	0.010/ 0.022
Cordsets equipped with 2 RJ45 connectors	4	0.3/ 0.98	VW3A8306R03	0.025/ 0.055	
	1/ 3.28		VW3A8306R10	0.060/ 0.132	
	3/ 9.84		VW3A8306R30	0.130/ 0.287	

(1) Please refer to the "Modicon automation platform" catalogs on our website www.schneider-electric.com.
 (2) Also exist in 40 and 80 m/131 and 262 ft lengths. For other ConneXium connection accessories, please consult our website www.schneider-electric.com.
 (3) Cable depends on the PLC.
 (4) Sold in lots of 2.

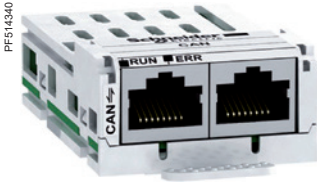

VW3A3608

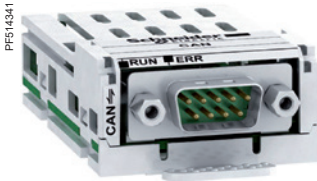

VW3A3618

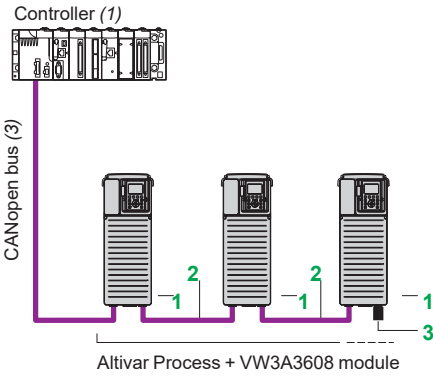

Optimized solution for daisy chain connection to the CANopen bus

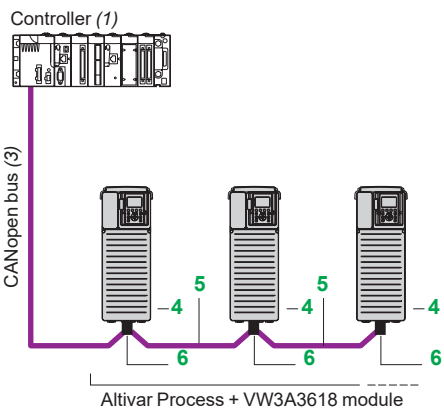

Example of connection to the CANopen bus via SUB-D connector

CANopen bus (1)

Description	Item	Length m/ ft	Unit reference	Weight kg/ lb
-------------	------	--------------------	-------------------	---------------------

Fieldbus module

CANopen Daisy chain module Ports: 2 RJ45 connectors	1	–	VW3A3608	–
---	---	---	----------	---

Connection to RJ45 connector (optimized solution for daisy chain connection on CANopen bus)

CANopen cordsets equipped with 2 RJ45 connectors	2	0.3/ 0.98	VW3CANCARR03	0.050/ 0.110
		1/ 3.28	VW3CANCARR1	0.500/ 1.102

CANopen line terminator for RJ45 connector	3	–	TCSCAR013M120	–
---	---	---	---------------	---

Fieldbus module

CANopen SUB-D module Ports: 1 x 9-way male SUB-D connector	4	–	VW3A3618	–
--	---	---	----------	---

Connection to SUB-D connector

CANopen cables (3) (4) Standard cable, CE mark Low smoke zero halogen. Flame-retardant (IEC 60332-1)	5	50/ 164.04	TSXCANCA50	4.930/ 10.869
		100/ 328.08	TSXCANCA100	8.800/ 19.401
		300/ 984.25	TSXCANCA300	24.560/ 54.145

CANopen cables (3) (4) UL certification, CE mark Flame-retardant (IEC 60332-2)	5	50/ 164.04	TSXCANCB50	3.580/ 7.893
		100/ 328.08	TSXCANCB100	7.840/ 17.284
		300/ 984.25	TSXCANCB300	21.870/ 48.215

CANopen cables (3) (4) Cable for harsh environments or mobile installations, CE mark Low smoke zero halogen Flame-retardant (IEC 60332-1)	5	50/ 164.04	TSXCANCD50	3.510/ 7.738
		100/ 328.08	TSXCANCD100	7.770/ 17.130
		300/ 984.25	TSXCANCD300	7.770/ 17.130

IP 20 straight CANopen connector (5) 9-way female SUB-D connector with line terminator that can be deactivated For connecting CAN-H, CAN-L, CAN-GND	6	–	TSXCANKCDF180T	0.049/ 0.108
--	---	---	----------------	-----------------

- (1) Altivar Process drives can only take one fieldbus module.
- (2) Please refer to the "Modicon automation platform" catalogs on our website www.schneider-electric.com.
- (3) Cable depends on the PLC.
- (4) Standard environment:
 - No particular environmental constraints
 - Operating temperature between +5 °C and +60 °C/+41 °F and +140 °F
 - Fixed installation
 Harsh environment:
 - Resistance to hydrocarbons, industrial oils, detergents, solder splashes
 - Relative humidity up to 100%
 - Saline atmosphere
 - Operating temperature between -10 °C and +70 °C/+14 °F and 158 °F
 - Significant temperature variations
- (5) Only straight connectors are compatible with Altivar Process drives.



VW3A3628

2

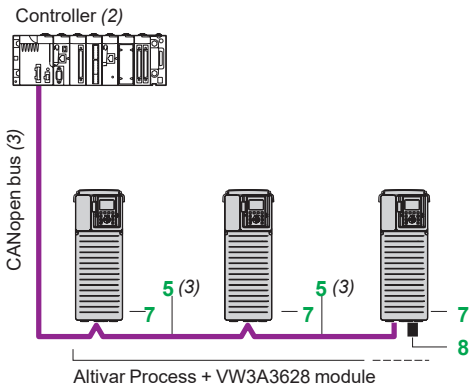

Example of connection to the CANopen bus with a screw terminal block

CANopen bus (continued) (1)

Description	Item	Length m/ ft	Unit reference	Weight kg/ lb
Fieldbus module				
CANopen module Port: 1 x 5-way screw terminal block	7	–	VW3A3628	–
Connection to screw terminal block				
CANopen IP 20 cordsets (3) equipped with 2 x 9-way female SUB-D connectors	5	0.3/ 0.98	TSXCANCADD03	0.091/ 0.201
Standard cable, C€ mark.		1/ 3.28	TSXCANCADD1	0.143/ 0.315
Low smoke zero halogen		3/ 9.84	TSXCANCBDD3	0.268/ 0.591
Flame-retardant (IEC 60332-1)		5/ 16.40	TSXCANCBDD5	0.400/ 0.882
IP 20 CANopen tap junction boxes equipped with: ■ 4 x 9-way male SUB-D connectors + screw terminal block for trunk cable tap link	–	–	TSXCANTDM4	0.196/ 0.432
■ Line terminator				
IP 20 CANopen tap junction boxes equipped with: ■ 2 screw terminal blocks for trunk cable tap link ■ 2 RJ45 connectors for connecting drives ■ 1 RJ45 connector for connecting a PC	–	–	VW3CANTAP2	–
CANopen line terminator for screw terminal connector (4)	8	–	TCSCAR01NM120	–

(1) Altivar Process drives can only take one fieldbus module.
 (2) Please refer to the "Modicon automation platform" catalogs on our website www.schneider-electric.com.
 (3) Cable depends on the PLC.
 (4) Sold in lots of 2.

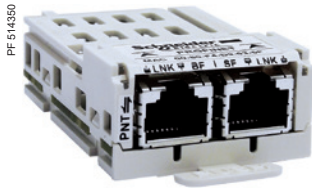

VW3A3627



VW3A3607



VW3A3619



VW3A3601

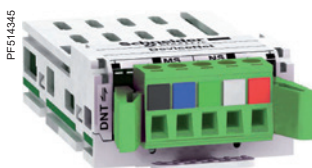

VW3A3609

PROFINET bus (1)			
Description	Reference	Weight kg/ lb	
Fieldbus module			
PROFINET module equipped with 2 RJ45 connectors	VW3A3627	0.290/ 0.639	

PROFIBUS DP V1 bus (1)			
Description	Reference	Weight kg/ lb	
Fieldbus module			
PROFIBUS DP V1 module Port: 1 x 9-way female SUB-D connector Conforming to PROFIBUS DP V1 Profiles supported: ■ CiA 402 drive ■ Profidrive Offers several message handling modes based on DP V1	VW3A3607	0.140/ 0.309	

SUB-D connection			
Description	Reference	Weight kg/ lb	
IP 20 straight connectors (2) for Profibus module	LU9AD7		–

POWERLINK network (3)			
Description	Reference	Weight kg/ lb	
Ethernet POWERLINK communication module Port: 2 RJ45 connectors	VW3A3619	0.300/ 0.660	

EtherCAT bus (1)			
Description	Reference	Weight kg/ lb	
Fieldbus module			
EtherCAT module equipped with 2 RJ45 connectors	VW3A3601	0.290/ 0.639	

DeviceNet bus (1)			
Description	Reference	Weight kg/ lb	
Fieldbus module			
DeviceNet module Port: 1 removable 5-way screw connector Profiles supported: ■ CIP AC DRIVE ■ CiA 402 drive	VW3A3609	0.300/ 0.661	

Connection accessories			
Description	Length m/ft	Reference	Weight kg/ lb
Cordset equipped with 1 x 15-way high density male SUB-D connector for digital or analog encoder modules	1/3.28	VW3M4701	–

(1) Altivar Process drives can only take one fieldbus module.
 (2) Only straight connectors are compatible with Altivar Process drives.
 (3) Minimum Altivar Process firmware version compatible with Powerlink module: v1.8.

Presentation

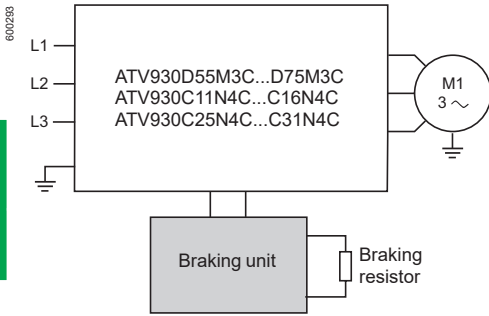

Altivar Process drive with braking unit

Braking units allow Altivar Process drives to operate while braking to a standstill or during “generator” operation, by dissipating the energy in the braking resistor.

ATV930U07M3...D45M3, ATV930U07N4...D90N4, ATV930C22N4, ATV930U22Y6...D90Y6 and ATV950U07N4...D90N4 drives have a built-in dynamic brake transistor.

For ATV930D55M3C...D75M3C, ATV930C11N4C...C16N4C and ATV930C25N4C...C31N4C drives, a braking unit must be used.

Braking units provide IP 20 protection. Thermal protection is given by an integrated temperature probe.

Applications

High-inertia machines, machines with slow and fast cycles, high-power machines performing vertical movements.

References

For drives	Power		Losses	Cable (drive-braking unit)		Cable (braking unit-resistors)		Percentage of conduction time	Minimum resistor value	Reference	Weight
	Continuous	Maximum		Cross-section	Maximum length	Cross-section	Maximum length				
	kW	kW	W	mm ²	m	mm ²	m	%	Ohms		kg/lb
Supply voltage: 200...240 V 50/60 Hz											
ATV930D55M3C ...D75M3C	60	80	400	3 x 120	10	3 x 120	10	5% at 150 kW 15% at 120 kW 50% at 95 kW	1.4	VW3A7106	28.000/ 61.729
Supply voltage: 380...480 V 50/60 Hz											
ATV930C11N4C ...C16N4C	100	160	400	2 x 120	5	2 x 120	5	5% at 320 kW 15% at 250 kW 50% at 200 kW	2.5	VW3A7105	28.000/ 61.729
ATV930C25N4C ATV930C31N4C	200	420	550	— (1)	— (1)	2 x 95	50	5% at 420 kW 15% at 320 kW 50% at 250 kW	1	VW3A7101	30.000/ 66.139

(1) For the ATV930C25N4C and ATV930C31N4C variable speed drives, the braking unit is connected to the drive with internal connections.

PF161255

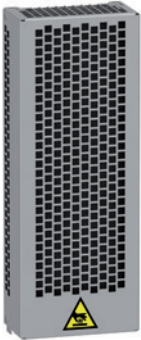

VW3A7741

Presentation

Braking resistors allow Altivar Process drives to operate while braking to a standstill, by dissipating the braking energy. They enable maximum transient braking torque.

Braking resistors are designed to be located outside the enclosure, but should not inhibit natural cooling. Air inlets and outlets must not be obstructed in any way. The air must be free of dust, corrosive gas, and condensation.

Several resistor models are available, depending on the drive rating:

- With IP 20 and IP 23 casing and thermal protection provided by temperature-controlled switch or by the drive

The internal circuits of Altivar Process drives rated 90 kW or less have a built-in dynamic brake transistor.

An external braking unit is necessary for wall-mounting Altivar Process drives between 110 kW and 315 kW at 400...480 V as well as 55 kW and 75 kW at 200...240 V.

Applications

Braking resistors are designed for a defined cycle (see the 3 cycle types defined below).

Depending on your own applications and cycles, you can use these resistors or define a new value.

- Braking resistors for light braking cycles for machines with cycles and inertia. The braking power is limited to 1.5 Tn for 0.8 s every 40 s.
- Braking resistors for medium braking cycles for machines with high inertia and conveyors. The braking power is limited to 1.35 Tn for 4 s every 40 s.
- Braking resistors for severe braking cycles for machines with very high inertia and vertical movements (hoisting). The braking power is limited to 1.65 Tn for 6 s and Tn for 54 s every 120 s.

2

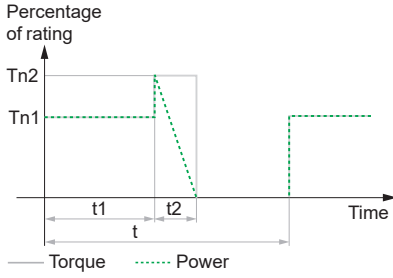

Light Cycle	
$t = 40\text{ s}$	t : period
$t1 = 0\text{ s}$	$Tn1$: braking torque
$t2 = 0.8\text{ s}$	$Tn2$: braking torque
$Tn1 = 0$	Tn : nominal torque
$Tn2 = 1.5 \times Tn$	

Light braking cycle

References for a light braking cycle						
For drives	Degree of protection of the resistor	Ohmic value at 20 °C/ 68 °F	Average power available at 50 °C/ 122 °F (1)	Quantity required per drive	Reference	Weight
		Ω	kW			kg/lb
Supply voltage: 200...240 V or 380...480 V 50/60 Hz						
ATV930U07M3	IP20	100	0.1	1	VW3A7730	1.500/ 3.307
ATV930U07N4...U40N4						
ATV950U07N4...U40N4						
ATV950U07N4E...U40N4E						
ATV930U15M3...U22M3	IP20	60	0.16	1	VW3A7731	2.000/ 4.409
ATV930U55N4...U75N4						
ATV950U55N4...U75N4						
ATV950U55N4E...U75N4E						
ATV930U30M3...U40M3	IP20	28	0.3	1	VW3A7732	3.000/ 6.614
ATV930D11N4...D15N4						
ATV950D11N4...D15N4						
ATV950D11N4E...D15N4E						
ATV930U55M3...U75M3	IP20	16	1.1	1	VW3A7733	4.000/ 8.818
ATV930D18N4...D30N4						
ATV950D18N4...D30N4						
ATV950D18N4E...D30N4E						
ATV930D11M3	IP20	10	1.1	1	VW3A7734	5.500/ 12.125
ATV930D37N4...D45N4						
ATV950D37N4...D45N4						
ATV950D37N4E...D45N4E						
ATV930D15M3	IP20	8	1.1	1	VW3A7735	5.500/ 12.125
ATV930D55N4						
ATV950D55N4						
ATV950D55N4E						
ATV930D18M3...D22M3	IP23	5	1.9	1	VW3A7736	18.000/ 39.683
ATV930D75N4...D90N4						
ATV950D75N4...D90N4						
ATV950D75N4E...D90N4E						
ATV930D30M3...D45M3	IP23	2.5	3.2	1	VW3A7737	21.000/ 46.297
ATV930C11N4C...C16N4C						
ATV930C31N4C	IP23	2.5	3.2	2		
ATV930D55M3C...D75M3C	IP23	1.4	1.5	1	VW3A7738	16.000/ 35.274
ATV930C22N4	IP23	1.4	5.1	1	VW3A7748	29.000/ 69.934
ATV930C25N4C						

(1) Load factor for resistors: The value of the average power that can be dissipated at 50 °C/122 °F from the resistor into the casing is determined for a load factor during braking that corresponds to the majority of normal applications:

- Normal duty: 0.8 s braking with a 1.2 Tn braking torque for a 40 s cycle
- Heavy duty: 0.8 s braking with a 1.5 Tn braking torque for a 40 s cycle

PF151251A



VW3A7736

References for a light braking cycle (continued)

For drives	Degree of protection of the resistor	Ohmic value at 20 °C/ 68 °F	Average power available at 50 °C/ 122 °F (1)	Quantity required per drive	Reference	Weight
		Ω	kW			kg/ lb
Supply voltage: 500...690 V 50/ 60 Hz						
ATV930U22Y6	IP20	100	0.1	1	VW3A7730	1.500/ 3.306
ATV930U30Y6	IP20	100	0.1	1	VW3A7730	1.500/ 3.306
ATV930U40Y6	IP20	100	0.1	1	VW3A7730	1.500/ 3.306
ATV930U55Y6	IP20	100	0.1	1	VW3A7730	1.500/ 3.306
ATV930U75Y6	IP20	60	0.16	1	VW3A7731	1.800/ 3.968
ATV930D11Y6	IP20	28	0.3	1	VW3A7732	2.700/ 5.952
ATV930D15Y6	IP20	28	0.3	1	VW3A7732	2.700/ 5.952
ATV930D18Y6	IP20	28	0.3	1	VW3A7732	2.700/ 5.952
ATV930D22Y6	IP20	16	0.96	1	VW3A7733	3.800/ 8.377
ATV930D30Y6	IP20	16	0.96	1	VW3A7733	3.800/ 8.377
ATV930D37Y6	IP20	10	0.96	1	VW3A7734	4.300/ 9.479
ATV930D45Y6	IP20	10	0.96	1	VW3A7734	4.300/ 9.479
ATV930D55Y6	IP20	10	0.96	1	VW3A7734	4.300/ 9.479
ATV930D75Y6	IP23	5	1.9	1	VW3A7736	18.000/ 39.683
ATV930D90Y6	IP23	5	1.9	1	VW3A7736	18.000/ 39.683

(1) Load factor for resistors: The value of the average power that can be dissipated at 50 °C/ 122 °F from the resistor into the casing is determined for a load factor during braking that corresponds to the majority of normal applications:

- Normal duty: 0.8 s braking with a 1.2 T_n braking torque for a 40 s cycle
- Heavy duty: 0.8 s braking with a 1.5 T_n braking torque for a 40 s cycle

2

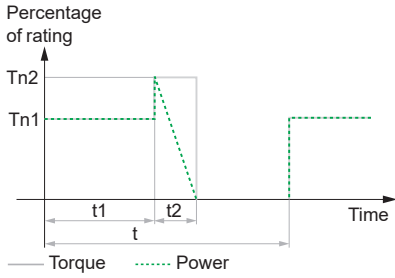

Medium Cycle	
$t = 40\text{ s}$	t : period
$t1 = 0\text{ s}$	$Tn1$: braking torque
$t2 = 4\text{ s}$	$Tn2$: braking torque
$Tn1 = 0$	Tn : nominal torque
$Tn2 = 1.35 \times Tn$	

Medium braking cycle

References for a medium braking cycle						
For drives	Degree of protection of the resistor	Ohmic value at 20 °C/ 68 °F	Average power available at 50 °C/ 122 °F (1)	Quantity required per drive	Reference	Weight
		Ω	kW			kg/lb
Supply voltage: 200...240 V or 380...480 V 50/60 Hz						
ATV930U07M3 ATV930U07N4...U15N4 ATV950U07N4...U15N4 ATV950U07N4E...U15N4E	IP20	100	0.1	1	VW3A7730	1.500/ 3.307
ATV930U15M3...U22M3	IP20	60	0.16	1	VW3A7731	2.000/ 4.409
ATV930U30M3...U40M3	IP20	28	0.3	1	VW3A7732	3.000/ 6.614
ATV930U55M3...U75M3	IP20	16	1.1	1	VW3A7733	4.000/ 8.818
ATV930D11M3	IP20	10	1.1	1	VW3A7734	5.500/ 12.125
ATV930D15M3	IP20	8	1.1	1	VW3A7735	5.500/ 12.125
ATV930D18M3...D22M3	IP23	5	1.9	1	VW3A7736	18.000/ 39.684
ATV930D30M3...D45M3	IP23	2.5	3.2	1	VW3A7737	20.000/ 44.092
ATV930U22N4...U40N4 ATV950U22N4...U40N4 ATV950U22N4E...U40N4E	IP20	100	0.26	1	VW3A7740	2.500/ 5.512
ATV930U55N4...U75N4 ATV950U55N4...U75N4 ATV950U55N4E...U75N4E	IP20	60	0.5	1	VW3A7741	4.500/ 9.921
ATV930D11N4...D15N4 ATV950D11N4...D15N4 ATV950D11N4E...D15N4E	IP20	28	1.1	1	VW3A7742	4.000/ 8.818
ATV930D18N4...D30N4 ATV950D18N4...D30N4 ATV950D18N4E...D30N4E	IP20	16	2.2	1	VW3A7743	7.000/ 15.432
ATV930D37N4...D45N4 ATV950D37N4...D45N4 ATV950D37N4E...D45N4E	IP20	10	3.4	1	VW3A7744	11.500/ 25.353
ATV930D55N4 ATV950D55N4 ATV950D55N4E	IP23	8	3.8	1	VW3A7745	23.000/ 50.706
ATV930D75N4...D90N4 ATV950D75N4...D90N4 ATV950D75N4E...D90N4E	IP23	5	6.9	1	VW3A7746	27.000/ 59.525
ATV930C11N4C...C16N4C	IP23	2.5	11	1	VW3A7747	43.000/ 94.799
ATV930D55M3C...D75M3C	IP23	1.4	5.1	1	VW3A7748	25.000/ 55.116
ATV930C22N4 ATV930C25N4C...C31N4C	IP23	1.4	29	1	VW3A7757	121.000/ 69.934

(1) Load factor for resistors: The value of the average power that can be dissipated at 50 °C/122 °F from the resistor into the casing is determined for a load factor during braking that corresponds to the majority of normal applications:

- Normal duty: 4 s braking with a 1.35 Tn braking torque for a 40 s cycle
- Heavy duty: 4 s braking with a 1.65 Tn braking torque for a 40 s cycle

References for a medium braking cycle (continued)						
For drives	Degree of protection of the resistor	Ohmic value at 20 °C/ 68 °F	Average power available at 50 °C/ 122 °F (1)	Quantity required per drive	Reference	Weight
		Ω	kW			kg/lb
Supply voltage: 500...690 V 50/ 60 Hz						
ATV930U22Y6	IP20	100	0.26	1	VW3A7740	2.500/ 5.511
ATV930U30Y6	IP20	100	0.26	1	VW3A7740	2.500/ 5.511
ATV930U40Y6	IP20	100	0.26	1	VW3A7740	2.500/ 5.511
ATV930U55Y6	IP20	60	0.5	1	VW3A7741	3.800/ 8.377
ATV930U75Y6	IP20	60	0.5	1	VW3A7741	3.800/ 8.377
ATV930D11Y6	IP20	28	0.96	1	VW3A7742	4.200/ 9.259
ATV930D15Y6	IP20	28	0.96	1	VW3A7742	4.200/ 9.259
ATV930D18Y6	IP20	16	1.9	1	VW3A7743	6.400/ 14.109
ATV930D22Y6	IP20	16	1.9	1	VW3A7743	6.400/ 14.109
ATV930D30Y6	IP20	16	1.9	1	VW3A7743	6.400/ 14.109
ATV930D37Y6	IP20	10	2.9	1	VW3A7744	9.000/ 19.841
ATV930D45Y6	IP20	10	2.9	1	VW3A7744	9.000/ 19.841
ATV930D55Y6	IP23	8	3.8	1	VW3A7745	25.500/ 56.217
ATV930D75Y6	IP23	5	6.9	1	VW3A7746	30.500/ 67.240
ATV930D90Y6	IP23	5	6.9	1	VW3A7746	30.500/ 67.240

(1) Load factor for resistors: The value of the average power that can be dissipated at 50 °C/122 °F from the resistor into the casing is determined for a load factor during braking that corresponds to the majority of normal applications:

- Normal duty: 4 s braking with a 1.35 T_n braking torque for a 40 s cycle
- Heavy duty: 4 s braking with a 1.65 T_n braking torque for a 40 s cycle

2

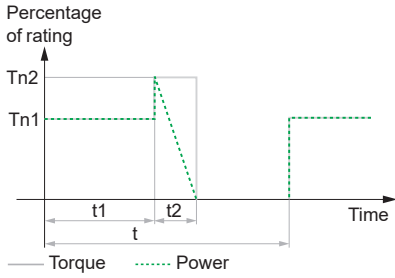

Severe Cycle	
$t = 120\text{ s}$	t : period
$t1 = 54\text{ s}$	$Tn1$: braking torque
$t2 = 6\text{ s}$	$Tn2$: braking torque
$Tn1 = Tn$	Tn : nominal torque
$Tn2 = 1.65 \times Tn$	

Severe braking cycle

References for a severe braking cycle (hoisting applications)

For drives	Degree of protection of the resistor	Ohmic value at 20 °C/ 68 °F	Average power available at 50 °C/ 122 °F (1)	Quantity required per drive	Reference	Weight
		Ω	kW			kg/lb
Supply voltage: 200...240 V or 380...480 V 50/60 Hz						
ATV930U07M3	IP20	100	0.26	1	VW3A7740	2.500/ 5.512
ATV930U15M3	IP20	60	0.5	1	VW3A7741	4.500/ 9.921
ATV930U22M3	IP20	60	3.4	1	VW3A7751	10.000/ 22.046
ATV930U30M3	IP20	28	1.1	1	VW3A7742	4.000/ 8.818
ATV930U55M3	IP20	16	2.2	1	VW3A7743	7.000/ 15.432
ATV930D11M3	IP20	10	3.4	1	VW3A7744	11.500/ 25.353
ATV930D18M3	IP23	5	6.9	1	VW3A7746	27.000/ 59.524
ATV930U07N4...U40N4 ATV950U07N4...U40N4 ATV950U07N4E...U40N4E	IP20	100	1.7	1	VW3A7750	5.500/ 12.125
ATV930U55N4...U75N4 ATV950U55N4...U75N4 ATV950U55N4E...U75N4E	IP20	60	3.4	1	VW3A7751	10.000/ 22.046
ATV930U40M3 ATV930D11N4...D15N4 ATV950D11N4...D15N4 ATV950D11N4E...D15N4E	IP23	28	5.1	1	VW3A7752	25.000/ 55.116
ATV930U75M3 ATV930D18N4...D30N4 ATV950D18N4...D30N4 ATV950D18N4E...D30N4E	IP23	16	14	1	VW3A7753	47.000/ 103.617
ATV930D37N4...D45N4 ATV950D37N4...D45N4 ATV950D37N4E...D45N4E	IP23	10	19	1	VW3A7754	67.000/ 147.710
ATV930D90N4 ATV950D90N4 ATV950D90N4E	IP23	10	19	2		
ATV930D15M3 ATV930D55N4 ATV950D55N4 ATV950D55N4E	IP23	8	25	1	VW3A7755	86.000/ 189.597
ATV930D22M3 ATV930D75N4 ATV950D75N4 ATV950D75N4E	IP23	5	32	1	VW3A7756	126.000/ 277.782
ATV930D30M3...D45M3 ATV930C11N4C...C16N4C	IP23	5	32	2		
ATV930C22N4 ATV930C25N4C	IP23	5	32	3		
ATV930C31N4C	IP23	5	32	4		
ATV930D55M3C...D75M3C	IP23	1.4	29	1	VW3A7757	114.000/ 251.327

(1) Load factor for resistors: The value of the average power that can be dissipated at 50 °C/122 °C from the resistor into the casing is determined for a load factor during braking that corresponds to the majority of normal applications:
 - Heavy duty: 54 s braking with a 1 Tn braking torque and 6 s braking with a 1.65 Tn braking torque for a 120 s cycle

PF151269A



VW3A7755

References for a severe braking cycle (hoisting applications) (continued)

For drives	Degree of protection of the resistor	Ohmic value at 20 °C/ 68 °F	Average power available at 50 °C/ 122 °F (1)	Quantity required per drive	Reference	Weight
		Ω	kW			kg/lb
Supply voltage: 500...690 V 50/ 60 Hz						
ATV930U22Y6	IP20	100	1.4	1	VW3A7750	5.000/ 11.023
ATV930U30Y6	IP20	100	1.4	1	VW3A7750	5.000/ 11.023
ATV930U40Y6	IP20	100	1.4	1	VW3A7750	5.000/ 11.023
ATV930U55Y6	IP20	60	2.9	1	VW3A7751	8.300/ 18.298
ATV930U75Y6	IP20	60	2.9	1	VW3A7751	8.300/ 18.298
ATV930D11Y6	IP23	28	5.1	1	VW3A7752	27.000/ 59.524
ATV930D15Y6	IP23	28	5.1	1	VW3A7752	27.000/ 59.524
ATV930D18Y6	IP23	16	14	1	VW3A7753	48.500/ 106.924
ATV930D22Y6	IP23	16	14	1	VW3A7753	48.500/ 106.924
ATV930D30Y6	IP23	16	14	1	VW3A7753	48.500/ 106.924
ATV930D37Y6	IP23	10	19	1	VW3A7754	71.000/ 156.528
ATV930D45Y6	IP23	10	19	1	VW3A7754	71.000/ 156.528
ATV930D55Y6	IP23	8	25	1	VW3A7755	87.500/ 192.904
ATV930D75Y6	IP23	5	32	1	VW3A7756	126.000/ 277.782
ATV930D90Y6	IP23	10	19	2	VW3A7754	71.000/ 156.528

(1) Load factor for resistors: The value of the average power that can be dissipated at 50 °C/122 °C from the resistor into the casing is determined for a load factor during braking that corresponds to the majority of normal applications:

- Heavy duty: 54 s braking with a 1 Tn braking torque and 6 s braking with a 1.65 Tn braking torque for a 120 s cycle

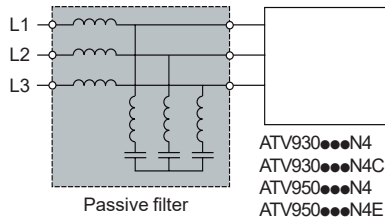

Altivar Process drive with passive filter

Presentation

Passive filters are used to obtain total harmonic distortion of less than 10% or 5%. Reactive power increases at no load or low load. To help reduce this reactive power, the filter capacitors can be disconnected (see the diagrams on our website www.schneider-electric.com). Passive filters provide IP 20 protection.

Applications

Reduction of current harmonics in order to use drives in the first environment (restricted distribution, domestic applications).

2



VW3A46106

Passive filters: 400 V 50 Hz three-phase supply

Motor rating	For Altivar Process drives	Filter Nominal current		Quantity required per drive	Reference (1)	Weight
		input	output			
kW	HP	A	A			kg/ lb
THDi < 10%						
0.75	1	ATV930U07N4 ATV950U07N4 ATV950U07N4E	6	6.2	1	VW3A46101 12.000/ 26.455
1.5	2	ATV930U15N4 ATV950U15N4 ATV950U15N4E				
2.2	3	ATV930U22N4 ATV950U22N4 ATV950U22N4E				
3	–	ATV930U30N4 ATV950U30N4 ATV950U30N4E				
4	5	ATV930U40N4 ATV950U40N4 ATV950U40N4E	10	10.4	1	VW3A46102 13.500/ 29.762
5.5	7.5	ATV930U55N4 ATV950U55N4 ATV950U55N4E				
7.5	10	ATV930U75N4 ATV950U75N4 ATV950U75N4E	14	14.5	1	VW3A46103 16.300/ 35.935
11	15	ATV930D11N4 ATV950D11N4 ATV950D11N4E	22	23	1	VW3A46104 22.000/ 48.502
15	20	ATV930D15N4 ATV950D15N4 ATV950D15N4E	29	30	1	VW3A46105 25.000/ 55.116
18.5	25	ATV930D18N4 ATV950D18N4 ATV950D18N4E	35	37	1	VW3A46106 37.000/ 81.571
22	30	ATV930D22N4 ATV950D22N4 ATV950D22N4E	43	45	1	VW3A46107 39.000/ 85.980
30	40	ATV930D30N4 ATV950D30N4 ATV950D30N4E	58	60	1	VW3A46108 44.000/ 97.003
37	50	ATV930D37N4 ATV950D37N4 ATV950D37N4E	72	75	1	VW3A46109 56.000/ 123.459
45	60	ATV930D45N4 ATV950D45N4 ATV950D45N4E	86	90	1	VW3A46110 62.000/ 136.686
55	75	ATV930D55N4 ATV930D55N4C ATV950D55N4 ATV950D55N4E	101	105	1	VW3A46111 74.000/ 163.142
75	100	ATV930D75N4 ATV930D75N4C ATV950D75N4 ATV950D75N4E	144	150	1	VW3A46112 85.000/ 187.393
90	125	ATV930D90N4 ATV930D90N4C ATV950D90N4 ATV950D90N4E	180	187	1	VW3A46113 102.000/ 224.871

(1) When used with ATV950U07N4/N4E...D90N4/N4E drives, the filter must be mounted in a separate enclosure to maintain IP 55 protection for the installation.



VW3A46116

Passive filters: 400 V 50 Hz three-phase supply

Motor rating		For Altivar Process drives	Filter		Quantity required per drive	Reference	Weight
kW	HP		Nominal current				
			input	output			kg/ lb
THDi < 10% (continued)							
110	150	ATV930C11N4C	217	225	1	VW3A46114	119.000/ 262.350
132	200	ATV930C13N4C	252	262	1	VW3A46115	136.000/ 299.828
160	250	ATV930C16N4C	304	316	1	VW3A46116	142.000/ 313.056
220	350	ATV930C22N4 ATV930C22N4C	380	395	1	VW3A46118	185.000/ 407.855
250	400	ATV930C25N4C	433	450	1	VW3A46119	203.000/ 447.538
315	500	ATV930C31N4C	304	316	2	VW3A46116	142.000/ 313.056

Variable speed drives

Altivar Process ATV900

Option: Passive filters



VW3A46126

2

Passive filters: 400 V 50 Hz three-phase supply							
Motor rating		For Altivar Process drives	Filter		Quantity required per drive	Reference (1)	Weight
kW	HP		Nominal current input	Nominal current output			
			A	A			kg/lb
THDi < 5%							
0.75	1	ATV930U07N4 ATV950U07N4 ATV950U07N4E	6	6.2	1	VW3A46120	16.000/ 35.274
1.5	2	ATV930U15N4 ATV950U15N4 ATV950U15N4E					
2.2	3	ATV930U22N4 ATV950U22N4 ATV950U22N4E					
3	–	ATV930U30N4 ATV950U30N4 ATV950U30N4E					
4	5	ATV930U40N4 ATV950U40N4 ATV950U40N4E	10	10.4	1	VW3A46121	18.000/ 39.683
5.5	7.5	ATV930U55N4 ATV950U55N4 ATV950U55N4E					
7.5	10	ATV930U75N4 ATV950U75N4 ATV950U75N4E	14	14.5	1	VW3A46122	20.000/ 44.092
11	15	ATV930D11N4 ATV950D11N4 ATV950D11N4E	22	23	1	VW3A46123	30.000/ 66.139
15	20	ATV930D15N4 ATV950D15N4 ATV950D15N4E	29	30	1	VW3A46124	34.000/ 74.957
18.5	25	ATV930D18N4 ATV950D18N4 ATV950D18N4E	35	37	1	VW3A46125	53.000/ 116.845
22	30	ATV930D22N4 ATV950D22N4 ATV950D22N4E	43	45	1	VW3A46126	58.000/ 127.868
30	40	ATV930D30N4 ATV950D30N4 ATV950D30N4E	58	60	1	VW3A46127	76.000/ 167.551
37	50	ATV930D37N4 ATV950D37N4 ATV950D37N4E	72	75	1	VW3A46128	98.000/ 216.053
45	60	ATV930D45N4 ATV950D45N4 ATV950D45N4E	86	90	1	VW3A46129	104.000/ 229.281
55	75	ATV930D55N4 ATV930D55N4C ATV950D55N4 ATV950D55N4E	101	105	1	VW3A46130	106.000/ 233.690
75	100	ATV930D75N4 ATV930D75N4C ATV950D75N4 ATV950D75N4E	144	150	1	VW3A46131	126.000/ 277.782
90	125	ATV930D90N4 ATV930D90N4C ATV950D90N4 ATV950D90N4E	180	187	1	VW3A46132	135.000/ 297.623

(1) When used with ATV950U07N4/N4E...D90N4/N4E drives, the filter must be mounted in a separate enclosure to maintain IP 55 protection for the installation.

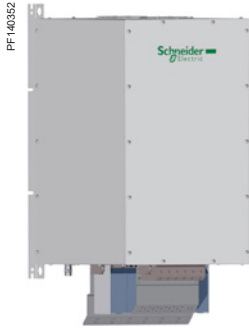

VW3A46135

Passive filters: 400 V 50 Hz three-phase supply							
Motor rating		For Altivar Process drives	Filter		Quantity required per drive	Reference	Weight
kW	HP		Nominal current input	Nominal current output			
			A	A			kg/ lb
THDi < 5% (continued)							
110	150	ATV930C11N4C	217	225	1	VW3A46133	172.000/ 379.195
132	200	ATV930C13N4C	252	262	1	VW3A46134	206.000/ 454.152
160	250	ATV930C16N4C	304	316	1	VW3A46135	221.000/ 487.221
220	350	ATV930C22N4 ATV930C22N4C	380	395	1	VW3A46137	265.000/ 584.225
250	400	ATV930C25N4C	433	450	1	VW3A46138	272.000/ 599.657
315	500	ATV930C31N4C	304	316	2	VW3A46135	221.000/ 487.222



Variable speed drives

Altivar Process ATV900

Option: Passive filters



VW3A46144

2

Passive filters: 460 V 60 Hz three-phase supply							
Motor rating	For Altivar Process drives	Filter	Nominal current		Quantity required per drive	Reference (1)	Weight
			input	output			
kW	HP		A	A			kg/lb
THDi < 10%							
0.75	1	ATV930U07N4 ATV950U07N4 ATV950U07N4E	6	6.2	1	VW3A46139	12.000/ 26.455
1.5	2	ATV930U15N4 ATV950U15N4 ATV950U15N4E					
2.2	3	ATV930U22N4 ATV950U22N4 ATV950U22N4E					
3	–	ATV930U30N4 ATV950U30N4 ATV950U30N4E					
4	5	ATV930U40N4 ATV950U40N4 ATV950U40N4E	10	10.4	1	VW3A46140	13.500/ 29.762
5.5	7.5	ATV930U55N4 ATV950U55N4 ATV950U55N4E					
7.5	10	ATV930U75N4 ATV950U75N4 ATV950U75N4E	14	14.5	1	VW3A46141	16.300/ 35.935
11	15	ATV930D11N4 ATV950D11N4 ATV950D11N4E	19	19.5	1	VW3A46142	22.000/ 48.502
15	20	ATV930D15N4 ATV950D15N4 ATV950D15N4E	25	26	1	VW3A46143	23.000/ 50.706
18.5	25	ATV930D18N4 ATV950D18N4 ATV950D18N4E	31	32	1	VW3A46144	33.000/ 72.752
22	30	ATV930D22N4 ATV950D22N4 ATV950D22N4E	36	37	1	VW3A46145	37.000/ 81.571
30	40	ATV930D30N4 ATV950D30N4 ATV950D30N4E	48	50	1	VW3A46146	39.000/ 85.980
37	50	ATV930D37N4 ATV950D37N4 ATV950D37N4E	60	62	1	VW3A46147	43.000/ 94.799
45	60	ATV930D45N4 ATV950D45N4 ATV950D45N4E	73	76	1	VW3A46148	55.000/ 121.254
55	75	ATV930D55N4 ATV930D55N4C ATV950D55N4 ATV950D55N4E	95	99	1	VW3A46149	62.000/ 136.686
75	100	ATV930D75N4 ATV930D75N4C ATV950D75N4 ATV950D75N4E	118	122	1	VW3A46150	74.000/ 163.142
90	125	ATV930D90N4 ATV930D90N4C ATV950D90N4 ATV950D90N4E	154	160	1	VW3A46151	85.000/ 187.393
110	150	ATV930C11N4C	183	190	1	VW3A46152	102.000/ 224.871
132	200	ATV930C13N4C	231	240	1	VW3A46153	119.000/ 262.350
160	250	ATV930C16N4C	291	302.5	1	VW3A46154	142.000/ 313.056
220	350	ATV930C22N4 ATV930C22N4C	355	369	1	VW3A46155	162.000/ 357.149
250	400	ATV930C25N4C	436	450	2	VW3A46157	205.000/ 451.948
315	500	ATV930C31N4C	231	240	2	VW3A46153	119.000/ 262.350

(1) When used with ATV950U07N4/N4E...D90N4/N4E drives, the filter must be mounted in a separate enclosure to maintain IP 55 protection for the installation.



VW3A46164

Passive filters: 460 V 60 Hz three-phase supply

Motor rating	For Altivar Process drives	Filter	Nominal current		Quantity required per drive	Reference (1)	Weight
			input	output			
kW	HP		A	A			kg/lb
THDi < 5%							
0.75	1	ATV930U07N4 ATV950U07N4 ATV950U07N4E	6	6.2	1	VW3A46158	16.000/ 35.274
1.5	2	ATV930U15N4 ATV950U15N4 ATV950U15N4E					
2.2	3	ATV930U22N4 ATV950U22N4 ATV950U22N4E					
3	–	ATV930U30N4 ATV950U30N4 ATV950U30N4E					
4	5	ATV930U40N4 ATV950U40N4 ATV950U40N4E	10	10.4	1	VW3A46159	18.000/ 39.683
5.5	7.5	ATV930U55N4 ATV950U55N4 ATV950U55N4E					
7.5	10	ATV930U75N4 ATV950U75N4 ATV950U75N4E	14	14.5	1	VW3A46160	20.000/ 44.092
11	15	ATV930D11N4 ATV950D11N4 ATV950D11N4E	19	19.5	1	VW3A46161	30.000/ 66.139
15	20	ATV930D15N4 ATV950D15N4 ATV950D15N4E	25	26	1	VW3A46162	34.000/ 74.957
18.5	25	ATV930D18N4 ATV950D18N4 ATV950D18N4E	31	32	1	VW3A46163	52.000/ 114.640
22	30	ATV930D22N4 ATV950D22N4 ATV950D22N4E	36	37	1	VW3A46164	53.000/ 116.845
30	40	ATV930D30N4 ATV950D30N4 ATV950D30N4E	48	50	1	VW3A46165	57.000/ 125.663
37	50	ATV930D37N4 ATV950D37N4 ATV950D37N4E	60	62	1	VW3A46166	75.000/ 165.347
45	60	ATV930D45N4 ATV950D45N4 ATV950D45N4E	73	76	1	VW3A46167	97.000/ 213.848
55	75	ATV930D55N4 ATV930D55N4C ATV950D55N4 ATV950D55N4E	95	99	1	VW3A46168	104.000/ 229.281
75	100	ATV930D75N4 ATV930D75N4C ATV950D75N4 ATV950D75N4E	118	122	1	VW3A46169	106.000/ 233.690
90	125	ATV930D90N4 ATV930D90N4C ATV950D90N4 ATV950D90N4E	154	160	1	VW3A46170	126.000/ 277.782
110	150	ATV930C11N4C	183	190	1	VW3A46171	135.000/ 297.624
132	200	ATV930C13N4C	231	240	1	VW3A46172	170.000/ 374.786
160	250	ATV930C16N4C	291	316	1	VW3A46173	221.000/ 487.221
220	350	ATV930C22N4 ATV930C22N4C	355	369	1	VW3A46174	229.000/ 504.859
250	400	ATV930C25N4C	436	450	1	VW3A46176	270.000/ 595.248
315	500	ATV930C31N4C	231	240	2	VW3A46172	170.000/ 374.786

(1) When used with ATV950U07N4/N4E...D90N4/N4E drives, the filter must be mounted in a separate enclosure to maintain IP 55 protection for the installation.

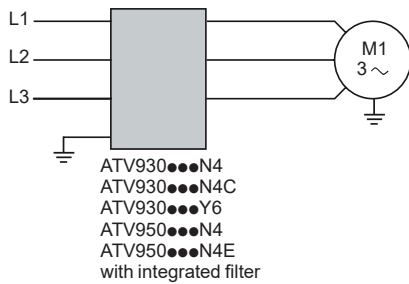

Altivar Process drive with integrated EMC filter

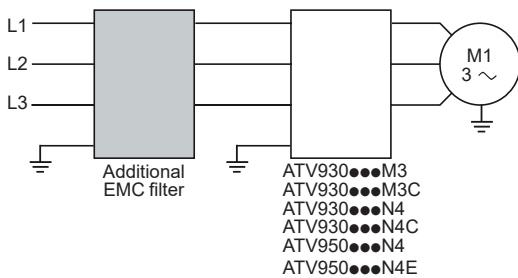

Altivar Process drive with additional EMC filter

Integrated EMC filters

Altivar Process drives (except ATV930●●●M3/M3C) have integrated radio interference input filters in accordance with the EMC standard for variable speed electrical power drive "products" IEC/EN 61800-3, edition 2, category C2 or C3 in environment 1 or 2, and to comply with the European EMC (electromagnetic compatibility) directive.

The integrated EMC filter runs off the leakage current to ground. The leakage current can be reduced by disconnecting the filter capacitors (please refer to the installation guide on our website www.schneider-electric.com). In this configuration, the product does not comply with the European EMC directive.

For drives	Maximum length of shielded cable (1) acc. to	
	IEC/EN 61800-3 category C2	IEC/EN 61800-3 category C3
	m	m
Three-phase supply voltage: 380...480 V		
ATV930U07N4...D45N4	50	150
ATV930D55N4/N4C...D90N4/N4C	–	150
ATV930C11N4C...C16N4C		
ATV930U07N4Z...D45N4Z	10	50
ATV930D55N4Z...D90N4Z	–	50
ATV930C22N4	–	50
ATV930C22N4C...C31N4C		
ATV930C11N4F...C31N4F	–	300
ATV950C11N4F...C31N4F		
Three-phase supply voltage: 380...480 V IP 55		
ATV950U07N4/N4E...D45N4/N4E	50	150
ATV950D55N4/N4E...D90N4/N4E	–	150
Three-phase supply voltage: 500...690 V IP 00		
ATV930U22Y6...D90Y6	–	25

Additional EMC input filters

Additional EMC input filters can be used to meet more stringent requirements and are designed to reduce conducted emissions on the line supply below the limits of standard IEC/EN 61800-3 category C1, C2 or C3.

Use according to the type of line supply

Use of these additional filters is only possible on TN (neutral connection) and TT (grounded neutral) type systems.

Standard IEC/EN 61800-3, appendix D2.1, states that on IT systems (isolated or impedance grounded neutral), filters can cause permanent insulation monitors to operate in a random manner.

If a machine needs to be installed on an IT system, one solution is to insert an isolation transformer and connect the machine locally to a TN or TT system.

References

For drives	Maximum length of shielded cable (1)			In (2)	If (2)	Reference	Weight
	IEC/EN 61800-3 category C1 (3)	IEC/EN 61800-3 category C2 (3)	IEC/EN 61800-3 category C3 (3)				
	m	m	m	A	mA		kg/lb
Three-phase supply voltage: 200...240 V 50 Hz							
ATV930U07M3...U15M3	50	150	300	8	7.6	VW3A4701	2.000/ 4.409
ATV930U22M3...U30M3	50	150	300	15	7.6	VW3A4702	2.400/ 5.291
ATV930U40M3...U75M3	50	150	300	35	7.6	VW3A4703	4.100/ 9.039
ATV930D11M3	50	150	300	50	7.6	VW3A4704	5.200/ 11.464
ATV930D15M3	50	150	300	70	13.9	VW3A4705	6.100/ 13.448
ATV930D18M3...D22M3	50	150	300	100	13.9	VW3A4706	6.500/ 14.330
ATV930D30M3...D37M3	50	150	300	160	13.9	VW3A4707	8.500/ 18.739
ATV930D30M3C...D37M3C							
ATV930D45M3	50	150	300	200	13.9	VW3A4708	9.500/ 20.944
ATV930D45M3C							
ATV930D55M3C	50	150	300	240	27.8	VW3A4709	15.000/ 33.069
ATV930D75M3C	50	150	300	305	27.8	VW3A4710	17.000/ 37.479

(1) The maximum lengths are given as examples only, as they vary depending on the stray capacitance of the motors and the cables used. If motors are connected in parallel, it is the total length of all cables that should be taken into account.

(2) Nominal filter current.

(3) Values given depend on the nominal switching frequency of the drive. This frequency depends on the drive rating.



VW3A4703



VW3A4411

Additional EMC input filters (continued)

References (continued)

For drives	Maximum length of shielded cable (1) (2)			In (4)	If	Reference (5)	Weight
	IEC/EN 61800-3 category C1 (3)	IEC/EN 61800-3 category C2 (3)	IEC/EN 61800-3 category C3 (3)				
	m	m	m				
Three-phase supply voltage: 380...480 V 50 Hz							
ATV930U07N4...U22N4(Z) ATV950U07N4...U22N4 ATV950U07N4E...U22N4E	50	150	300	8	7.6	VW3A4701	2.000/ 4.409
ATV930U30N4...U55N4(Z) ATV950U30N4...U55N4 ATV950U30N4E...U55N4E	50	150	300	15	7.6	VW3A4702	2.400/ 5.291
ATV930U75N4...D15N4(Z) ATV950U75N4...D15N4 ATV950U75N4E...D15N4E	50	150	300	35	7.6	VW3A4703	4.100/ 9.039
ATV930D18N4...D22N4(Z) ATV950D18N4...D22N4 ATV950D18N4E...D22N4E	50	150	300	50	7.6	VW3A4704	5.200/ 11.464
ATV930D30N4(Z) ATV950D30N4 ATV950D30N4E	50	150	300	70	13.9	VW3A4705	6.100/ 13.448
ATV930D37N4...D45N4(Z) ATV950D37N4...D45N4 ATV950D37N4E...D45N4E	50	150	300	100	13.9	VW3A4706	6.500/ 14.330
ATV930D55N4(Z) ATV930D55N4C ATV950D55N4 ATV950D55N4E	50	150	300	160	13.9	VW3A4707	8.500/ 18.739
ATV930D75N4...D90N4(Z) ATV930D75N4C...D90N4C ATV950D75N4...D90N4 ATV950D75N4E...D90N4E	50	150	300	200	13.9	VW3A4708	9.500/ 20.944
ATV930C11N4C ATV930C13N4C	–	150	300	240	27.8	VW3A4709	15.000/ 33.069
ATV930C16N4C	–	150	300	305	27.8	VW3A4710	17.000/ 37.479
ATV930C22N4 ATV930C22N4C...C31N4C	50	300	–	546	599	VW3A4411	25.000/ 55.116

IP 21 protection kit for IP 20 filters

Additional input filters provide IP 20 protection as standard. This kit can be used to provide IP 21 or UL type 1 protection.

Description	For filters	Reference	Weight kg/ lb
Mechanical kit including cover and cable clamps	VW3A4701	VW3A47901	0.200/ 0.441
	VW3A4702	VW3A47902	0.300/ 0.661
	VW3A4703	VW3A47903	0.400/ 0.882
	VW3A4704	VW3A47904	0.500/ 1.102
	VW3A4705	VW3A47905	0.900/ 1.984
	VW3A4706	VW3A47906	1.000/ 2.205
	VW3A4707	VW3A47907	1.500/ 3.307
	VW3A4708	VW3A47908	2.000/ 4.409

(1) The maximum lengths are given as examples only, as they vary depending on the stray capacitance of the motors and the cables used. If motors are connected in parallel, it is the total length of all cables that should be taken into account.

(2) The associations of EMC filters with **ATV900U07N4/N4E...D22N4/N4E**, **ATV930C22N4** and **ATV930C22N4C...C31N4C** drives are also compliant with the IEC/EN 61800-3 category C1 standard with a 50 m shielded cable length.

(3) Values given depend on the nominal switching frequency of the drive. This frequency depends on the drive rating.

(4) Nominal filter current.

(5) When used with **ATV950U07N4/N4E...D90N4/N4E** drives, the filter must be mounted in a separate enclosure to maintain IP 55 protection for the installation.

Variable speed drives

Altivar Process ATV900: reduction of current harmonics

Option: Substitution kits for ATV61/71, AC line chokes

2



VW3A93111

Substitution kits for ATV61/71

This kit is used to install an Altivar Process drive in the place of an Altivar 61 or Altivar 71 drive using the same fixing holes. It includes the mechanical adaptors required for mounting.

For drives	From ATV61/71	Kit	Kit reference	Weight kg/lb
ATV930U07N4Z...U22N4Z	S2	1	VW3A93111	–
	S3	2	VW3A93112	–
	S4	4	VW3A93113	–
ATV930U75N4Z, D11N4Z	S4	5	VW3A93114	–
	S5A	7	VW3A93115	–
ATV930D15N4Z...D22N4Z	S5B	9	VW3A93116	–
	S6	9	VW3A93116	–
ATV930D30N4Z...D45N4Z	S6	11	VW3A93117	–
	S7A	11	VW3A93117	–
	S8	13	VW3A93118	–
ATV930D55N4Z...D90N4Z	S8	14	VW3A93119	–
	S9	15	VW3A93120	–

Line chokes

A line choke can be used to reduce harmonic distortion of the current produced by the drive.

The choke values are defined for a voltage drop between phases of 3% and 5% of the nominal supply voltage. Values higher than this will cause loss of torque.

Line chokes allow ATV930U22Y6...D90Y6 drives to be used in applications requiring a harmonic level of THDi 48%.

Chokes must be installed upstream of the drive.

References

For drives	Line Supply Isc	Line chokes			Reference	Weight
		Inductance value	Nominal Current	Losses		
	kA	mH	A	W		kg/lb
Three-phase supply voltage: 500...690 V 50/60 Hz						
ATV930U22Y6...40Y6	22	10	4	45	VW3A4551	1.500/ 2.204
ATV930U55Y6...75Y6	22	4	10	65	VW3A4552	3.000/ 6.613
ATV930D11Y6...15Y6	22	2	16	75	VW3A4553	3.500/ 7.716
ATV930D18Y6...22Y6	22	1	30	90	VW3A4554	6.000/ 13.227
ATV930D30Y6...45Y6	22	0.5	60	94	VW3A4555	11.000/ 24.250
ATV930D55Y6...90Y6	22	0.3	100	260	VW3A4556	16.000/ 35.274

PF142110



VW3A4556

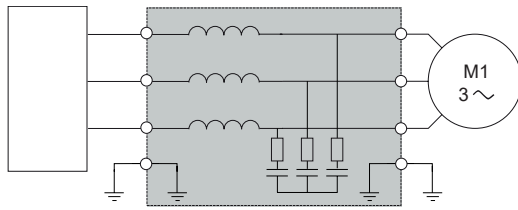

ATV930●●●M3
ATV930●●●M3C
ATV930●●●N4
ATV930●●●N4C
ATV950●●●N4
ATV950●●●N4E

dv/dt filter

Altivar Process drive with dv/dt filter

Presentation

Altivar Process drives with supply voltage of 200...240 V and 380...480 V operate with the following maximum motor cable lengths: 150 m/492 ft for shielded cables and 300 m/984 ft for unshielded cables.

For supply voltage of 500...690 V maximum motor cable lengths are: 10 m/32 ft for shielded cables and 20 m/65 ft for unshielded cables.

To limit the impact of dv/dt and overvoltages in the motor, it is advisable for cables longer than 50 m/164 ft, that an output filter is added if the motor insulation type does not conform to IEC60034-25.

For further information, please consult the An Improved Approach for Connecting VSD and Electric Motors White Paper available on our website www.schneider-electric.com.

Output filters are used to limit dv/dt at the motor terminals to 500 V/μs maximum for supply voltages up to 480 V, to 750 V/μs maximum for supply voltage of 500 V and to 1000 V/μs maximum for supply voltage of 690 V.

Output filters are designed to limit overvoltages at the motor terminals to less than:

- 800 V with a shielded cable 0 to 50 m (0 to 164 ft) long, with a 400 V supply voltage
- 1,000 V with a shielded cable 50 to 150 m (164 to 492 ft) long, with a 400 V supply voltage
- 1,500 V with a shielded cable 150 to 300 m (492 to 984 ft) long, with a 400 V supply voltage (up to 500 m (1,640 ft) with an unshielded cable)
- 1,300 V with 500 V supply voltage, cable length depending on the dv/dt filter combination
- 1,600 V with 690 V supply voltage, cable length depending on the dv/dt filter combination

The performance of dv/dt filters will be affected if the maximum cable lengths are exceeded. For an application with several motors connected in parallel, the cable length must include all cabling. If a cable longer than that specified is used, the dv/dt filters may overheat.

The switching frequency must be under 8 kHz.

dv/dt output filters

For drives	Maximum length of motor cable		Degree of protection	In (3)	Reference	Weight
	Maximum switching frequency (1)	Shielded cable (2)				
	kHz	m/ft	IP	A		kg/lb
Three-phase supply voltage: 200...240 V						
ATV930U07M3	4	300/ 984	20	6	VW3A5301	11.000/ 24.251
ATV930U15M3...U30M3	4	300/ 984	20	15	VW3A5302	12.000/ 26.455
ATV930U40M3	4	300/ 984	20	25	VW3A5303	12.000/ 26.455
ATV930U55M3...D11M3	4	300/ 984	20	50	VW3A5304	18.000/ 39.683
ATV930D15M3...D22M3	4	300/ 984	20	95	VW3A5305	19.000/ 41.888
ATV930D30M3...D45M3	2.5	300/ 984	00	180	VW3A5306	22.000/ 48.502
ATV930D30M3C...D45M3C						
ATV930D55M3C...D75M3C	2.5	300/ 984	00	305	VW3A5307	40.000/ 88.185

(1) The filters are designed to operate in a switching frequency range of between 2 and 8 kHz.

(2) Values given depend on the nominal switching frequency of the drive. This frequency depends on the drive rating. These cable lengths are given as examples only as they can vary depending on the application. They correspond to motors conforming to IEC 6034-25 and NEMA MG1/31.2006.

(3) Nominal filter current.

Variable speed drives

Altivar Process ATV900: Output filters

Option: dv/dt filters

2

PF14036EA



VW3A5304

dv/dt output filters (continued)

For drives	Maximum length of motor cable		Degree of protection (3)	In (4)	Reference (4)	Weight
	Maximum switching frequency (1)	Shielded cable frequency (2)				
	kHz	m/ft	IP	A		kg/lb
Three-phase supply voltage: 380...480 V						
ATV930U07N4...U22N4 ATV950U07N4...U22N4 ATV950U07N4E...U22N4E	4	300/ 984	20	6	VW3A5301	11.000/ 24.251
ATV930U30N4...U55N4 ATV950U30N4...U55N4 ATV950U30N4E...U55N4E	4	300/ 984	20	15	VW3A5302	12.000/ 26.455
ATV930U75N4...D11N4 ATV950U75N4...D11N4 ATV950U75N4E...D11N4E	4	300/ 984	20	25	VW3A5303	12.000/ 26.455
ATV930D15N4...D22N4 ATV950D15N4...D22N4 ATV950D15N4E...D22N4E	4	300/ 984	20	50	VW3A5304	18.000/ 39.683
ATV930D30N4...D45N4 ATV950D30N4...D45N4 ATV950D30N4E...D45N4E	4	300/ 984	20	95	VW3A5305	19.000/ 41.888
ATV930D55N4...D90N4 ATV930D55N4C...D90N4C ATV950D55N4...D90N4 ATV950D55N4E...D90N4E	2.5	300/ 984	00	180	VW3A5306	22.000/ 48.502
ATV930C11N4C...C16N4C	2.5	300/ 984	00	305	VW3A5307	40.000/ 88.185
ATV930C22N4 ATV930C22N4C	2.5	250/ 820	00	481	VW3A5106	58.000/ 127.868
ATV930C25N4C...C31N4C	2.5	200/ 656	00	759	VW3A5107	93.000/ 205.030
Three-phase supply voltage: 500...690 V						
ATV930U22Y6...U55Y6	6	50/ 164	00	90	VW3A5103	10.000/ 22.046
ATV930U75Y6, ATV930D11Y6	6	50/ 164	00	90	VW3A5103	10.000/ 22.046
	6	100/ 328	00	215	VW3A5104	15.500/ 34.171
ATV930D15Y6...30Y6	2.5	50/ 164	00	90	VW3A5103	10.000/ 22.046
	2.5	70/ 230	00	90	2 x VW3A5103	20.000/ 44.001
	4	35/ 213	00	90		
	4	150/ 492	00	215	VW3A5104	15.500/ 34.171
	6	100/ 328	00	215		
	6	150/ 492	00	215	2 x VW3A5104	31.000/ 68.342
ATV930D37Y6...D90Y6	4	100/ 328	00	215	VW3A5104	15.500/ 34.171
	4	150/ 492	00	215	2 x VW3A5104	31.000/ 68.342

(1) The filters are designed to operate in a switching frequency range of between 2 and 8 kHz.

(2) Values given depend on the nominal switching frequency of the drive. This frequency depends on the drive rating. These cable lengths are given as examples only as they can vary depending on the application. They correspond to motors conforming to IEC 6034-25 and NEMA MG1/31.2006.

(3) Nominal filter current.

(4) When used with ATV950U07N4/N4E...D90N4/N4E drives, the filter must be mounted in a separate enclosure to maintain IP 55 protection for the installation.

PF152807

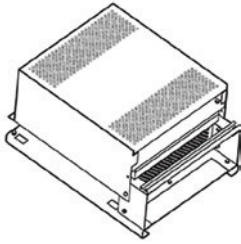

VW3A9612

IP 20 protection kit for IP 00 filters

Description	For dv/dt filters	Reference	Weight kg/lb
Mechanical kit including cover and cable clamps	VW3A5104	VW3A9612	–
	VW3A5106 VW3A5107	VW3A9613	–

IP 21 protection kit for IP 20 filters

Description	For dv/dt filters	Reference	Weight kg/lb
Mechanical kit including cover and cable clamps	VW3A5301 VW3A5302 VW3A5303	VW3A53902	1.300/ 2.866
	VW3A5304	VW3A53903	1.700/ 3.748
	VW3A5305	VW3A53905	3.200/ 7.055

IP 30 protection kit for IP 00 filters

Additional input filters provide IP 00 protection as standard. This kit can be used to provide IP 30 protection.

Description	For filters	Reference	Weight kg/lb
Mechanical device consisting of an IP 30 cover and cable clips	VW3A4410, 411	VW3A9601	–
	VW3A4412, 413	VW3A9602	–



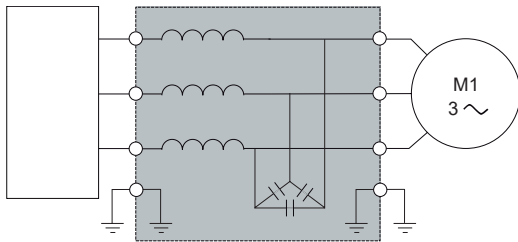

ATV930●●●M3
ATV930●●●M3C
ATV930●●●N4
ATV930●●●N4C
ATV930●●●Y6
ATV950●●●N4
ATV950●●●N4E

Sinus filter

Altivar Process drive with sinus filter

Presentation

Sinus filters allow Altivar Process drives to operate with long motor cables:

- 500 m (1,640 ft) with a shielded cable
- 1,000 m (3,280 ft) with an unshielded cable

The minimum switching frequency at which sinus filters can operate is 4 kHz. This is the default value when the sinus filter function is activated on the variable speed drive (please refer to the programming guide on our website www.schneider-electric.com).

The output frequency must be less than 100 Hz.

At 100% load, the voltage drop is less than 8% with output frequency 50 Hz and switching frequency 2 kHz.

Applications

For applications requiring:

- Long cable runs
- Motors connected in parallel
- Submersible pumps sensitive to dv/dt
- An intermediate transformer between the drive and the motor

Sinus filters

For drives	Nominal current A	Degree of protection IP	Reference (1)	Weight kg/ lb
Three-phase supply voltage: 200...240 V				
ATV930U07M3	6	20	VW3A5401	10.000/ 22.046
ATV930U15M3...U30M3	15	20	VW3A5402	13.500/ 29.762
ATV930U40M3	25	20	VW3A5403	20.000/ 44.092
ATV930U55M3...D11M3	50	20	VW3A5404	35.000/ 77.162
ATV930D15M3...D22M3	95	20	VW3A5405	60.000/ 132.277
ATV930D30M3...D45M3 ATV930D30M3C...D45M3C	180	00	VW3A5406	90.000/ 198.416
ATV930D75M3C (2)	305	00	VW3A5407	134.000/ 295.419

(1) The filters are designed to operate in a switching frequency range of between 4 and 8 kHz.

(2) In "Normal duty", apply a derating of Pn-1 to the drive nominal power with a minimum switching frequency of 4 kHz.

For example: An ATV930D75M3C drive with sinus filter can be used on a 55 kW motor.

Variable speed drives

Altivar Process ATV900: Output filters

Option: Sinus filters

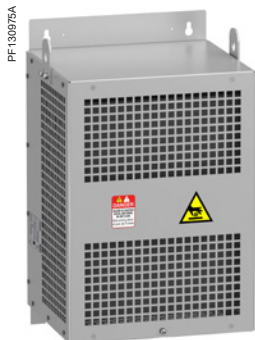

VW3A5404

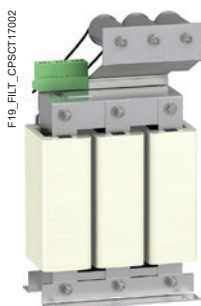

VW3A5216

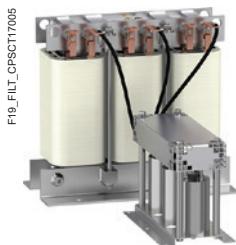

VW3A5219

Sinus filters (continued)

For drives	Maximum length of unshielded motor cable	Nominal current	Degree of protection	Reference (1) (2)	Weight
Three-phase supply voltage: 380...480 V					
ATV930U07N4...U22N4 ATV950U07N4...U22N4 ATV950U07N4E...U22N4E	1000/ 3.280	6	20	VW3A5401	10.000/ 22.046
ATV930U30N4...U55N4 ATV950U30N4...U55N4 ATV950U30N4E...U55N4E	1000/ 3.280	15	20	VW3A5402	13.500/ 29.762
ATV930U75N4...D11N4 ATV950U75N4...D11N4 ATV950U75N4E...D11N4E	1000/ 3.280	25	20	VW3A5403	20.000/ 44.092
ATV930D15N4...D22N4 ATV950D15N4...D22N4 ATV950D15N4E...D22N4E	1000/ 3.280	50	20	VW3A5404	35.000/ 77.162
ATV930D30N4...D45N4 ATV950D30N4...D45N4 ATV950D30N4E...D45N4E	1000/ 3.280	95	20	VW3A5405	60.000/ 132.277
ATV930D55N4...D90N4 ATV930D55N4C...D90N4C ATV950D55N4...D90N4 ATV950D55N4E...D90N4E	1000/ 3.280	180	00	VW3A5406	90.000/ 198.416
ATV930C13N4C...C16N4C (3)	1000/ 3.280	305	00	VW3A5407	134.000/ 295.419
ATV930C22N4 (3) ATV930C22N4C (3)	400/ 1.312	400	00	VW3A5209	190.000/ 418.878
ATV930C25N4C...C31N4C (3)	400/ 1.312	600	00	VW3A5210	260.000/ 573.202
Three-phase supply voltage: 500...690 V					
ATV930U22Y6...U75Y6	500/ 1.640	13	20	VW3A5215	13.500/ 29.762
ATV930D11Y6...D22Y6	500/ 1.640	28	20	VW3A5216	25.400/ 55.997
ATV930D30Y6...D37Y6	500/ 1.640	45	20	VW3A5217	38.000/ 83.776
ATV930D45Y6...D55Y6	750/ 2.460	75	20	VW3A5218	75.000/ 165.347
ATV930D75Y6...D90Y6	750/ 2.460	115	20	VW3A5219	106.000/ 233.690

IP 21 protection kit for IP 20 filters

Description	For sinus filter	Reference	Weight kg/ lb
Mechanical kit including cover and cable clamps	VW3A5401	VW3A53901	1.000/ 2.205
	VW3A5402	VW3A53902	1.300/ 2.866
	VW3A5403	VW3A53903	2.700/ 5.952
	VW3A5404	VW3A53904	3.200/ 7.055

(1) The filters are designed to operate in a switching frequency range of between 4 and 8 kHz.

(2) When used with ATV950U07N4/N4E...D90N4/N4E drives, the filter must be mounted in a separate enclosure to maintain IP 55 protection for the installation.

(3) In "Normal Duty", apply a derating of Pn-1 to the drive nominal power with a minimum switching frequency of 4 kHz. For example:

An ATV930C13N4C drive with sinus filter can be used on a 110 kW motor.

An ATV930C16N4C drive with sinus filter can be used on a 132 kW motor.

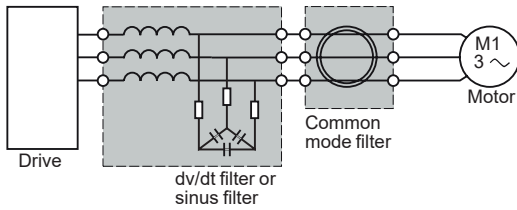

Altivar Process ATV900 drive with common mode filter

Presentation

Sinus filters or dv/dt filters reduce the overvoltage across windings and high frequency currents in differential mode. But they have no effect on the common mode current between phases and the cable shielding, and between the windings and the stator/rotor of the motor.

Common mode filters bring several benefits:

- Reduction of RFI (Radio Frequency Interference) of the motor cable and improvement of the effectiveness of the EMC filter for conducted emissions
- Reduction of the high frequency currents circulating in the bearings of the motor and prevention of their damage.

It is possible to use the common mode filter at the output terminals of the drive, the dv/dt filter, or the sinus filter.

Note: The selection of a common mode configuration depends on the type and length of motor cable. An abnormal increase of the temperature indicates a possible saturation. Additional filters shall be used to avoid it.

Common mode filters

For drives	Maximum length of unshielded cable			
	150 m/ 492.12 ft	300 m/ 984.25 ft	500 m/ 1,640.42 ft	1,000 m/ 3,280.83 ft
ATV930U07M3...U40M3	VW3A5501	VW3A5502	2 x VW3A5501	VW3A5501 + VW3A5502
ATV930U55M3	VW3A5501	VW3A5502	VW3A5501 + VW3A5502	2 x VW3A5502
ATV930U75M3...D11M3	VW3A5503	VW3A5504	2 x VW3A5503	VW3A5503 + VW3A5504
ATV930D15M3...D22M3	VW3A5503	VW3A5504	VW3A5503 + VW3A5504	2 x VW3A5504
ATV930D30M3...D45M3 ATV930D30M3C...D45M3C	VW3A5503	VW3A5504	VW3A5503 + VW3A5504	2 x VW3A5504
ATV930D55M3C...D75M3C	VW3A5505	VW3A5506	VW3A5505 + VW3A5506	VW3A5506

PF130952A

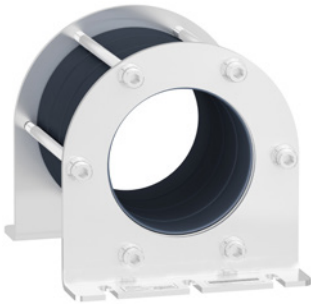

VW3A5503

Common mode filters (continued)

For drives	Maximum length of unshielded cable			
	150 m/ 492.12 ft	300 m/ 984.25 ft	500 m/ 1,640.42 ft	1,000 m/ 3,280.83 ft
ATV930U07N4...U40N4 ATV950U07N4...U40N4 ATV950U07N4E...U40N4E	VW3A5501	VW3A5502	2 x VW3A5501	VW3A5501 + VW3A5502
ATV930U55N4 ATV950U55N4 ATV950U55N4E	VW3A5501	VW3A5502	VW3A5501 + VW3A5502	VW3A5501 + VW3A5502
ATV930U75N4...D11N4 ATV950U75N4...D11N4 ATV950U75N4E...D11N4E	VW3A5501	VW3A5502	VW3A5501 + VW3A5502	2 x VW3A5502
ATV930D15N4...D22N4 ATV950D15N4...D22N4 ATV950D15N4E...D22N4E	VW3A5503	VW3A5504	2 x VW3A5503	VW3A5503 + VW3A5504
ATV930D30N4...D90N4 ATV930D55N4C...D90N4C ATV950D30N4...D90N4 ATV950D30N4E...D90N4E	VW3A5503	VW3A5504	VW3A5503 + VW3A5504	2 x VW3A5504
ATV930C11N4C...C16N4C	VW3A5505	VW3A5506	2 x VW3A5505	2 x VW3A5506

For drives	Maximum length of shielded cable		
	150 m/ 492.12 ft	300 m/ 984.25 ft	500 m/ 1,640.42 ft
ATV930U07N4...U40N4 ATV950U07N4...U40N4 ATV950U07N4E...U40N4E	VW3A5501	VW3A5502	2 x VW3A5501
ATV930U55N4 ATV950U55N4 ATV950U55N4E	VW3A5502	2 x VW3A5501	2 x VW3A5502
ATV930U75N4...D11N4 ATV950U75N4...D11N4 ATV950U75N4E...D11N4E	VW3A5502	2 x VW3A5501	2 x VW3A5502
ATV930D15N4...D22N4 ATV950D15N4...D22N4 ATV950D15N4E...D22N4E	VW3A5503	2 x VW3A5503	VW3A5503 + VW3A5504
ATV930D30N4...D90N4 ATV930D55N4C...D90N4C ATV950D30N4...D90N4 ATV950D30N4E...D90N4E	VW3A5504	VW3A5503 + VW3A5504	2 x VW3A5504
ATV930C11N4C	VW3A5505	VW3A5506	VW3A5505 + VW3A5506
ATV930C13N4C...C16N4C	VW3A5506	2 x VW3A5505	2 x VW3A5506

Applications

Circuit breaker/contactors/drive combinations help to ensure continuity of service in the installation.

The type of circuit breaker/contactors coordination selected can reduce maintenance costs in the event of a short-circuit on the drive input by minimizing the time required to make the necessary repairs and the cost of replacement equipment. The suggested combinations provide coordination according to the drive rating.

The drive controls the motor, provides a monitoring function against short-circuits between the drive and the motor, and helps protect the motor cable against overloads. Overload monitoring is provided by the drive's motor thermal monitoring function if this has been enabled. Otherwise, an external monitoring device such as a probe or thermal overload relay must be provided.

Selecting Short Circuit Protection Devices (fuses or circuit breakers) is key to protect the overall installation against potential damages due to short circuits. It is recommended to refer to the installation/integration manual of the Power Drive System (PDS) for more information.

IEC standard motor starters

Motor Power (1)	Drive Reference	Circuit breaker Reference (2)	Rating	I _{rm}	Line contactor Reference (3) (4)
kW HP			A	A	
Three-phase supply voltage: 200...240 V 50/60 Hz					
0.75 1	ATV930U07M3	GV2L08	4	51	LC1D09●●
1.5 2	ATV930U15M3	GV2L10	6.3	78	LC1D09●●
2.2 3	ATV930U22M3	GV2L14	10	138	LC1D09●●
3 -	ATV930U30M3	GV2L16	14	170	LC1D18●●
4 5	ATV930U40M3	GV2L20	18	223	LC1D18●●
5.5 7.5	ATV930U55M3	GV2L22	25	327	LC1D25●●
7.5 10	ATV930U75M3	GV2L32	32	448	LC1D40A●●
11 15	ATV930D11M3	GV3L40	40	560	LC1D40A●●
15 20	ATV930D15M3	GV3L65	65	910	LC1D65A●●
18.5 25	ATV930D18M3	GV4L/LE80●	80	480	LC1D65A●●
22 30	ATV930D22M3	GV4L/LE80●	80	480	LC1D80●●
30 40	ATV930D30M3	GV4L/LE115●	100	600	LC1D95●●
30 40	ATV930D30M3C	GV4L/LE115●	100	600	LC1D95●●
37 50	ATV930D37M3	NSX160●MA150	150	1,350	LC1D115●●
37 50	ATV930D37M3C	NSX160●MA150	150	1,350	LC1D115●●
45 60	ATV930D45M3	NSX160●MA150	150	1,350	LC1D150●●
45 60	ATV930D45M3C	NSX160●MA150	150	1,350	LC1D150●●
55 75	ATV930D55M3C	NSX250●MA220	220	1,980	LC1F185●●
75 100	ATV930D75M3C	NSX400● Micrologic 1.3-M	320	1,600	LC1F265●●

(1) Standard power ratings for 230 V 50/60 Hz 4-pole motors.

The values expressed in HP conform to the NEC (National Electrical Code).

(2) For references to be completed, replace the dot with the letter corresponding to the breaking performance of the circuit breaker (F, N, H, S or L).

Breaking capacity of circuit breakers according to standard IEC 60947-2:

Circuit breaker	I _{cu} (kA) for 200...240 V	I _{cu} (kA) for 200...240 V					
		B	F	N	H	S	L
GV2L08...L20	>100	-	-	-	-	-	-
GV2L22...L32	50	-	-	-	-	-	-
GV3L40...L65	100	-	-	-	-	-	-
GV4L80/115●	-	50	-	100	-	-	-
GV4LE80/115●	-	50	-	100	-	120	-
NSX160●MA150	-	-	85	90	100	120	150
NSX250●MA220	-	-	85	90	100	120	150
NSX400● Micrologic 1.3-M	-	-	40	85	100	120	150

(3) Composition of contactors:

LC1D09...D150: 3 poles + 1 NO auxiliary contact + 1 NC auxiliary contact

LC1F185...F265: 3 poles

To add auxiliary contacts or other accessories, please refer to the "Motor-starter solutions - Control and protection components" catalog.

(4) Replace ●● with the control circuit voltage code indicated in the table below:

	Volts ~	24	48	110	220	230	240
LC1D09...D150	50 Hz	B5	E5	F5	M5	P5	U5
	60 Hz	B6	E6	F6	M6	-	U6
	50/60 Hz	B7	E7	F7	M7	P7	U7
LC1F185	50 Hz (LX1 coil)	B5	E5	F5	M5	P5	U5
	60 Hz (LX1 coil)	-	E6	F6	M6	-	U6
	40...400 Hz (LX9 coil)	-	E7	F7	M7	P7	U7
LC1F265	40...400 Hz (LX1 coil)	B7	E7	F7	M7	P7	U7

For other voltages available between 24 V and 660 V, or a DC control circuit, please contact our Customer Care Center.



GV3L40

+



LC1D40A●●

+



ATV930D11M3



+



+



IEC standard motor starters						
Motor	Drive	Circuit breaker			Line contactor	
Power (1)	Reference	Reference (2)	Rating	I _{rm}	Reference (3) (4)	
kW	HP		A	A		
Three-phase supply voltage: 380...415 V 50/60 Hz						
0.75	1	ATV930U07N4	GV2L07	2.5	33.5	LC1D09●●
1.5	2	ATV930U15N4	GV2L08	4	51	LC1D09●●
2.2	3	ATV930U22N4	GV2L10	6.3	78	LC1D09●●
3	–	ATV930U30N4	GV2L14	10	138	LC1D09●●
4	5	ATV930U40N4	GV2L14	10	138	LC1D09●●
5.5	7.5	ATV930U55N4	GV2L16	14	170	LC1D18●●
7.5	10	ATV930U75N4	GV2L20	18	223	LC1D18●●
11	15	ATV930D11N4	GV2L22	25	327	LC1D25●●
15	20	ATV930D15N4	GV3L32	32	448	LC1D25●●
18.5	25	ATV930D18N4	GV3L40	40	560	LC1D40A●●
22	30	ATV930D22N4	GV3L50	50	700	LC1D50A●●
30	40	ATV930D30N4	GV3L65	65	910	LC1D50A●●
37	50	ATV930D37N4	GV4L/LE80●	80	480	LC1D65A●●
45	60	ATV930D45N4	GV4L/LE115●	115	690	LC1D80●●
55	75	ATV930D55N4	GV4L/LE115●	115	690	LC1D80●●
55	75	ATV930D55N4C	GV4L/LE115●	150	690	LC1D115●●
75	100	ATV930D75N4	NSX160●MA150	150	1,350	LC1D115●●
75	100	ATV930D75N4C	NSX160●MA150	150	1,350	LC1D115●●
90	125	ATV930D90N4	NSX250●MA220	220	1,980	LC1F185●●
90	125	ATV930D90N4C	NSX250●MA220	220	1,980	LC1F185●●
110	150	ATV930C11N4C	NSX250●MA220	220	1,980	LC1F185●●
132	200	ATV930C13N4C	NSX400● Micrologic 1.3-M	320	1,600	LC1F265●●
160	250	ATV930C16N4C	NSX400● Micrologic 1.3-M	320	1,600	LC1F265●●
220	350	ATV930C22N4	NSX630● Micrologic 1.3-M	500	3,000	LC1F400●●
220	350	ATV930C22N4C	NSX630● Micrologic 1.3-M	500	3,000	LC1F400●●
250	400	ATV930C25N4C	NSX630● Micrologic 1.3-M	500	3,000	LC1F500●●
315	500	ATV930C31N4C	NS800L Micrologic 2 or 5	800	1,600	LC1F630●●

(1) Standard power ratings for 400 V 50/60 Hz 4-pole motors.

The values expressed in HP conform to the NEC (National Electrical Code).

(2) For references to be completed, replace the dot with the letter corresponding to the breaking performance of the circuit breaker (F, N, H, S or L). Breaking capacity of circuit breakers according to standard IEC 60947-2:

Circuit breaker	Icu (kA) for 380...415 V					
	B	F	N	H	S	L
GV2L07...L14	100	–	–	–	–	–
GV2L16...L22	50	–	–	–	–	–
GV3L32...L65	50	–	–	–	–	–
GV4L80/115●	–	25	–	50	–	–
GV4LE80/115●	–	25	–	50	100	–
NSX160●MA150	–	–	36	50	70	150
NSX250●MA220	–	–	36	50	70	150
NSX400●, NSX630●	–	–	36	50	70	150
NS800L Micrologic 2 or 5	–	–	–	–	–	150

(3) Composition of contactors:

LC1D09...D115: 3 poles + 1 NO auxiliary contact + 1 NC auxiliary contact

LC1F185...F265: 3 poles

To add auxiliary contacts or other accessories, please refer to the "Motor-starter solutions - Control and protection components" catalog.

(4) Replace ●● with the control circuit voltage code indicated in the table below:

	Volts ~	24	48	110	220	230	240
		LC1D09...D115	50 Hz	B5	E5	F5	M5
	60 Hz	B6	E6	F6	M6	–	U6
	50/60 Hz	B7	E7	F7	M7	P7	U7
LC1F185	50 Hz (LX1 coil)	B5	E5	F5	M5	P5	U5
	60 Hz (LX1 coil)	–	E6	F6	M6	–	U6
	40...400 Hz (LX9 coil)	–	E7	F7	M7	P7	U7
LC1F265	40...400 Hz (LX1 coil)	B7	E7	F7	M7	P7	U7
LC1F400...F800	40...400 Hz (LX1 coil)	–	E7	F7	M7	P7	U7

For other voltages available between 24 V and 660 V, or a DC control circuit, please contact our [Customer Care Center](#).



+



+



ATV950D45N4

2

IEC standard motor starters

Motor Power (1)	Drive Reference	Circuit breaker Reference (2)	Rating A	I _{rm} A	Line contactor Reference (3) (4) (5)
Three-phase supply voltage: 380...415 V 50/60 Hz					
0.75	1	ATV950U07N4/N4E	2.5	33.5	LC1D09●●
1.5	2	ATV950U15N4/N4E	4	51	LC1D09●●
2.2	3	ATV950U22N4/N4E	6.3	78	LC1D09●●
3	–	ATV950U30N4/N4E	10	138	LC1D09●●
4	5	ATV950U40N4/N4E	10	138	LC1D09●●
5.5	7.5	ATV950U55N4/N4E	14	170	LC1D18●●
7.5	10	ATV950U75N4/N4E	18	223	LC1D18●●
11	15	ATV950D11N4/N4E	25	327	LC1D25●●
15	20	ATV950D15N4/N4E	32	448	LC1D25●●
18.5	25	ATV950D18N4/N4E	40	560	LC1D40A●●
22	30	ATV950D22N4/N4E	50	700	LC1D50A●●
30	40	ATV950D30N4/N4E	65	910	LC1D50A●●
37	50	ATV950D37N4/N4E	80	480	LC1D65A●●
45	60	ATV950D45N4/N4E	115	690	LC1D80●●
55	75	ATV950D55N4/N4E	115	690	LC1D80●●
75	100	ATV950D75N4/N4E	150	1,350	LC1D115●●
90	125	ATV950D90N4/N4E	220	1,980	LC1F185●●

(1) Standard power ratings for 400 V 50/60 Hz 4-pole motors. The values expressed in HP conform to the NEC (National Electrical Code).
 (2) For references to be completed, replace the dot with the letter corresponding to the breaking performance of the circuit breaker (F, N, H, S or L).
 Breaking capacity of circuit breakers according to standard IEC 60947-2:

Circuit breaker	I _{cu} (kA) for 380...415 V						
	B	F	N	H	S	L	
GV2L07...L14	100	–	–	–	–	–	
GV2L16...L22	50	–	–	–	–	–	
GV3L32...L65	50	–	–	–	–	–	
GV4L80/115●	–	25	–	50	–	–	
GV4LE80/115●	–	25	–	50	100	–	
NSX160●MA150	–	–	36	50	70	150	
NSX250●MA220	–	–	36	50	70	150	

(3) Composition of contactors:
 LC1D09...D115: 3 poles + 1 NO auxiliary contact + 1 NC auxiliary contact
 LC1F185: 3 poles
 To add auxiliary contacts or other accessories, please refer to the "Motor-starter solutions - Control and protection components" catalog.

(4) Replace ●● with the control circuit voltage code indicated in the table below:

	Volts ~	24	48	110	220	230	240
		LC1D09...D115	50 Hz	B5	E5	F5	M5
	60 Hz	B6	E6	F6	M6	–	U6
	50/60 Hz	B7	E7	F7	M7	P7	U7
LC1F185	50 Hz (LX1 coil)	B5	E5	F5	M5	P5	U5
	60 Hz (LX1 coil)	–	E6	F6	M6	–	U6
	40...400 Hz (LX9 coil)	–	E7	F7	M7	P7	U7

For other voltages available between 24 V and 660 V, or a DC control circuit, please contact our [Customer Care Center](#).

(5) When used with ATV950U07N4/N4E...D90N4/N4E drives, the motor starters must be installed in a separate enclosure to maintain IP 55 protection for the installation.



GV2L08

+



LC1D09●●

+



ATV930U15N4

IEC standard motor starters

Motor Power (1)	Drive Reference	Circuit breaker Reference (2)	Rating A	I _{rm} A	Line contactor Reference (3) (4)	
Three-phase supply voltage: 440 V 50/60 Hz						
0.75	1	ATV930U07N4	GV2L07	2.5	33.5	LC1D09●●
1.5	2	ATV930U15N4	GV2L08	4	51	LC1D09●●
2.2	3	ATV930U22N4	GV2L10	6.3	78	LC1D09●●
3	–	ATV930U30N4	GV2L10	6.3	78	LC1D09●●
4	5	ATV930U40N4	GV2L14	10	138	LC1D09●●
5.5	7.5	ATV930U55N4	GV2L16	14	170	LC1D18●●
7.5	10	ATV930U75N4	GV2L16	14	170	LC1D18●●
11	15	ATV930D11N4	GV2L22	25	327	LC1D25●●
15	20	ATV930D15N4	GV3L32	32	448	LC1D25●●
18.5	25	ATV930D18N4	GV3L40	40	560	LC1D40A●●
22	30	ATV930D22N4	GV3L50	50	700	LC1D50A●●
30	40	ATV930D30N4	GV3L65	65	910	LC1D50A●●
37	50	ATV930D37N4	GV3L65	65	910	LC1D65A●●
45	60	ATV930D45N4	GV4L/LE80●	80	480	LC1D65A●●
55	75	ATV930D55N4C	GV4L/LE115●	115	690	LC1D80●●
75	100	ATV930D75N4C	NSX160●MA150	150	1,350	LC1D115●●
90	125	ATV930D90N4C	NSX250●MA220	220	1,980	LC1D115●●
110	150	ATV930C11N4C	NSX250●MA220	220	1,980	LC1F185●●
132	200	ATV930C13N4C	NSX250●MA220	220	1,980	LC1F185●●
160	250	ATV930C16N4C	NSX400● Micrologic 1.3-M	320	1,600	LC1F265●●
220	350	ATV930C22N4	NSX630● Micrologic 1.3-M	500	3,000	LC1F400●●
220	350	ATV930C22N4C	NSX630● Micrologic 1.3-M	500	3,000	LC1F400●●
250	400	ATV930C25N4C	NSX630● Micrologic 1.3-M	500	3,000	LC1F500●●
315	500	ATV930C31N4C	NS800L Micrologic 2 or 5	800	1,600	LC1F630●●

(1) Standard power ratings for 400 V 50/60 Hz 4-pole motors.

The values expressed in HP conform to the NEC (National Electrical Code).

(2) For references to be completed, replace the dot with the letter corresponding to the breaking performance of the circuit breaker (F, N, H, S or L).

Breaking capacity of circuit breakers according to standard IEC 60947-2:

Circuit breaker	I _{cu} (kA) for 440 V						
	B	F	N	H	S	L	
GV2L07...L10	>100	–	–	–	–	–	
GV2L14...L22	50	–	–	–	–	–	
GV3L32...L65	50	–	–	–	–	–	
GV4L80/115●	–	25	–	50	–	–	
GV4LE80/115●	–	25	–	50	70	–	
NSX160●MA150	–	–	35	50	65	90	
NSX250●MA220	–	–	35	50	65	90	
NSX400● Micrologic 1.3-M	–	–	30	42	65	90	
NSX630●	–	–	30	42	65	90	
NS800L Micrologic 2 or 5	–	–	–	–	–	130	

(3) Composition of contactors:

LC1D09...D115: 3 poles + 1 NO auxiliary contact + 1 NC auxiliary contact

To add auxiliary contacts or other accessories, please refer to the "Motor-starter solutions - Control and protection components" catalog.

(4) Replace ●● with the control circuit voltage code indicated in the table below:

	Volts ~	24	48	110	220	230	240
LC1D09...D115	50 Hz	B5	E5	F5	M5	P5	U5
	60 Hz	B6	E6	F6	M6	–	U6
	50/60 Hz	B7	E7	F7	M7	P7	U7
LC1F185	50 Hz (LX1 coil)	B5	E5	F5	M5	P5	U5
	60 Hz (LX1 coil)	–	E6	F6	M6	–	U6
	40...400 Hz (LX9 coil)	–	E7	F7	M7	P7	U7
LC1F265	40...400 Hz (LX1 coil)	B7	E7	F7	M7	P7	U7
LC1F400...800	40...400 Hz (LX1 coil)	–	E7	F7	M7	P7	U7

For other voltages available between 24 V and 660 V, or a DC control circuit, please contact our [Customer Care Center](#).

2



NSX250●MA220

+



LC1D115●●

+



ATV950D90N4

IEC standard motor starters						
Motor	Drive	Circuit breaker			Line contactor	
Power (1)	Reference	Reference (2)	Rating	I _{rm}	Reference (3) (4) (5)	
kW	HP	A	A	A		
Three-phase supply voltage: 440 V 50/60 Hz						
0.75	1	ATV950U07N4/N4E	GV2L07	2.5	33.5	LC1D09●●
1.5	2	ATV950U15N4/N4E	GV2L08	4	51	LC1D09●●
2.2	3	ATV950U22N4/N4E	GV2L10	6.3	78	LC1D09●●
3	–	ATV950U30N4/N4E	GV2L10	6.3	78	LC1D09●●
4	5	ATV950U40N4/N4E	GV2L14	10	138	LC1D09●●
5.5	7.5	ATV950U55N4/N4E	GV2L16	14	170	LC1D18●●
7.5	10	ATV950U75N4/N4E	GV2L16	14	170	LC1D18●●
11	15	ATV950D11N4/N4E	GV2L22	25	327	LC1D25●●
15	20	ATV950D15N4/N4E	GV3L32	32	448	LC1D25●●
18.5	25	ATV950D18N4/N4E	GV3L40	40	560	LC1D40A●●
22	30	ATV950D22N4/N4E	GV3L50	50	700	LC1D50A●●
30	40	ATV950D30N4/N4E	GV3L65	65	910	LC1D50A●●
37	50	ATV950D37N4/N4E	GV3L65	65	910	LC1D65A●●
45	60	ATV950D45N4/N4E	GV4L/LE80●	80	480	LC1D65A●●
55	75	ATV950D55N4/N4E	GV4L/LE115●	115	690	LC1D80●●
75	100	ATV950D75N4/N4E	NSX160●MA150	150	1,350	LC1D115●●
90	125	ATV950D90N4/N4E	NSX250●MA220	220	1,980	LC1D115●●

- (1) Standard power ratings for 400 V 50/60 Hz 4-pole motors.
The values expressed in HP conform to the NEC (National Electrical Code).
- (2) For references to be completed, replace the dot with the letter corresponding to the breaking performance of the circuit breaker (F, N, H, S or L).
Breaking capacity of circuit breakers according to standard IEC 60947-2:

Circuit breaker	I _{cu} (kA) for 440 V						
	B	F	N	H	S	L	
GV2L07...L10	>100	–	–	–	–	–	
GV2L14...L22	50	–	–	–	–	–	
GV3L32...L65	50	–	–	–	–	–	
GV4L80/115●	–	25	–	50	–	–	
GV4LE80/115●	–	25	–	50	–	70	
NSX160●MA150	–	–	35	50	65	90	
NSX250●MA220	–	–	35	50	65	90	

- (3) Composition of contactors:
LC1D09...D115: 3 poles + 1 NO auxiliary contact + 1 NC auxiliary contact
To add auxiliary contacts or other accessories, please refer to the "Motor-starter solutions - Control and protection components" catalog.
- (4) Replace ●● with the control circuit voltage code indicated in the table below:

	Volts ~						
	24	48	110	220	230	240	
LC1D09...D115	50 Hz	B5	E5	F5	M5	P5	U5
	60 Hz	B6	E6	F6	M6	–	U6
	50/60 Hz	B7	E7	F7	M7	P7	U7

- For other voltages available between 24 V and 660 V, or a DC control circuit, please contact our [Customer Care Center](#).
- (5) When used with ATV950U07N4/N4E...D90N4/N4E drives, the motor starters must be installed in a separate enclosure to maintain IP 55 protection for the installation.



GV2L10

+



LC1D09●●

+



ATV930U22Y6

IEC standard motor starters

Motor Power	Drive Reference	Circuit breaker			Line contactor	
		Reference (1)	Rating	I _{rm}	Reference	
kW	HP		A	A		
Three-phase supply voltage: 500 V 50/60 Hz						
1.5	2	ATV930U22Y6	GV2L10	6.3	78	LC1D09●●
2.2	3	ATV930U30Y6	GV2L10	6.3	78	LC1D09●●
3	–	ATV930U40Y6	GV2L14	10	138	LC1D18●●
4	5	ATV930U55Y6	GV2L14	10	138	LC1D18●●
5.5	7.5	ATV930U75Y6	GV2L16	14	170	LC1D25●●
7.5	10	ATV930D11Y6	GV2L20	18	223	LC1D25●●
11	15	ATV930D15Y6	GV2L22	25	327	LC1D40A●●
15	20	ATV930D18Y6	GV3L25	25	350	LC1D40A●●
18.5	25	ATV930D22Y6	GV3L32	32	448	LC1D40A●●
22	30	ATV930D30Y6	GV3L40	40	560	LC1D40A●●
30	40	ATV930D37Y6	GV3L50	50	700	LC1D50A●●
37	50	ATV930D45Y6	GV3L65	65	910	LC1D65A●●
45	60	ATV930D55Y6	NSX100●MA100	100	600	LC1D80●●
55	75	ATV930D75Y6	NSX100●MA100	100	600	LC1D80●●
75	100	ATV930D90Y6	NSX160●MA150	150	1,350	LC1D150●●
Three-phase supply voltage: 690 V 50/60 Hz						
2.2	3	ATV930U22Y6	GV2L08	6.3	78	LC1D09●●
3	–	ATV930U30Y6	GV2L10	10	138	LC1D09●●
4	5	ATV930U40Y6	GV2L14	10	138	LC1D18●●
5.5	7.5	ATV930U55Y6	GV2L14	14	170	LC1D18●●
7.5	10	ATV930U75Y6	GV2L16	18	223	LC1D18●●
11	15	ATV930D11Y6	GV2L20	25	327	LC1D18●●
15	20	ATV930D15Y6	GV2L22	25	327	LC1D25●●
18.5	25	ATV930D18Y6	GV3L25	32	416	LC1D40A●●
22	30	ATV930D22Y6	GV3L32	40	560	LC1D40A●●
30	40	ATV930D30Y6	GV3L40	50	700	LC1D40A●●
37	50	ATV930D37Y6	GV3L50	65	910	LC1D50A●●
45	60	ATV930D45Y6	GV3L65	100	1,100	LC1D65A●●
55	75	ATV930D55Y6	NSX100●MA100	100	600	LC1D80●●
75	100	ATV930D75Y6	NSX100●MA100	150	600	LC1D80●●
90	125	ATV930D90Y6	NSX250●MA150	150	1,980	LC1D150●●

(1) For references to be completed, replace ● with the letter corresponding to the breaking performance of the circuit breaker (H, HB1 or HB2).

Circuit breaker	Supply voltage (V)	I _{cu} (kA)			
			H	HB1	HB2
GV2L07...L10	500	>100	–	–	–
	690	4	–	–	–
GV2L14...L22	500	10	–	–	–
	690	4	–	–	–
GV2L25...L32	500	12	–	–	–
	690	4	–	–	–
GV3L40...L66	500	12	–	–	–
	690	5	–	–	–
NSX100●MA100	500	–	50	85	100
	690	–	–	75	100
NSX160●MA150	500	–	50	–	–
	690	–	–	75	100

Variable speed drives

Altivar Process ATV900

IP 21 drives: 200...240 V



200...240 V IP 21/UL Type 1 drives

Overall dimensions

Drives	W x H x D	
	mm	in.
ATV930U07M3	144 x 350 x 206	5.67 x 13.78 x 8.11
ATV930U15M3	144 x 350 x 206	5.67 x 13.78 x 8.11
ATV930U22M3	144 x 350 x 206	5.67 x 13.78 x 8.11
ATV930U30M3	144 x 350 x 206	5.67 x 13.78 x 8.11
ATV930U40M3	144 x 350 x 206	5.67 x 13.78 x 8.11
ATV930U55M3	171 x 409 x 236	6.73 x 16.10 x 9.29
ATV930U75M3	211 x 545.9 x 235	8.31 x 21.49 x 9.25
ATV930D11M3	211 x 545.9 x 235	8.31 x 21.49 x 9.25
ATV930D15M3	226 x 673 x 274	8.90 x 26.50 x 10.79
ATV930D18M3	226 x 673 x 274	8.90 x 26.50 x 10.79
ATV930D22M3	226 x 673 x 274	8.90 x 26.50 x 10.79
ATV930D30M3	290 x 922 x 325.5	11.42 x 36.30 x 12.81
ATV930D37M3	290 x 922 x 325.5	11.42 x 36.30 x 12.81
ATV930D45M3	290 x 922 x 325.5	11.42 x 36.30 x 12.81

200...240 V IP 21/UL Type 1 drives without braking unit

Overall dimensions

Drives	W x H x D	
	mm	in.
ATV930D30M3C	290 x 922 x 325.5	11.42 x 36.30 x 12.81
ATV930D37M3C	290 x 922 x 325.5	11.42 x 36.30 x 12.81
ATV930D45M3C	290 x 922 x 325.5	11.42 x 36.30 x 12.81
ATV930D55M3C	320 x 852 x 393	12.60 x 33.54 x 15.47
With kit for IP 21/UL Type 1 conformity	320 x 1,157 x 393	12.60 x 45.55 x 15.47
ATV930D75M3C	320 x 852 x 393	12.60 x 33.54 x 15.47
With kit for IP 21/UL Type 1 conformity	320 x 1,157 x 393	12.60 x 45.55 x 15.47



380...480 V IP 21/UL Type 1 and cabinet integration drives

Overall dimensions

Drives	W x H x D	
	mm	in.
ATV930U07N4	144 x 350 x 206	5.67 x 13.78 x 8.11
ATV930U07N4Z	130 x 285 x 196	5.11 x 11.22 x 7.71
ATV930U15N4	144 x 350 x 206	5.67 x 13.78 x 8.11
ATV930U15N4Z	130 x 285 x 196	5.11 x 11.22 x 7.71
ATV930U22N4	144 x 350 x 206	5.67 x 13.78 x 8.11
ATV930U22N4Z	130 x 285 x 196	5.11 x 11.22 x 7.71
ATV930U30N4	144 x 350 x 206	5.67 x 13.78 x 8.11
ATV930U30N4Z	130 x 285 x 196	5.11 x 11.22 x 7.71
ATV930U40N4	144 x 350 x 206	5.67 x 13.78 x 8.11
ATV930U40N4Z	130 x 285 x 196	5.11 x 11.22 x 7.71
ATV930U55N4	144 x 350 x 206	5.67 x 13.78 x 8.11
ATV930U55N4Z	130 x 285 x 196	5.11 x 11.22 x 7.71
ATV930U75N4	171 x 409 x 236	6.73 x 16.10 x 9.29
ATV930U75N4Z	155 x 345 x 225	6.10 x 13.58 x 8.85
ATV930D11N4	171 x 409 x 236	6.73 x 16.10 x 9.29
ATV930D11N4Z	155 x 345 x 225	6.10 x 13.58 x 8.85
ATV930D15N4	211 x 545.9 x 235	8.31 x 21.49 x 9.25
ATV930D15N4Z	195 x 480 x 225.5	7.67 x 18.89 x 8.87
ATV930D18N4	211 x 545.9 x 235	8.31 x 21.49 x 9.25
ATV930D18N4Z	195 x 480 x 225.5	7.67 x 18.89 x 8.87
ATV930D22N4	211 x 545.9 x 235	8.31 x 21.49 x 9.25
ATV930D22N4Z	195 x 480 x 225.5	7.67 x 18.89 x 8.87
ATV930D30N4	226 x 673 x 274	8.90 x 26.50 x 10.79
ATV930D30N4Z	210 x 597 x 262	8.26 x 23.50 x 10.31
ATV930D37N4	226 x 673 x 274	8.90 x 26.50 x 10.79
ATV930D37N4Z	210 x 597 x 262	8.26 x 23.50 x 10.31
ATV930D45N4	226 x 673 x 274	8.90 x 26.50 x 10.79
ATV930D45N4Z	210 x 597 x 262	8.26 x 23.50 x 10.31
ATV930D55N4	290 x 922 x 325.5	11.42 x 36.30 x 12.81
ATV930D55N4Z	265 x 748 x 307	10.43 x 29.44 x 12.08
ATV930D75N4	290 x 922 x 325.5	11.42 x 36.30 x 12.81
ATV930D75N4Z	265 x 748 x 307	10.43 x 29.44 x 12.08
ATV930D90N4	290 x 922 x 325.5	11.42 x 36.30 x 12.81
ATV930D90N4Z	265 x 748 x 307	10.43 x 29.44 x 12.08
ATV930C22N4	440 x 1195 x 380	17.32 x 47.04 x 14.96
With kit for IP 21/UL Type 1 conformity	(1)	

(1) For further information, please contact our [Customer Care Center](#).

2

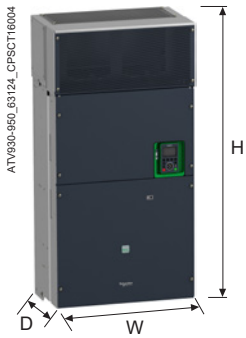
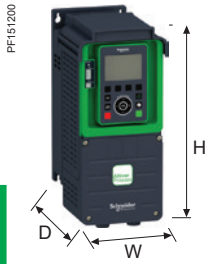

380...480 V IP 21/UL Type 1 drives without braking unit

Overall dimensions

Drives	W x H x D	
	mm	in.
ATV930D55N4C	290 x 922 x 325.5	11.42 x 36.30 x 12.81
ATV930D75N4C	290 x 922 x 325.5	11.42 x 36.30 x 12.81
ATV930D90N4C	290 x 922 x 325.5	11.42 x 36.30 x 12.81
ATV930C11N4C	320 x 852 x 393	12.60 x 33.54 x 15.47
With kit for IP 21/UL Type 1 conformity	(1)	
ATV930C13N4C	320 x 852 x 393	12.60 x 33.54 x 15.47
With kit for IP 21/UL Type 1 conformity	(1)	
ATV930C16N4C	320 x 852 x 393	12.60 x 33.54 x 15.47
With kit for IP 21/UL Type 1 conformity	(1)	
ATV930C22N4C	440 x 1195 x 380	17.32 x 47.04 x 14.96
With kit for IP 21/UL Type 1 conformity	(1)	
ATV930C25N4C	598 x 1195 x 380	23.54 x 47.04 x 14.96
With kit for IP 21/UL Type 1 conformity	(1)	
ATV930C31N4C	598 x 1195 x 380	23.54 x 47.04 x 14.96
With kit for IP 21/UL Type 1 conformity	(1)	

(1) For further information, please contact our [Customer Care Center](#).

Variable speed drives

Altivar Process ATV900
IP 00 drives: 500...690 V and
IP 21 drives: 380...440 V



500...690 V IP 00 drives

Overall dimensions

Drives	W x H x D	
	mm	in.
ATV930U22Y6	246 x 420 x 242	9.68 x 16.5 x 9.52
With kit for IP 20/UL Type 1 conformity	246 x 567 x 242	9.68 x 22.32 x 9.52
ATV930U30Y6	246 x 420 x 242	9.68 x 16.5 x 9.52
With kit for IP 20/UL Type 1 conformity	246 x 567 x 242	9.68 x 22.32 x 9.52
ATV930U40Y6	246 x 420 x 242	9.68 x 16.5 x 9.52
With kit for IP 20/UL Type 1 conformity	246 x 567 x 242	9.68 x 22.32 x 9.52
ATV930U55Y6	246 x 420 x 242	9.68 x 16.5 x 9.52
With kit for IP 20/UL Type 1 conformity	246 x 567 x 242	9.68 x 22.32 x 9.52
ATV930U75Y6	246 x 420 x 242	9.68 x 16.5 x 9.52
With kit for IP 20/UL Type 1 conformity	246 x 567 x 242	9.68 x 22.32 x 9.52
ATV930D11Y6	246 x 420 x 242	9.68 x 16.5 x 9.52
With kit for IP 20/UL Type 1 conformity	246 x 567 x 242	9.68 x 22.32 x 9.52
ATV930D15Y6	246 x 420 x 242	9.68 x 16.5 x 9.52
With kit for IP 20/UL Type 1 conformity	246 x 567 x 242	9.68 x 22.32 x 9.52
ATV930D18Y6	246 x 420 x 242	9.68 x 16.5 x 9.52
With kit for IP 20/UL Type 1 conformity	246 x 567 x 242	9.68 x 22.32 x 9.52
ATV930D22Y6	246 x 420 x 242	9.68 x 16.5 x 9.52
With kit for IP 20/UL Type 1 conformity	246 x 567 x 242	9.68 x 22.32 x 9.52
ATV930D30Y6	246 x 420 x 242	9.68 x 16.5 x 9.52
With kit for IP 20/UL Type 1 conformity	246 x 567 x 242	9.68 x 22.32 x 9.52
ATV930D37Y6	331 x 630 x 297	13.03 x 24.80 x 11.69
With kit for IP 20/UL Type 1 conformity	331 x 822 x 297	13.03 x 32.36 x 11.69
ATV930D45Y6	331 x 630 x 297	13.03 x 24.80 x 11.69
With kit for IP 20/UL Type 1 conformity	331 x 822 x 297	13.03 x 32.36 x 11.69
ATV930D55Y6	331 x 630 x 297	13.03 x 24.80 x 11.69
With kit for IP 20/UL Type 1 conformity	331 x 822 x 297	13.03 x 32.36 x 11.69
ATV930D75Y6	331 x 630 x 297	13.03 x 24.80 x 11.69
With kit for IP 20/UL Type 1 conformity	331 x 822 x 297	13.03 x 32.36 x 11.69
ATV930D90Y6	331 x 630 x 297	13.03 x 24.80 x 11.69
With kit for IP 20/UL Type 1 conformity	331 x 822 x 297	13.03 x 32.36 x 11.69

Floor-standing 380...440 V IP 21 drives

Overall dimensions

Drives	W x H x D (1)	
	mm	in.
ATV930C11N4F	400 x 2,150 x 642	15.75 x 84.65 x 25.28
ATV930C13N4F	400 x 2,150 x 642	15.75 x 84.65 x 25.28
ATV930C16N4F	400 x 2,150 x 642	15.75 x 84.65 x 25.28
ATV930C20N4F	600 x 2,150 x 642	23.62 x 84.65 x 25.28
ATV930C25N4F	600 x 2,150 x 642	23.62 x 84.65 x 25.28
ATV930C31N4F	600 x 2,150 x 642	23.62 x 84.65 x 25.28

(1) The total depth includes a door handle of 42 mm/1.65 in.



Variable speed drives

Altivar Process ATV900

IP 55 drives: 380...480 V and IP 54 drives: 380...440 V

2



380...480 V IP 55 drives

Overall dimensions		
Drives	W x H x D	
	mm	in.
ATV950U07N4	264 x 678 x 272	10.39 x 26.69 x 10.71
ATV950U15N4	264 x 678 x 272	10.39 x 26.69 x 10.71
ATV950U22N4	264 x 678 x 272	10.39 x 26.69 x 10.71
ATV950U30N4	264 x 678 x 272	10.39 x 26.69 x 10.71
ATV950U40N4	264 x 678 x 272	10.39 x 26.69 x 10.71
ATV950U55N4	264 x 678 x 272	10.39 x 26.69 x 10.71
ATV950U75N4	264 x 678 x 299	10.39 x 26.69 x 11.77
ATV950D11N4	264 x 678 x 299	10.39 x 26.69 x 11.77
ATV950D15N4	264 x 678 x 299	10.39 x 26.69 x 11.77
ATV950D18N4	264 x 678 x 299	10.39 x 26.69 x 11.77
ATV950D22N4	264 x 678 x 299	10.39 x 26.69 x 11.77
ATV950D30N4	290 x 910 x 340	11.42 x 35.83 x 13.39
ATV950D37N4	290 x 910 x 340	11.42 x 35.83 x 13.39
ATV950D45N4	290 x 910 x 340	11.42 x 35.83 x 13.39
ATV950D55N4	345 x 1,250 x 375	13.58 x 49.21 x 14.76
ATV950D75N4	345 x 1,250 x 375	13.58 x 49.21 x 14.76
ATV950D90N4	345 x 1,250 x 375	13.58 x 49.21 x 14.76

380...480 V IP 55 drives with Vario disconnect switch

Drives	W x H x D (1)	
	mm	in.
ATV950U07N4E	264 x 678 x 300	10.39 x 26.69 x 11.81
ATV950U15N4E	264 x 678 x 300	10.39 x 26.69 x 11.81
ATV950U22N4E	264 x 678 x 300	10.39 x 26.69 x 11.81
ATV950U30N4E	264 x 678 x 300	10.39 x 26.69 x 11.81
ATV950U40N4E	264 x 678 x 300	10.39 x 26.69 x 11.81
ATV950U55N4E	264 x 678 x 330	10.39 x 26.69 x 12.99
ATV950U75N4E	264 x 678 x 330	10.39 x 26.69 x 12.99
ATV950D11N4E	264 x 678 x 330	10.39 x 26.69 x 12.99
ATV950D15N4E	264 x 678 x 330	10.39 x 26.69 x 12.99
ATV950D18N4E	264 x 678 x 330	10.39 x 26.69 x 12.99
ATV950D22N4E	264 x 678 x 330	10.39 x 26.69 x 12.99
ATV950D30N4E	290 x 910 x 401	11.42 x 35.83 x 15.79
ATV950D37N4E	290 x 910 x 401	11.42 x 35.83 x 15.79
ATV950D45N4E	290 x 910 x 401	11.42 x 35.83 x 15.79
ATV950D55N4E	345 x 1,250 x 436	13.58 x 49.21 x 17.17
ATV950D75N4E	345 x 1,250 x 436	13.58 x 49.21 x 17.17
ATV950D90N4E	345 x 1,250 x 436	13.58 x 49.21 x 17.17

Floor-standing 380...440 V IP 54 drives

Overall dimensions		
Drives	W x H x D (2)	
	mm	in.
ATV950C11N4F	400 x 2,350 x 664	15.75 x 92.52 x 26.14
ATV950C13N4F	400 x 2,350 x 664	15.75 x 92.52 x 26.14
ATV950C16N4F	400 x 2,350 x 664	15.75 x 92.52 x 26.14
ATV950C20N4F	600 x 2,350 x 664	23.62 x 92.52 x 26.14
ATV950C25N4F	600 x 2,350 x 664	23.62 x 92.52 x 26.14
ATV950C31N4F	600 x 2,350 x 664	23.62 x 92.52 x 26.14

(1) The total depth includes a door handle of 64 mm/2.54 in.

(2) The total depth includes a door handle of 64 mm/2.54 in. The total height includes a plinth of 200 mm/7.87 in.

Braking units		
Overall dimensions		
Braking units	W x H x D	
	mm	in.
VW3A7101	103 x 1190 x 380	4.035 x 46.85 x 14.96
VW3A7102	310 x 1150 x 380	12.20 x 45.27 x 14.96
VW3A7105	216 x 658 x 303	8.50 x 25.91 x 11.93
VW3A7106	216 x 658 x 303	8.50 x 25.91 x 11.93

Braking resistors		
Overall dimensions		
Braking resistors	W x H x D	
	mm	in.
VW3A7730	105 x 295 x 100	4.13 x 11.61 x 3.94
VW3A7731	105 x 345 x 100	4.13 x 13.58 x 3.94
VW3A7732	175 x 345 x 100	6.89 x 13.58 x 3.94
VW3A7733	190 x 570 x 180	7.48 x 22.44 x 7.09
VW3A7734	190 x 640 x 180	7.48 x 25.20 x 7.09
VW3A7735	190 x 640 x 180	7.48 x 25.20 x 7.09
VW3A7736	485 x 410 x 485	19.09 x 16.14 x 19.09
VW3A7737	485 x 410 x 485	19.09 x 16.14 x 19.09
VW3A7738	485 x 410 x 445	19.09 x 16.14 x 17.52
VW3A7740	105 x 465 x 100	4.13 x 18.31 x 3.94
VW3A7741	175 x 465 x 100	6.89 x 18.31 x 3.94
VW3A7742	190 x 570 x 180	7.48 x 22.44 x 7.09
VW3A7743	290 x 570 x 180	11.42 x 22.44 x 7.09
VW3A7744	450 x 490 x 180	17.72 x 19.29 x 7.09
VW3A7745	485 x 610 x 485	19.09 x 24.02 x 19.09
VW3A7746	485 x 610 x 485	19.09 x 24.02 x 19.09
VW3A7747	485 x 1020 x 485	19.09 x 40.16 x 19.09
VW3A7748	485 x 610 x 485	19.09 x 24.02 x 19.09
VW3A7750	290 x 570 x 180	11.42 x 22.44 x 7.09
VW3A7751	390 x 570 x 180	15.35 x 22.44 x 7.09
VW3A7752	485 x 610 x 485	19.09 x 24.02 x 19.09
VW3A7753	485 x 1,020 x 605	19.09 x 40.16 x 23.82
VW3A7754	485 x 820 x 1,035	19.09 x 32.28 x 40.75
VW3A7755	485 x 1,020 x 1,035	19.09 x 40.16 x 40.75
VW3A7756	485 x 1,020 x 1,285	19.09 x 40.16 x 50.59
VW3A7757	485 x 1,020 x 1,285	19.09 x 40.16 x 50.59

Passive filters: 400 V 50 Hz three-phase supply		
Overall dimensions		
Passive filters	W x H x D	
	mm	in.
VW3A46101	190 x 332.11 x 205.5	7.48 x 13.08 x 8.09
VW3A46102	190 x 332.11 x 205.5	7.48 x 13.08 x 8.09
VW3A46103	190 x 332.11 x 205.5	7.48 x 13.08 x 8.09
VW3A46104	232 x 436.11 x 247.5	9.13 x 17.17 x 9.74
VW3A46105	232 x 436.11 x 247.5	9.13 x 17.17 x 9.74
VW3A46106	378 x 594.08 x 242	14.88 x 23.39 x 9.53
VW3A46107	378 x 594.08 x 242	14.88 x 23.39 x 9.53
VW3A46108	378 x 623.6 x 333	14.88 x 24.55 x 13.11
VW3A46109	378 x 623.6 x 333	14.88 x 24.55 x 13.11
VW3A46110	418 x 736.8 x 333	16.46 x 29.01 x 13.11
VW3A46111	418 x 736.8 x 333	16.46 x 29.01 x 13.11
VW3A46112	418 x 767.6 x 400	16.46 x 30.22 x 15.75
VW3A46113	418 x 767.6 x 400	16.46 x 30.22 x 15.75
VW3A46114	468 x 900.06 x 448.5	18.42 x 35.43 x 17.66
VW3A46115	468 x 900.06 x 448.5	18.42 x 35.43 x 17.66
VW3A46116	468 x 900.06 x 448.5	18.42 x 35.43 x 17.66
VW3A46118	468 x 900.06 x 448.5	18.42 x 35.43 x 17.66
VW3A46119	468 x 900.06 x 510	18.42 x 35.43 x 20.00
VW3A46120	190 x 332.11 x 205.5	7.48 x 13.08 x 8.09
VW3A46121	190 x 332.11 x 205.5	7.48 x 13.08 x 8.09
VW3A46122	190 x 332.11 x 205.5	7.48 x 13.08 x 8.09
VW3A46123	232 x 436.11 x 247.5	9.13 x 17.17 x 9.74
VW3A46124	232 x 436.11 x 247.5	9.13 x 17.17 x 9.74
VW3A46125	378 x 594.08 x 242	14.88 x 23.39 x 9.53
VW3A46126	378 x 594.08 x 242	14.88 x 23.39 x 9.53
VW3A46127	378 x 623.6 x 333	14.88 x 24.55 x 13.11
VW3A46128	378 x 623.6 x 333	14.88 x 24.55 x 13.11
VW3A46129	418 x 736.8 x 333	16.46 x 29.01 x 13.11
VW3A46130	418 x 736.8 x 333	16.46 x 29.01 x 13.11
VW3A46131	418 x 767.6 x 400	16.46 x 30.22 x 15.75
VW3A46132	418 x 767.6 x 400	16.46 x 30.22 x 15.75
VW3A46133	468 x 900.06 x 448.5	18.42 x 35.43 x 17.66
VW3A46134	468 x 900.06 x 448.5	18.42 x 35.43 x 17.66
VW3A46135	468 x 900.06 x 510	18.42 x 35.43 x 20.00
VW3A46137	468 x 900.06 x 510	18.42 x 35.43 x 20.00
VW3A46138	468 x 900.06 x 510	18.42 x 35.43 x 20.00
VW3A46139	190 x 332.11 x 205.5	7.48 x 13.08 x 8.09
VW3A46140	190 x 332.11 x 205.5	7.48 x 13.08 x 8.09
VW3A46141	190 x 332.11 x 205.5	7.48 x 13.08 x 8.09
VW3A46142	232 x 436.11 x 247.5	9.13 x 17.17 x 9.74
VW3A46143	232 x 436.11 x 247.5	9.13 x 17.17 x 9.74
VW3A46144	378 x 594.08 x 242	14.88 x 23.39 x 9.53
VW3A46145	378 x 594.08 x 242	14.88 x 23.39 x 9.53
VW3A46146	378 x 594.08 x 242	14.88 x 23.39 x 9.53
VW3A46147	378 x 623.6 x 333	14.88 x 24.55 x 13.11
VW3A46148	378 x 623.6 x 333	14.88 x 24.55 x 13.11
VW3A46149	418 x 736.8 x 333	16.46 x 29.01 x 13.11
VW3A46150	418 x 736.8 x 333	16.46 x 29.01 x 13.11

Passive filters: 460 V 60 Hz three-phase supply		
Overall dimensions		
Passive filters	W x H x D	
	mm	in.
VW3A46151	418 x 767.6 x 400	16.46 x 30.22 x 15.75
VW3A46152	418 x 767.6 x 400	16.46 x 30.22 x 15.75
VW3A46153	468 x 900.06 x 448.5	18.42 x 35.43 x 17.66
VW3A46154	468 x 900.06 x 448.5	18.42 x 35.43 x 17.66
VW3A46155	468 x 900.06 x 448.5	18.42 x 35.43 x 17.66
VW3A46157	468 x 900.06 x 510	18.42 x 35.43 x 20.00
VW3A46158	190 x 332.11 x 205.5	7.48 x 13.08 x 8.09
VW3A46159	190 x 332.11 x 205.5	7.48 x 13.08 x 8.09
VW3A46160	190 x 332.11 x 205.5	7.48 x 13.08 x 8.09
VW3A46161	232 x 436.11 x 247.5	9.13 x 17.17 x 9.74
VW3A46162	232 x 436.11 x 247.5	9.13 x 17.17 x 9.74
VW3A46163	378 x 594.08 x 242	14.88 x 23.39 x 9.53
VW3A46164	378 x 594.08 x 242	14.88 x 23.39 x 9.53
VW3A46165	378 x 594.08 x 242	14.88 x 23.39 x 9.53
VW3A46166	378 x 623.6 x 333	14.88 x 24.55 x 13.11
VW3A46167	378 x 623.6 x 333	14.88 x 24.55 x 13.11
VW3A46168	418 x 736.8 x 333	16.46 x 29.01 x 13.11
VW3A46169	418 x 736.8 x 333	16.46 x 29.01 x 13.11
VW3A46170	418 x 767.6 x 400	16.46 x 30.22 x 15.75
VW3A46171	418 x 767.6 x 400	16.46 x 30.22 x 17.75
VW3A46172	468 x 900.06 x 448.5	18.42 x 35.43 x 17.66
VW3A46173	468 x 900.06 x 510	18.42 x 35.43 x 20.00
VW3A46174	468 x 900.06 x 510	18.42 x 35.43 x 20.00
VW3A46176	468 x 900.06 x 510	18.42 x 35.43 x 20.00

Additional EMC input filters

Overall dimensions

EMC filters	W x H x D	
	mm	in.
VW3A4411	800 x 261 x 139	31.49 x 10.27 x 5.47
VW3A4701	75 x 220 x 130	2.95 x 8.66 x 5.12
VW3A4702	75 x 240 x 140	2.95 x 9.45 x 5.51
VW3A4703	80 x 302 x 155	3.15 x 11.89 x 6.10
VW3A4704	90 x 283 x 165	3.54 x 11.14 x 6.50
VW3A4705	100 x 328 x 175	3.94 x 12.91 x 6.89
VW3A4706	120 x 340 x 180	4.72 x 13.39 x 7.09
VW3A4707	130 x 395 x 240	5.12 x 15.55 x 9.45
VW3A4708	200 x 455 x 320	7.87 x 17.91 x 12.60
VW3A4709	260 x 520 x 117	10.24 x 20.47 x 4.61
VW3A4710	260 x 520 x 117	10.24 x 20.47 x 4.61

dv/dt filters

Overall dimensions

dv/dt filters	W x H x D	
	mm	in.
VW3A5103	234 x 226 x 126	9.21 x 9.21 x 4.96
VW3A5104	170 x 250 x 100	6.69 x 9.84 x 3.94
VW3A5106	245 x 250 x 139	9.65 x 9.84 x 7.87
VW3A5107	320 x 250 x 220	12.60 x 9.84 x 8.66
VW3A5301	285 x 530 x 215	10.79 x 20.33 x 8.17
VW3A5302	285 x 530 x 215	10.79 x 20.33 x 8.17
VW3A5303	285 x 530 x 215	10.79 x 20.33 x 8.17
VW3A5304	300 x 560 x 245	11.44 x 21.32 x 9.35
VW3A5305	300 x 610 x 245	11.44 x 23.09 x 9.35
VW3A5306	380 x 325 x 235	14.57 x 8.82 x 12.43
VW3A5307	420 x 350 x 270	15.75 x 9.72 x 13.41

Variable speed drives

Altivar Process ATV900
AC chokes, sinus filters and
common mode filters

AC Chokes

Overall dimensions

AC Chokes	W x H x D	
	mm	in.
VW3A4551	100 x 35 x 60	3.93 x 1.37 x 2.36
VW3A4552	130 x 55 x 90	5.11 x 2.16 x 3.54
VW3A4553	130 x 55 x 90	5.11 x 2.16 x 3.54
VW3A4554	155 x 170 x 135	6.10 x 6.69 x 5.31
VW3A4555	180 x 210 x 165	7.08 x 8.26 x 6.49
VW3A4556	270 x 210 x 180	10.62 x 8.26 x 7.08

Sinus filters

Overall dimensions

Sinus filters	W x H x D	
	mm	in.
VW3A5209	480 x 340 x 600	18.9 x 13.38 x 23.62
VW3A5210	480 x 370 x 710	18.9 x 14.57 x 27.95
VW3A5401	210 x 455 x 210	8.03 x 17.32 x 7.91
VW3A5402	210 x 455 x 210	8.03 x 17.32 x 7.91
VW3A5403	280 x 530 x 215	10.79 x 20.33 x 8.17
VW3A5404	300 x 560 x 245	11.46 x 21.32 x 9.35
VW3A5405	375 x 760 x 280	14.59 x 29.00 x 10.75
VW3A5406	430 x 325 x 495	16.54 x 12.56 x 18.92
VW3A5407	460 x 370 x 565	17.72 x 14.19 x 21.59
VW3A5215	246 x 420 x 242	9.68 x 16.53 x 9.52
VW3A5216	171 x 409 x 233	6.73 x 16.10 x 9.17
VW3A5217	331 x 822 x 297	13.03 x 32.36 x 11.69
VW3A5218	331 x 822 x 297	13.03 x 32.36 x 11.69
VW3A5219	331 x 822 x 297	13.03 x 32.36 x 11.69
VW3A5215	246 x 420 x 242	9.68 x 16.53 x 9.52
VW3A5216	171 x 409 x 233	6.73 x 16.10 x 9.17
VW3A5217	331 x 822 x 297	13.03 x 32.36 x 11.69
VW3A5218	331 x 822 x 297	13.03 x 32.36 x 11.69
VW3A5219	331 x 822 x 297	13.03 x 32.36 x 11.69

Common mode filters

Overall dimensions

Common mode filters	W x H x D	
	mm	in.
VW3A5501	66 x 119.2 x 66	2.60 x 4.69 x 2.60
VW3A5502	66 x 163.8 x 66	2.60 x 6.45 x 2.60
VW3A5503	127.5 x 161 x 127.5	5.02 x 6.34 x 5.02
VW3A5504	127.5 x 210 x 127.5	5.02 x 8.27 x 5.02
VW3A5505	191 x 197 x 196	7.52 x 7.76 x 7.72
VW3A5506	191 x 256 x 196	7.52 x 10.08 x 7.72

3 - Drives for integration

- Presentation..... [page 3/2](#)
- Drive products for integration 380...480 V [page 3/6](#)
- 400 V 50/60 Hz supply standard..... [page 3/8](#)
- 440 V 50/60 Hz supply standard..... [page 3/9](#)
- 480 V 50/60 Hz supply standard..... [page 3/10](#)
- 500 V 50/60 Hz supply standard..... [page 3/11](#)
- 600 V 50/60 Hz supply standard..... [page 3/12](#)
- 690 V 50/60 Hz supply standard..... [page 3/13](#)
- 500 V 50/60 Hz supply Low Harmonic/Regen [page 3/14](#)
- 600 V 50/60 Hz supply Low Harmonic/Regen [page 3/15](#)
- 690 V 50/60 Hz supply Low Harmonic/Regen [page 3/15](#)



Variable speed drives

Altivar Process ATV900

Drives for integration



Drives for cabinet integration

3

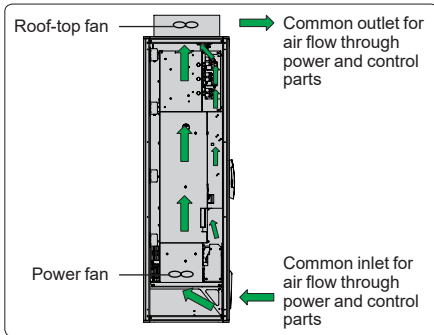

IP 20, 21, 23, 40, 41, 43/UL Type 1 integration with a common cooling air flow

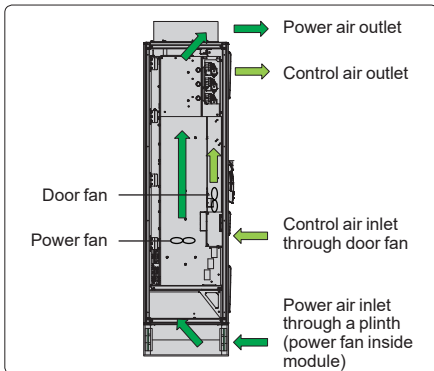

IP54/UL Type 12 integration with a separated cooling air flow

General presentation of the offer

Altivar Process for cabinet integration is a cost effective drives solution for installation into cabinets and separate enclosures with its compact and robust design. These drives variants simplify cabinet design and allow quick installation and commissioning. Altivar Process also offer a range of low harmonic drives.

Altivar Process Modular concept

Altivar Process Modular is ready to build into cabinets to create high power drive solutions with minimum dimensions that withstand harsh environments.

A powerful drives range from 75 kW up to 800 kW at 400 V supply voltage and up to 1200 kW at 690 V supply voltage can be created by combining sub-assemblies and accessories such as power modules, control units, options, and mechanical accessories.

Altivar Process Modular brings a new approach using sub-assemblies to build locally single drives:

- A power module part to be combined in different single drive architectures
- Control units that make the drive family differentiation of the power architecture between the ATV600 and ATV900 families
- Optional kits and accessories for easy enclosure integration

Optimized cabinet design

Altivar Process Modular drives offer has been developed to reduce the engineering time required to design cabinet mounted drives solutions, consequently decreasing the time to market and the cost of the solution.

Altivar Process Modular brings flexible solutions for special integration constraints as well as standard integration in 2 m/6.56 ft height and 600 mm/23.62 in. depth cabinets with IP 21 (UL Type 1)/IP 54 (UL Type 12) protection and robust design.

These power intensive single drives offers integrate:

- Drive power and control modules
- Line chokes to limit THDi levels for standard version and less than 3% THDi for Low Harmonic/Regen version
- A filter to help protect the motor against the effects of dv/dt
- Accessible terminals to simplify the motor wiring and power wiring

IP 21 (UL Type 1) integration type creates a common cooling air flow for the power and control parts.

The IP 54 (UL Type 12) mechanical option introduces a system for separating the cooling air flow between the power and control parts, allowing operation in a highly polluted environment as well as optimum management of thermal stress in the plant room. Both designs allow incoming air temperature up to + 50 °C/122 °F with derating (class 3K3 according to IEC/EN 60721-3-3).

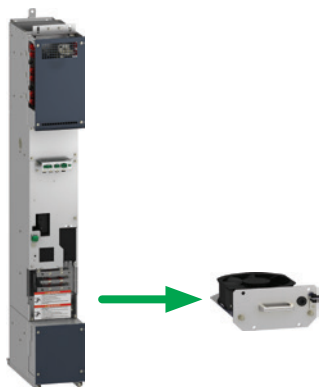

Power module and power fan inside drawer

Product features

The Altivar Process Modular drives offer has been developed to meet the most demanding applications and enclosure requirements and the most recent standards and regulations.

Compliance with electromagnetic compatibility requirements has been incorporated into the design of the modular process drives, which simplifies installation and provides an economical means of helping to ensure equipment meets marking requirements.

- Altivar Process Modular drives have category C3 EMC filters and highly efficient integrated motor filters for dv/dt and common mode reduction and voltage peak limitation that allow 300 m/980 ft of shielded motor cables (category C3 environment) and 500 m/1640 ft of unshielded motor cables (category C4 environment).
- THDi \leq 48% for 80 to 100% load, which is used to maintain an optimum power factor on the most common operating range
- Embedded Line choke technology complying with standard IEC 61000-3-12
- Prewired, tested electric core components by Schneider Electric laboratories and test centers

Simple maintenance

Altivar Process Modular drives can significantly cut downtime of your assets by means of easily replaceable core components:

- Same power module with optimized weight and wheels for standard single drives for all power ranges
- Same power fan inside a drawer accessible from front face for all power modules
- Spare parts designed for easy and fast intervention in the field



Low harmonic/regen single drive

3

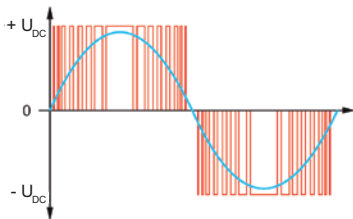

2-level technology

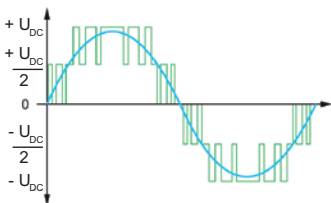

3-level technology

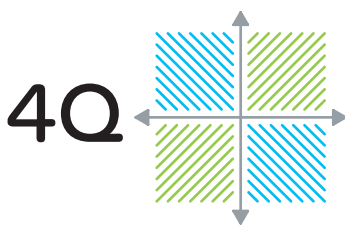

4-quadrant technology

General presentation of the offer (continued)

Low harmonic/regen single drives

The low harmonic/regenerative single drives are used when drives need to generate particularly low harmonics on the mains.

In addition, low harmonic/regen single drives are capable of feeding energy back to the mains, enabling a 4Q operation and improving overall application efficiency.

In comparison with commonly-used 2-level AFE (active front end) architectures, the 3-level technology of Altivar Process Modular Low Harmonic/Regen single drives allows this new technology to reach a total distortion factor (THDi) of around 2% and thus fulfills the requirements of standard IEEE 519 for a THDi < 5% in case of distorted mains. Additionally, the $\cos \Phi \approx 1$ in each load situation helps to reduce the line supply load.

The low harmonic/regen single drives range is an optimum solution for energy efficiency and process optimization.

Device features

Enhanced motor lifetime due to the 3-level concept

The 3-level AIF (active infeed converter) technology reduces the voltage load at the motor significantly, compared with other low harmonic frequency inverters. The fluctuating adaptation of the DC link voltage helps to extend the motor lifetime.

Reduced losses due to the 3-level concept

In comparison with the traditional circuit structure of active mains rectifiers, the switching frequency is increased and the current load is reduced at the same time when using 3-level technology.

Compact dimensions due to the 3-level concept

A significant advantage of the 3-level technology is the reduced size of the integrated filter. Due to the increased switching frequency and its location inside the forced cooling air channel, the dimensions of the filter can be almost halved.

Altivar Process Modular

Drive Integration Partner Program



Altivar Process Modular standard architecture from 1 to 6 modules



Altivar Process Modular LH/Regen architecture from 1 to 6 modules

Altivar Process Modular program

The Altivar Process modular program is dedicated to trained and qualified partners within Schneider Electric Partner Network, bringing Schneider Electric high quality power intensive drive solutions to End Users.

This program recognizes our partners as they are able to:

- Build customized panels and high power drives solutions by paralleling drive modules up to 800 kW (1100 HP) in 380...480 V supply voltage and 1200 kW (1200 HP) in 500...690 V supply voltage
- Access the download area of partner portal and find all datasheets, dimensions and drawing in different file formats, EPLAN marcos, selection tool for electric and mechanical parts, external components for line side of the drive:

<http://www.schneider-electric.com/en/partners/>

Drive products for integration

Drive products for integration can be used for optimizing space when integrated inside cabinets. They cover motor power ratings from 1...90 kW/22...120.7 HP for 380...480 V three-phase voltages.

Three-phase power supply - 380...480 V (-15...10%)

Motor power	Degree of protection	Reference
0.75...22 kW 1...30 HP	IP 20	ATV930U07N4Z...D22N4Z
30...90 kW 40...120 HP	IP 20	ATV930D30N4Z...D90N4Z

Modular single drives

Modular single drives solutions can be built using power modules, control units and accessories. They cover motor power ratings from 75...1200 kW/125...1200 HP for 380...690 V three-phase voltages.

Three-phase power supply - 380...480 V (-15...10%)

Motor power	Degree of protection	Reference
110...800 kW 150...1100 HP	IP 00	ATV9A0C11Q4...C80Q4 ATV9A0C11R4...C80R4 ATV9A0C11T4...C80T4

Three-phase power supply - 500...690 V (-15...10%) standard

Motor power	Degree of protection	Reference
75...1200 kW 125...1200 HP	IP 00	ATV9A0C11N6...M12N6 ATV9A0C11T6...M12T6 ATV9A0C11Q6...M12Q6

Three-phase power supply - 500...690 V (-15...10%) LH/Regen

Motor power	Degree of protection	Reference
75...1200 kW 125...1200 HP	IP 00	ATV9B0C11N6...M12N6 ATV9B0C11T6...M12T6 ATV9B0C11Q6...M12Q6

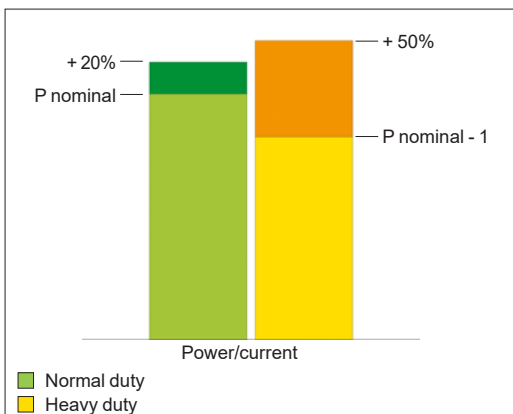

Normal duty and Heavy duty modes

Altivar Process Modular variable speed drives are designed for use in two operating modes that can optimize the drive nominal rating according to the system constraints.

These two modes are:

- Normal duty (ND): Dedicated mode for applications requiring a slight overload up to 120% with a motor power no higher than the drive nominal power
- Heavy duty (HD): Dedicated mode for applications requiring a significant overload up to 150% with a motor power no higher than the drive nominal power derated by one rating

Variable speed drives

Drives for integration

Three-phase supply voltage 380...480 V 50/60 Hz

Drive products for integration



ATV930U75N4Z

380...480 V (-15...10%) 50/60 Hz drive products for cabinet integration										
Motor			Line supply				Altivar Process			
Power indicated on rating plate (1)			Line current (2)		Apparent power 380 V	Prospective line Isc	Maximum continuous current (1)	Maximum transient current for 60 s	Reference	Weight kg/ lb
			380 V	480 V						
ND: Normal duty (3)										
HD: Heavy duty (4)										
kW	HP		A	A	kVA	kA	A	A		
With category C2 or C3 integrated EMC filter										
IP 20 drives										
ND	0.75	1	1.5	1.3	1.1	50	2.2	2.6	ATV930U07N4Z	–
HD	0.37	0.5	0.9	0.8	0.7	50	1.5	2.3		
ND	1.5	2	3	2.6	2.2	50	4	4.8	ATV930U15N4Z	–
HD	0.75	1	1.7	1.5	1.2	50	2.2	3.3		
ND	2.2	3	4.3	3.8	3.2	50	5.6	6.7	ATV930U22N4Z	–
HD	1.5	2	3.1	2.9	2.4	50	4	6		
ND	3	–	5.8	5.1	4.2	50	7.2	8.6	ATV930U30N4Z	–
HD	2.2	3	4.5	4	3.3	50	5.6	8.4		
ND	4	5	7.6	6.7	5.6	50	9.3	11.2	ATV930U40N4Z	–
HD	3	–	6	5.4	4.5	50	7.2	10.8		
ND	5.5	7.5	10.4	9.1	7.6	50	12.7	15.2	ATV930U55N4Z	–
HD	4	5	8	7.2	6.0	50	9.3	14		
ND	7.5	10	13.8	11.9	9.9	50	16.5	19.8	ATV930U75N4Z	–
HD	5.5	7.5	10.5	9.2	7.6	50	12.7	19.1		
ND	11	15	19.8	17	14.1	50	23.5	28.2	ATV930D11N4Z	–
HD	7.5	10	14.1	12.5	10.4	50	16.5	24.8		
ND	15	20	27	23.3	19.4	50	31.7	38	ATV930D15N4Z	–
HD	11	15	20.6	18.1	15	50	23.5	35.3		
ND	18.5	25	33.4	28.9	24	50	39.2	47	ATV930D18N4Z	–
HD	15	20	27.7	24.4	20.3	50	31.7	47.6		
ND	22	30	39.6	34.4	28.6	50	46.3	55.6	ATV930D22N4Z	–
HD	18.5	25	34.1	29.9	24.9	50	39.2	58.8		

(1) These values are given for use in continuous operation with a nominal switching frequency of 4 kHz (ATV930U07N4Z...D45N4Z).

The switching frequency is adjustable from 2...12 kHz (ATV930U07N4Z...D45N4Z).

Above the nominal switching frequency, the drive will automatically reduce it in the event of an excessive temperature rise.

For continuous operation above the nominal switching frequency, nominal drive current should be derated according to the derating curves available on www.schneider-electric.com.

(2) Typical value for the indicated motor power and for the maximum prospective line Isc.

(3) Values given for applications requiring a slight overload (up to 120%).

(4) Values given for applications requiring a significant overload (up to 150%).

Note: Consult the summary tables of possible drive, option, and accessory combinations (see [page 2/18](#)).

Variable speed drives

Drives for integration

Three-phase supply voltage 380...480 V 50/60 Hz

Drive products for integration

ATV930_62317_CPM6U18013



ATV930D30N4Z

380...480 V (-15...10%) 50/60 Hz drive products for cabinet integration										
Motor		Line supply				Altivar Process				
Power indicated on rating plate (1)		Line current (2)		Apparent power	Prospective line	Maximum continuous current (1)	Maximum transient current for 60 s	Reference	Weight	
380 V	480 V	380 V	Isc							
ND:	Normal duty (3)									
HD:	Heavy duty (4)									
kW	HP	A	A	kVA	kA	A	A			
With category C2 or C3 integrated EMC filter										
IP 20 drives (5)										
ND	30	40	53.3	45.9	38.2	50	61.5	73.8	ATV930D30N4Z	–
HD	22	30	40.5	35.8	29.8	50	46.3	69.5		
ND	37	50	66.2	57.3	47.6	50	74.5	89.4	ATV930D37N4Z	–
HD	30	40	54.8	48.3	40.2	50	61.5	92.3		
ND	45	60	79.8	69.1	57.4	50	88	105.6	ATV930D45N4Z	–
HD	37	50	67.1	59	49.1	50	74.5	111.8		
ND	55	75	97.2	84.2	70	50	106	127.2	ATV930D55N4Z	–
HD	45	60	81.4	71.8	59.7	50	88	132		
ND	75	100	131.3	112.7	93.7	50	145	174	ATV930D75N4Z	–
HD	55	75	98.9	86.9	72.2	50	106	159		
ND	90	125	156.2	135.8	112.9	50	173	207.6	ATV930D90N4Z	–
HD	75	100	134.3	118.1	98.2	50	145	217.5		

EMC plates for ATV930...N4Z

For drive	Plate reference	Weight kg/lb
ATV930U07N4Z...U55N4Z	VW3A47801	–
ATV930U75N4Z, D11N4Z	VW3A47802	–
ATV930D15N4Z...D22N4Z	VW3A47803	–
ATV930D30N4Z..D37N4Z	VW3A47804	–
ATV930D55N4Z...D90N4Z	VW3A47805	–

(1) These values are given for use in continuous operation with a nominal switching frequency of 4 kHz (ATV930U07N4Z...D45N4Z).

The switching frequency is adjustable from 2...12 kHz (ATV930U07N4Z...D45N4Z).

Above the nominal switching frequency, the drive will automatically reduce it in the event of an excessive temperature rise.

For continuous operation above the nominal switching frequency, nominal drive current should be derated according to the derating curves available on www.schneider-electric.com.

(2) Typical value for the indicated motor power and for the maximum prospective line Isc.

(3) Values given for applications requiring a slight overload (up to 120%).

(4) Values given for applications requiring a significant overload (up to 150%).

(5) These drives are IP 00 at bottom terminals for power connection.

Note: Consult the summary tables of possible drive, option, and accessory combinations (see [page 2/18](#)).

Variable speed drives

Altivar process ATV900

Three-phase supply voltage: 400 V 50/60 Hz

Modular single drives

ATVPro_62317_CPSSCT17006



ATV9A0C16Q4

3

400 V (- 15...10%) IP00 Modular standard single drives ⁽¹⁾								
Motor			Line supply			Altivar Process		
Power indicated on rating plate ⁽²⁾			Line current ⁽³⁾	Apparent power	Maximum prospective line Isc	Maximum continuous current ⁽²⁾	Max. transient current for 60 s	Reference ⁽⁴⁾
			400 V	400 V				
ND:	Normal duty							
HD:	Heavy duty							
	kW	HP	A	kVA	kA	A	A	
Altivar Process Modular for demanding applications								
THDi ≤ 48% at 100% load in Normal duty								
ND	110	–	198	135	50	211	253	ATV9A0C11Q4
HD	90	–	167	114	50	173	260	
ND	132	–	233	161	50	250	300	ATV9A0C13Q4
HD	110	–	198	136	50	211	317	
ND	160	–	278	192	50	302	362	ATV9A0C16Q4
HD	132	–	233	161	50	250	375	
ND	200	–	352	242	50	370	444	ATV9A0C20Q4
HD	160	–	290	198	50	302	453	
ND	250	–	432	299	50	477	572	ATV9A0C25Q4
HD	200	–	353	245	50	370	555	
ND	315	–	538	373	50	590	708	ATV9A0C31Q4
HD	250	–	432	299	50	477	716	
ND	355	–	611	423	50	660	792	ATV9A0C35Q4
HD	280	–	489	339	50	520	780	
ND	400	–	681	472	50	730	876	ATV9A0C40Q4
HD	315	–	545	378	50	590	885	
ND	450	–	764	529	50	830	996	ATV9A0C45Q4
HD	355	–	611	423	50	660	990	
ND	500	–	846	586	50	900	1080	ATV9A0C50Q4
HD	400	–	681	472	50	730	1095	
ND	560	–	948	657	50	1020	1224	ATV9A0C56Q4
HD	450	–	767	531	50	830	1245	
ND	630	–	1058	733	50	1140	1368	ATV9A0C63Q4
HD	500	–	849	588	50	900	1350	
ND	710	–	1192	826	50	1260	1512	ATV9A0C71Q4
HD	560	–	951	659	50	1020	1530	
ND	800	–	1335	925	50	1420	1704	ATV9A0C80Q4
HD	630	–	1061	735	50	1140	1710	

(1) Integrated motor chokes allowing a shielded motor cable length up to 300 m/984 ft in category C3.

(2) These values are given for a nominal switching frequency of 2.5 kHz for use in continuous operation.

The switching frequency is adjustable from 2 to 4.9 kHz for all ratings.

Above 2.5 kHz, the drive will automatically reduce the switching frequency in the event of an excessive temperature rise.

For continuous operation above the nominal switching frequency, derate the nominal drive current (see the derating curves on our website www.schneider-electric.com).

(3) Typical value for the indicated motor power and for the maximum prospective line Isc.

(4) These references are built by combining sub-assemblies and accessories that are integrated by Altivar Process Modular Program members. Please refer to the combination table (see [page 2/18](#)) for more information on possible single drive architectures.

Variable speed drives

Altivar process ATV900

Three-phase supply voltage: 440 V 50/60 Hz

Modular single drives



ATV9A0C31R4



ATV9A0C40R4

440 V (- 15...10%) IP00 Modular standard single drives ⁽¹⁾								
Motor		Line supply			Altivar Process			
Power indicated on rating plate ⁽²⁾		Line current ⁽³⁾	Apparent power	Maximum prospective line I _{sc}	Maximum continuous current ⁽²⁾	Max. transient current for 60 s	Reference ⁽⁴⁾	
		440 V	440 V					
ND:	Normal duty							
HD:	Heavy duty							
	kW	HP	A	kVA	kA	A	A	
Altivar Process Modular for demanding applications								
THDi ≤ 48% at 100% load in Normal duty								
ND	110	–	183	136	50	211	253	ATV9A0C11R4
HD	90	–	155	115	50	173	260	
ND	132	–	214	162	50	250	300	ATV9A0C13R4
HD	110	–	183	138	50	211	317	
ND	160	–	255	194	50	302	362	ATV9A0C16R4
HD	132	–	214	162	50	250	375	
ND	160	–	325	245	50	370	444	ATV9A0C20R4
HD	160	–	269	201	50	302	453	
ND	250	–	396	302	50	477	572	ATV9A0C25R4
HD	200	–	325	248	50	370	555	
ND	315	–	493	376	50	590	708	ATV9A0C31R4
HD	250	–	396	302	50	477	716	
ND	355	–	559	426	50	660	792	ATV9A0C35R4
HD	280	–	450	343	50	520	780	
ND	400	–	623	475	50	730	876	ATV9A0C40R4
HD	315	–	501	382	50	590	885	
ND	450	–	697	531	50	830	996	ATV9A0C45R4
HD	355	–	559	426	50	660	990	
ND	500	–	771	588	50	900	1080	ATV9A0C50R4
HD	400	–	623	475	50	730	1095	
ND	560	–	865	659	50	1020	1224	ATV9A0C56R4
HD	450	–	703	536	50	830	1245	
ND	630	–	965	735	50	1140	1368	ATV9A0C63R4
HD	500	–	776	591	50	900	1350	
ND	710	–	1087	828	50	1260	1512	ATV9A0C71R4
HD	580	–	869	662	50	1020	1530	
ND	800	–	1216	927	50	1420	1704	ATV9A0C80R4
HD	630	–	968	738	50	1140	1710	

(1) Integrated motor chokes allowing a shielded motor cable length up to 300 m/984 ft in category C3.
 (2) These values are given for a nominal switching frequency of 2.5 kHz for use in continuous operation. The switching frequency is adjustable from 2 to 4.9 kHz for all ratings. Above 2.5 kHz, the drive will automatically reduce the switching frequency in the event of an excessive temperature rise. For continuous operation above the nominal switching frequency, derate the nominal drive current (see the derating curves on our website www.schneider-electric.com).
 (3) Typical value for the indicated motor power and for the maximum prospective line I_{sc}.
 (4) These references are built by combining sub-assemblies and accessories that are integrated by Altivar Process Modular Program members. Please refer to the combination table (see [page 2/18](#)) for more information on possible single drive architectures.



Variable speed drives

Altivar process ATV900

Three-phase supply voltage: 480 V 50/60 Hz

Modular single drives

ATVPro_62317_CPSC171010



ATV9A0C63T4

3

ATVPro_62317_CPSC171011



ATV9A0C80T4

480 V (- 15...10%) IP00 Modular standard single drives ⁽¹⁾

Motor		Line supply			Altivar Process		Reference ⁽⁴⁾	
Power indicated on rating plate ⁽²⁾		Line current ⁽³⁾	Apparent power	Maximum prospective line Isc	Maximum continuous current ⁽²⁾	Max. transient current for 60 s		
		480 V	480 V					
ND:	Normal duty							
HD:	Heavy duty							
	kW	HP	A	kVA	kA	A	A	
Altivar Process Modular for demanding applications								
THDi ≤ 48% at 100% load in Normal duty								
ND	–	150	168	138	50	211	253	ATV9A0C11T4
HD	–	125	145	118	50	173	260	
ND	–	200	218	180	50	250	300	ATV9A0C13T4
HD	–	150	168	140	50	211	317	
ND	–	250	268	223	50	302	362	ATV9A0C16T4
HD	–	200	218	180	50	250	375	
ND	–	300	328	271	50	370	444	ATV9A0C20T4
HD	–	250	280	230	50	302	453	
ND	–	400	427	355	50	477	572	ATV9A0C25T4
HD	–	300	328	273	50	370	555	
ND	–	500	528	439	50	590	708	ATV9A0C31T4
HD	–	400	427	355	50	477	716	
ND	–	550	586	487	50	660	792	ATV9A0C35T4
HD	–	450	486	404	50	520	780	
ND	–	600	634	527	50	730	876	ATV9A0C40T4
HD	–	500	536	446	50	590	885	
ND	–	650	685	569	50	830	996	ATV9A0C45T4
HD	–	550	586	487	50	660	990	
ND	–	700	736	612	50	900	1080	ATV9A0C50T4
HD	–	600	634	527	50	730	1095	
ND	–	800	842	700	50	1020	1224	ATV9A0C56T4
HD	–	650	690	574	50	830	1245	
ND	–	900	939	781	50	1140	1368	ATV9A0C63T4
HD	–	700	740	615	50	900	1350	
ND	–	1000	1044	868	50	1260	1512	ATV9A0C71T4
HD	–	800	846	703	50	1020	1530	
ND	–	1100	1146	953	50	1420	1704	ATV9A0C80T4
HD	–	900	942	783	50	1140	1710	

(1) Integrated motor chokes allowing a shielded motor cable length up to 300 m/984 ft in category C3.
 (2) These values are given for a nominal switching frequency of 2.5 kHz for use in continuous operation.
 The switching frequency is adjustable from 2 to 4.9 kHz for all ratings.
 Above 2.5 kHz, the drive will automatically reduce the switching frequency in the event of an excessive temperature rise.
 For continuous operation above the nominal switching frequency, derate the nominal drive current (see the derating curves on our website www.schneider-electric.com).
 (3) Typical value for the indicated motor power and for the maximum prospective line Isc.
 (4) These references are built by combining sub-assemblies and accessories that are integrated by Altivar Process Modular Program members. Please refer to the combination table (see [page 2/18](#)) for more information on possible single drive architectures.

Variable speed drives

Altivar process ATV900

Three-phase supply voltage: 500 V 50/60 Hz

Modular single drives

ATVPro_62317_CPSCCT17006



ATV9A0C11N6

ATVPro_62317_CPSCCT17008



ATV9A0C25N6

500 V (-15...10%) IP00 Modular standard single drives (1)								
Motor			Line supply			Altivar Process		
Power indicated on rating plate (2)			Line current (3)	Apparent power	Maximum prospective line Isc	Maximum continuous current (2)	Max. transient current for 60 s	Reference (4)
			500 V	500 V				
ND:	Normal duty							
HD:	Heavy duty							
	kW	HP	A	kVA	kA	A	A	
Altivar Process Modular for demanding applications								
THDi ≤ 48% at 100% load in Normal duty								
ND	75	–	110	95	50	125	150	ATV9A0C11N6
HD	55	–	83	72	50	105	158	
ND	90	–	129	112	50	145	174	ATV9A0C13N6
HD	75	–	110	95	50	125	188	
ND	110	–	154	133	50	175	210	ATV9A0C16N6
HD	90	–	129	112	50	145	218	
ND	132	–	183	158	50	215	258	ATV9A0C20N6
HD	110	–	154	133	50	175	263	
ND	160	–	225	195	50	275	330	ATV9A0C25N6
HD	132	–	190	165	50	215	323	
ND	220	–	303	262	50	340	408	ATV9A0C31N6
HD	160	–	225	195	50	275	413	
ND	280	–	380	329	50	425	510	ATV9A0C40N6
HD	220	–	303	262	50	340	510	
ND	355	–	484	419	50	520	624	ATV9A0C50N6
HD	280	–	385	333	50	425	638	
ND	450	–	607	526	50	650	780	ATV9A0C63N6
HD	355	–	484	419	50	520	780	
ND	560	–	756	655	50	830	996	ATV9A0C80N6
HD	450	–	610	528	50	650	975	
ND	710	–	954	826	50	1030	1236	ATV9A0M10N6
HD	560	–	758	656	50	830	1245	
ND	800	–	1070	927	50	1230	1476	ATV9A0M12N6
HD	710	–	954	826	50	1030	1545	

(1) Integrated motor chokes allowing a shielded motor cable length up to 300 m/984 ft in category C3.

(2) These values are given for a nominal switching frequency of 2.5 kHz for use in continuous operation.

The switching frequency is adjustable from 2 to 4.9 kHz for all ratings.

Above 2.5 kHz, the drive will automatically reduce the switching frequency in the event of an excessive temperature rise.

For continuous operation above the nominal switching frequency, derate the nominal drive current (see the derating curves on our website www.schneider-electric.com).

(3) Typical value for the indicated motor power and for the maximum prospective line Isc.

(4) These references are built by combining sub-assemblies and accessories that are integrated by Altivar Process Modular Program members. Please refer to the combination table (see [page 2/18](#)) for more information on possible single drive architectures.

Variable speed drives

Altivar process ATV900

Three-phase supply voltage: 600 V 50/60 Hz

Modular single drives



ATV9A0C50T6



ATV9A0C80T6

3

600 V (- 15...10%) IP00 Modular standard single drives ⁽¹⁾								
Motor		Line supply			Altivar Process			
Power indicated on rating plate ⁽²⁾		Line current ⁽³⁾	Apparent power	Maximum prospective line Isc ⁽⁴⁾	Maximum continuous current ⁽²⁾	Max. transient current for 60 s	Reference ⁽⁵⁾	
		600 V	600 V					
ND:	Normal duty							
HD:	Heavy duty							
	kW	HP	A	kVA	kA	A	A	
Altivar Process Modular for demanding applications								
THDi ≤ 48% at 100% load in Normal duty								
ND	–	125	112	116	50	125	150	ATV9A0C11T6
HD	–	100	92	96	50	105	158	
ND	–	150	131	136	50	145	174	ATV9A0C13T6
HD	–	125	112	116	50	125	188	
ND	–	175	152	158	50	175	210	ATV9A0C16T6
HD	–	150	131	136	50	145	218	
ND	–	200	172	179	50	215	258	ATV9A0C20T6
HD	–	175	152	158	50	175	263	
ND	–	250	218	227	50	275	330	ATV9A0C25T6
HD	–	200	179	186	50	215	323	
ND	–	350	298	310	50	340	408	ATV9A0C31T6
HD	–	250	218	227	50	275	413	
ND	–	450	379	394	50	425	510	ATV9A0C40T6
HD	–	350	298	310	50	340	510	
ND	–	550	464	482	50	520	624	ATV9A0C50T6
HD	–	450	383	398	50	425	638	
ND	–	650	544	565	50	650	780	ATV9A0C63T6
HD	–	550	464	482	50	520	780	
ND	–	800	670	696	50	830	996	ATV9A0C80T6
HD	–	650	547	568	50	650	975	
ND	–	1000	833	866	50	1030	1236	ATV9A0M10T6
HD	–	800	673	699	50	830	1245	
ND	–	1200	994	1033	50	1230	1476	ATV9A0M12T6
HD	–	1000	835	835	50	1030	1545	

- (1) Integrated motor chokes allowing a shielded motor cable length up to 300 m/984 ft in category C3.
- (2) These values are given for a nominal switching frequency of 2.5 kHz for use in continuous operation.
The switching frequency is adjustable from 2 to 4.9 kHz for all ratings.
Above 2.5 kHz, the drive will automatically reduce the switching frequency in the event of an excessive temperature rise.
For continuous operation above the nominal switching frequency, derate the nominal drive current (see the derating curves on our website www.schneider-electric.com).
- (3) Typical value for the indicated motor power and for the maximum prospective line Isc.
- (4) For 600V UL certified drives, a higher SCCR is possible under some conditions. Please refer to the Integration Manual for more details.
- (5) These references are built by combining sub-assemblies and accessories that are integrated by Altivar Process Modular Program members. Please refer to the combination table (see [page 2/18](#)) for more information on possible single drive architectures.

Variable speed drives

Altivar process ATV900

Three-phase supply voltage: 690 V 50/60 Hz

Modular single drives

ATVPro_62317_CPSCT17011



ATV9A0M10Q6

ATVPro_CP19322



ATV9A0M12Q6

690 V (- 15...10%) IP00 Modular standard single drives (1)

Motor		Line supply			Altivar Process		
Power indicated on rating plate (2)		Line current (3)	Apparent power	Maximum prospective line Isc	Maximum continuous current (2)	Max. transient current for 60 s	Reference (4)
		690 V	690 V				
ND:	Normal duty						
HD:	Heavy duty						
	kW	HP	A	kVA	kA	A	A

Altivar Process Modular for demanding applications

THDi ≤ 48% at 100% load in Normal duty

ND	110	–	118	141	50	125	150	ATV9A0C11Q6
HD	90	–	100	120	50	105	158	
ND	132	–	138	165	50	145	174	ATV9A0C13Q6
HD	110	–	118	141	50	125	188	
ND	160	–	163	195	50	175	210	ATV9A0C16Q6
HD	132	–	138	165	50	145	218	
ND	200	–	200	239	50	215	258	ATV9A0C20Q6
HD	160	–	163	195	50	175	263	
ND	250	–	255	305	50	275	330	ATV9A0C25Q6
HD	200	–	211	252	50	215	323	
ND	315	–	316	378	50	340	408	ATV9A0C31Q6
HD	250	–	255	305	50	275	413	
ND	400	–	394	471	50	425	510	ATV9A0C40Q6
HD	315	–	316	378	50	340	510	
ND	500	–	495	592	50	520	624	ATV9A0C50Q6
HD	400	–	401	479	50	425	638	
ND	630	–	615	735	50	650	780	ATV9A0C63Q6
HD	500	–	495	592	50	520	780	
ND	800	–	776	927	50	830	996	ATV9A0C80Q6
HD	630	–	619	740	50	650	975	
ND	1000	–	969	1158	50	1030	1236	ATV9A0M10Q6
HD	800	–	779	931	50	830	1245	
ND	1200	–	1161	1388	50	1230	1476	ATV9A0M12Q6
HD	1000	–	971	1160	50	1030	1545	

(1) Integrated motor chokes allowing a shielded motor cable length up to 300 m/984 ft in category C3.

(2) These values are given for a nominal switching frequency of 2.5 kHz for use in continuous operation.

The switching frequency is adjustable from 2 to 4.9 kHz for all ratings.

Above 2.5 kHz, the drive will automatically reduce the switching frequency in the event of an excessive temperature rise.

For continuous operation above the nominal switching frequency, derate the nominal drive current (see the derating curves on our website www.schneider-electric.com).

(3) Typical value for the indicated motor power and for the maximum prospective line Isc.

(4) These references are built by combining sub-assemblies and accessories that are integrated by Altivar Process Modular Program members. Please refer to the combination table (see [page 2/18](#)) for more information on possible single drive architectures.



Variable speed drives

Altivar process ATV900

Three-phase supply voltage: 500 V 50/60 Hz

Drives for cabinet integration



ATV9B0C11N6



ATV9B0C25N6

3

500 V (-15...10%) IP00 low harmonic/regen single drives ⁽¹⁾								
Motor		Line supply			Altivar Process			
Power indicated on rating plate ⁽²⁾		Line current ⁽³⁾	Apparent power	Maximum prospective line Isc	Maximum continuous current ⁽²⁾	Max. transient current for 60 s	Reference ⁽⁴⁾	
		500 V	500 V					
ND:	Normal duty							
HD:	Heavy duty							
	kW	HP	A	kVA	kA	A	A	
Altivar Process Modular for demanding applications								
THDi ≤ 5% at 100% load in Normal duty								
ND	75	–	98	85	50	125	150	ATV9B0C11N6
HD	55	–	72	62	50	105	158	
ND	90	–	117	101	50	145	174	ATV9B0C13N6
HD	75	–	98	85	50	125	188	
ND	110	–	141	122	50	175	210	ATV9B0C16N6
HD	90	–	117	101	50	145	218	
ND	132	–	169	146	50	215	258	ATV9B0C20N6
HD	110	–	141	122	50	175	263	
ND	160	–	204	176	50	275	330	ATV9B0C25N6
HD	132	–	169	146	50	215	323	
ND	220	–	278	241	50	340	408	ATV9B0C31N6
HD	160	–	204	176	50	275	413	
ND	280	–	352	305	50	425	510	ATV9B0C40N6
HD	220	–	278	241	50	340	510	
ND	355	–	446	386	50	520	624	ATV9B0C50N6
HD	280	–	352	305	50	425	638	
ND	450	–	562	487	50	650	780	ATV9B0C63N6
HD	355	–	446	386	50	520	780	
ND	560	–	701	607	50	830	996	ATV9B0C80N6
HD	450	–	564	488	50	650	975	
ND	710	–	884	766	50	1030	1236	ATV9B0M10N6
HD	560	–	701	607	50	830	1245	
ND	800	–	991	859	50	1230	1476	ATV9B0M12N6
HD	710	–	884	766	50	1030	1545	

(1) Integrated motor chokes allowing a shielded motor cable length up to 300 m/984 ft in category C3.
 (2) These values are given for a nominal switching frequency of 2.5 kHz for use in continuous operation. The switching frequency is adjustable from 2 to 4.9 kHz for all ratings. Above 2.5 kHz, the drive will automatically reduce the switching frequency in the event of an excessive temperature rise. For continuous operation above the nominal switching frequency, derate the nominal drive current (see the derating curves on our website www.schneider-electric.com).
 (3) Typical value for the indicated motor power and for the maximum prospective line Isc.
 (4) These references are built by combining sub-assemblies and accessories that are integrated by Altivar Process Modular Program members. Please refer to the combination table (see [page 2/18](#)) for more information on possible single drive architectures.

Variable speed drives

Altivar process ATV900

Three-phase supply voltage: 600 V and 690 V 50/60 Hz

Drives for cabinet integration



ATV9B0C50T6



ATV9B0C80T6



ATV9B0M10Q6

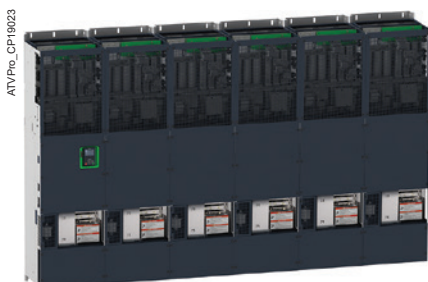

ATV9B0M12Q6

600 V (-15...10%) IP 00 low harmonic/regen single drives (continued) (1)

Motor	Line supply			Altivar Process				
	Power indicated on rating plate (2)	Line current (3)	Apparent power	Maximum prospective line Isc	Maximum continuous current (2)	Max. transient current for 60 s	Reference (5)	
ND: Normal duty	600 V	600 V						
HD: Heavy duty								
	kW	HP	A	kVA	kA	A	A	
Altivar Process Modular for demanding applications								
THDi ≤ 5% at 100% load in Normal duty								
ND	–	125	102	106	50	125	150	ATV9B0C11T6
HD	–	100	82	86	50	105	158	
ND	–	150	121	126	50	145	174	ATV9B0C13T6
HD	–	125	102	106	50	125	188	
ND	–	175	142	147	50	175	210	ATV9B0C16T6
HD	–	150	121	126	50	145	218	
ND	–	200	161	167	50	215	258	ATV9B0C20T6
HD	–	175	142	147	50	175	263	
ND	–	250	199	207	50	275	330	ATV9B0C25T6
HD	–	200	160	166	50	215	323	
ND	–	350	277	288	50	340	408	ATV9B0C31T6
HD	–	250	199	207	50	275	413	
ND	–	450	355	369	50	425	510	ATV9B0C40T6
HD	–	350	277	288	50	340	510	
ND	–	550	434	451	50	520	624	ATV9B0C50T6
HD	–	450	355	369	50	425	638	
ND	–	650	511	531	50	650	780	ATV9B0C63T6
HD	–	550	434	451	50	520	780	
ND	–	800	628	652	50	830	996	ATV9B0C80T6
HD	–	650	513	533	50	650	975	
ND	–	1000	785	815	50	1030	1236	ATV9B0M10T6
HD	–	800	628	652	50	830	1245	
ND	–	1200	937	973	50	1230	1476	ATV9B0M12T6
HD	–	1000	785	815	50	1030	1545	

690 V (-15...10%) IP 00 low harmonic/regen single drives (1)

Motor	Line supply			Altivar Process				
	Power indicated on rating plate (2)	Line current (3)	Apparent power	Maximum prospective line Isc	Maximum continuous current (2)	Max. transient current for 60 s	Reference (5)	
ND: Normal duty	690 V	690 V						
HD: Heavy duty								
	kW	HP	A	kVA	kA	A	A	
Altivar Process Modular for demanding applications								
THDi ≤ 5% at 100% load in Normal duty								
ND	110	–	102	122	50	125	150	ATV9B0C11Q6
HD	90	–	85	101	50	105	158	
ND	132	–	122	146	50	145	174	ATV9B0C13Q6
HD	110	–	102	122	50	125	188	
ND	160	–	148	177	50	175	210	ATV9B0C16Q6
HD	132	–	122	146	50	145	218	
ND	200	–	183	219	50	215	258	ATV9B0C20Q6
HD	160	–	148	177	50	175	263	
ND	250	–	228	273	50	275	330	ATV9B0C25Q6
HD	200	–	183	219	50	215	323	
ND	315	–	287	343	50	340	408	ATV9B0C31Q6
HD	250	–	228	273	50	275	413	
ND	400	–	363	434	50	425	510	ATV9B0C40Q6
HD	315	–	287	343	50	340	510	
ND	500	–	453	541	50	520	624	ATV9B0C50Q6
HD	400	–	362	433	50	425	638	
ND	630	–	568	678	50	650	780	ATV9B0C63Q6
HD	500	–	453	541	50	520	780	
ND	800	–	718	859	50	830	996	ATV9B0C80Q6
HD	630	–	569	680	50	650	975	
ND	1000	–	898	1073	50	1030	1236	ATV9B0M10Q6
HD	800	–	718	859	50	830	1245	
ND	1200	–	1078	1288	50	1230	1476	ATV9B0M12Q6
HD	1000	–	898	1073	50	1030	1545	

(1) Integrated motor chokes allowing a shielded motor cable length up to 300 m/984 ft in category C3.
 (2) These values are given for a nominal switching frequency of 2.5 kHz for use in continuous operation. The switching frequency is adjustable from 2 to 4.9 kHz for all ratings. Above 2.5 kHz, the drive will automatically reduce the switching frequency in the event of an excessive temperature rise. For continuous operation above the nominal switching frequency, derate the nominal drive current (see the derating curves on our website www.schneider-electric.com).
 (3) Typical value for the indicated motor power and for the maximum prospective line Isc.
 (4) For 600V UL certified drives, a higher SCCR is possible under some conditions. Please refer to the Integration Manual for more details.
 (5) These references are built by combining sub-assemblies and accessories that are integrated by Altivar Process Modular Program members. Please refer to the combination table (see page 2/18) for more information on possible single drive architectures.



Altivar Process Drive Systems

- [Altivar Process Drive Systems presentation..... page 4/2](#)
- [High Performance Drive Systems page 4/4](#)
- [Regenerative Drive Systems page 4/10](#)
- [Options page 4/16](#)
- [Dimensions page 4/20](#)

Variable speed drives

Altivar Process Drive Systems



ATV660C31Q4X1

4

Engineered Drive Systems

Altivar Process Drive Systems offer extensive flexibility for customers from different segments and for various applications.

Several solutions are available depending on customer requirements.

Configured to order (CTO)

In the CTO variant, Altivar Process Drive Systems can be quickly equipped via predefined CTO options to fit customer requirements.

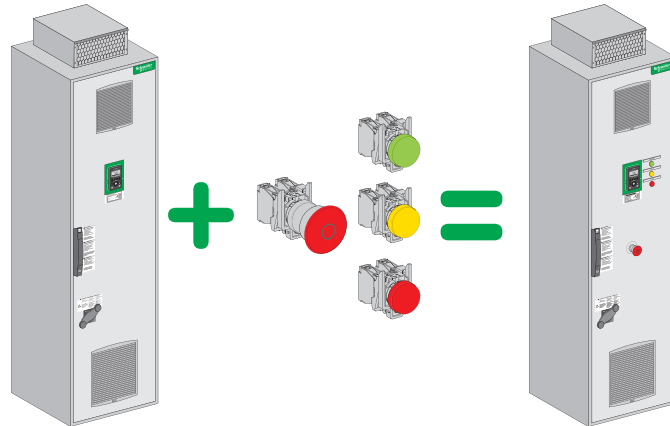

Thanks to its predefined CTO options, the CTO variant allows the minimum delivery time for individually adapted enclosures, ready to connect.

The available CTO options are:

- Increased IP 54 protection degree
- Enclosure plinth for basic device
- Additional enclosure allowing cabling from the top or from the bottom
- Enclosure lighting, heating
- "Local/remote" key switch
- Ethernet port on front door
- Digital and analog I/O modules and relay output modules
- Communication modules for various fieldbus systems
- STO - SIL 3 Stop category 0 or 1 emergency stop
- Front display module (FDM)
- Indicator lights on front door
- Motor/bearing temperature monitoring
- dv/dt filters for long motor cables
- Motor heating
- Circuit breaker
- Undervoltage coil for circuit breaker
- Motor for circuit breaker
- Automated mains disconnection
- Setting for 415 V + 10%
- Safety labels in the local language
- Design for IT mains
- Seaworthy packaging
- Braking Unit BUO



Engineered Drive System based on the
ATV660C50Q4X1 drive

Engineered Drive Systems (continued)

Engineered to order (ETO)

The ETO variant offers, in addition to the predefined CTO, the possibility of implementing customer-specific adaptations in Drive Systems.

The following adaptations are available:

- Modified wiring colors
- Remote monitoring
- Different ranges of supply voltages
- Multipulse supply (12-pulse)
- Design without a main switch
- Increased short-circuit strength up to 100 kA
- Air intake from the back
- Other enclosure colors
- Customized documentation and labeling
- Motor contactor
- Etc.



Full ETO Drive System

Full engineered to order (Full ETO)

With the Full ETO variant it is possible to design bespoke system solutions for the customer.

Typical design variations are:

- Multi-drive systems (several frequency inverters in the same enclosure)
- Other cooling systems
- Other enclosure types
- Other dimensions
- Etc.

For further information, please consult our [Customer Care Center](#).

Variable speed drives

Altivar Process ATV900

High Performance Drive Systems



ATV960C16Q4X1

4

Presentation

Concept

The ATV960 High Performance Drive Systems range offers standard enclosures ready to connect.

The modular system concept with more than 80 selectable options makes it possible to adapt the enclosure unit optimally to individual requirements.

The fully-tested, ready-to-connect enclosure allows quick installation and commissioning of the drive.

Power versus overload

For optimum adaptation to the application you can choose between two overload modes:

- Normal duty: High continuous power with an overload capability of 20% (for compressors, displacement pumps, blowers, etc.)
- Heavy duty: Reduced continuous power with an increased overload capability of 50% for 60 s for drives with enhanced requirements regarding overload capability, starting torque, load impacts, and control performance (such as mixers, crushers, mills, conveyors, etc.)

Standard equipment

The standard equipment contains frequency inverter modules, semiconductor fuses, a main switch, a line reactor to reduce the harmonics, a dv/dt filter choke (from 355 kW) to help protect the motor, and spacious mains and motor bars for connecting the power cables.

The design is based on the standard enclosure system "Spacial SF" with a graphic operating panel integrated into the enclosure door.

Compact dimensions

The control is located on a spacious control panel. It has compact dimensions, nevertheless there is enough space for additional extensions and accessibility in case of maintenance.

Variable speed drives

Altivar Process ATV900

High Performance Drive Systems

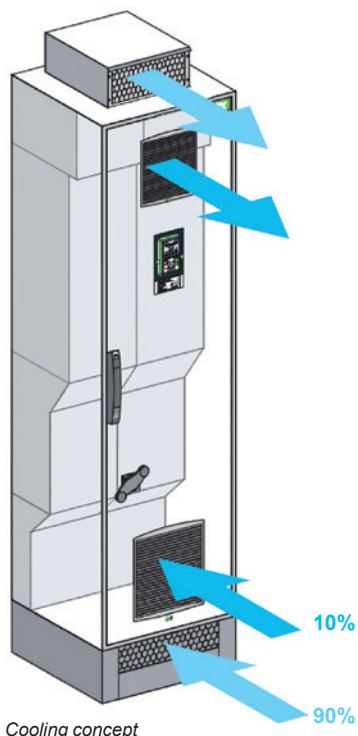

Device features

High motor performance

Optimum control over the motor in each operating state due to the new motor control method of the ATV960 High Performance Drive Systems.

- Asynchronous motors (all efficiency classes, high number of poles)
- Synchronous motors (PM motors, torque motors, reluctance motors)
- Special motors for submersible pumps

Extended connectivity

Integrated Dual Ethernet as standard provides increased redundancy and supports RSTP (Rapid Spanning Tree Protocol).

Dynamic drive-to-drive communication for multi-motor drives with master/slave groups and optimum load sharing between all motors.

Cooling concept

The power section components are cooled in a separate cooling air channel. About 90% of the heat losses are evacuated via this channel. The inside of the enclosure is cooled via fans in the enclosure door.

When using the "IP 54 increased protection degree" option, the separate air supply for the power section comes through the enclosure plinth.

Variable speed drives

Altivar Process ATV900

High Performance Drive Systems

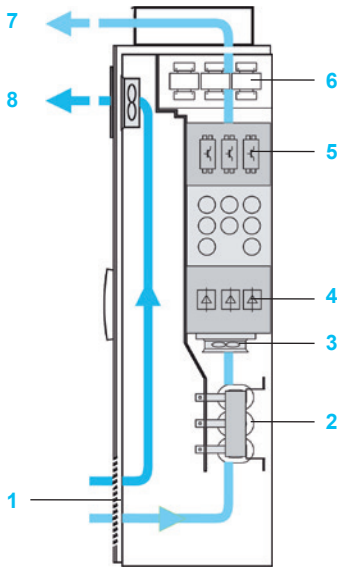

IP 23 enclosure

Protection degrees

The standard design of Altivar Process High Performance Drive Systems complies with the IP 23 protection degree. This solution provides optimum cooling of the built-in frequency inverter modules and power components as well as maximum compactness.

For operation in harsh ambient conditions, the increased IP 54 protection degree is available as an option. This solution consists of a clearly specified and tested cooling system with a separate cooling air channel which provides excellent reliability.

About 90% of the heat losses are evacuated via the separate cooling air channel. The inside of the enclosure is cooled via fans located in the enclosure door.

Standard IP 23 enclosure design

In order to avoid internal air short-circuits, the power sections of the components are located in the main cooling air channel.

The cooling air intake comes from a grid located in the bottom of the enclosure door. The internal fan, which is in a separate air channel, provides cooling of the power section. The air then comes out through the top of the enclosure.

The heat losses from the control section are evacuated by a fan in the enclosure door.

The incoming air temperature must be between 0 °C/32 °F and 40 °C/104 °F (-10 °C/14 °F with enclosure heating) and can reach +50 °C/122 °F with derating (class 3K3 according to IEC/EN 60721-3-3).

IP 23 enclosures comprise:

- 1 An air intake (without filter mat) via a grid on the bottom of the enclosure door
- 2 A line reactor
- 3 Fans for the power section
- 4 A rectifier module
- 5 An inverter module
- 6 A dv/dt filter choke
- 7 An air outlet via a metal cover with protection against water splashes on the enclosure roof
- 8 An air outlet (without filter mat) with fans for the control section

Increased IP 54 protection degree

With the increased IP 54 protection degree with separate channels, the cooling air intake comes from the floor and goes out through the enclosure roof.

The control section is cooled by filter fans located in the enclosure door.

The incoming air temperature must be between 0 °C/32 °F and 40 °C/104 °F (-10 °C/14 °F with enclosure heating) and can reach +50 °C/122 °F with derating (class 3K3 according to IEC/EN 60721-3-3).

IP 54 enclosures comprise:

- 9 An air intake for the power section via the enclosure plinth
- 10 A line reactor
- 11 Fans for the power section
- 12 A rectifier module
- 13 An inverter module
- 14 A dv/dt filter choke
- 15 An air outlet via a metal cover with protection against water splashes on the enclosure roof
- 16 An air outlet (with filter mat) with fans for the control section
- 17 An air intake grid (with filter mat) for the control section

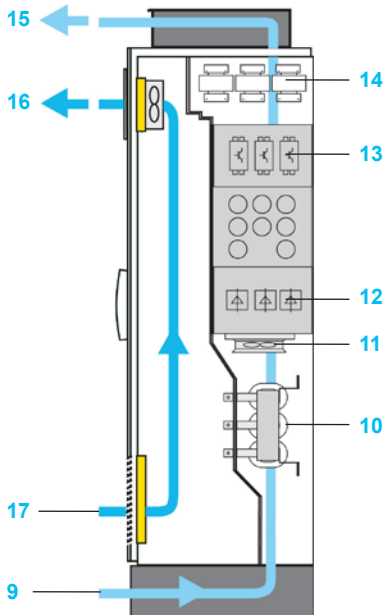

IP 54 enclosure

Variable speed drives

Altivar Process ATV900

High Performance Drive Systems



Additional enclosure allowing cabling from the bottom

Modular offer

This consists of:

- The standard High Performance offer
- One or more options (see [pages 4/16 to 4/19](#))

Options (CTO)

Some of these options depend on the drive rating. They can be integrated without any need for modifications to the enclosure:

- Increased IP 54 protection degree
- Enclosure plinth for basic device
- Additional enclosure allowing cabling from the top or from the bottom
- Enclosure lighting, heating
- "Local/remote" key switch
- Ethernet port on front door
- Digital and analog I/O modules and relay output modules
- Communication modules for various fieldbus systems
- Encoder interface modules
- STO - SIL 3 Stop category 0 or 1 emergency stop
- Front display module (FDM)
- Indicator lights on front door
- Motor/bearing temperature monitoring
- dv/dt filters for long motor cables
- Motor heating
- Circuit breaker
- Undervoltage coil for circuit breaker
- Motor for circuit breaker
- Automated mains disconnection
- Setting for 415 V + 10%
- Safety labels in the local language
- Braking Unit BUO

Further design variations (ETO)

These adaptations depend on the drive rating. Some may lead to modification of the size of the enclosure:

- Modified wiring colors
- Remote monitoring
- Different ranges of supply voltages
- Multipulse supply (12-pulse)
- Design without a main switch
- Increased short-circuit strength up to 100 kA
- Air intake from the back
- Other enclosure colors
- Customized documentation and labeling
- Motor contactor
- Etc.

Variable speed drives

Altivar Process ATV900

High Performance Drive Systems



ATV960C16Q4X1

4

IP 23 three-phase 380...415 V High Performance Drive Systems							
Motor	Line supply			Altivar Process		Reference (1)	Weight
	Power indicated on rating plate (1)	Line current (2)	Apparent power	Maximum prospective line Isc	Maximum continuous current (1)		
ND: Normal duty (3)	400 V			400 V			
HD: Heavy duty (4)							
kW	A	kVA	kA	A	A		kg/lb
THDi ≤ 44% at 100% load							
ND 110	195	135	50	211	253	ATV960C11Q4X1	300.000/ 661.386
HD 90	164	113	50	173	260		
ND 132	232	161	50	250	300	ATV960C13Q4X1	300.000/ 661.386
HD 110	197	136	50	211	317		
ND 160	277	192	50	302	362	ATV960C16Q4X1	300.000/ 661.386
HD 132	232	161	50	250	375		
ND 200	349	242	50	370	444	ATV960C20Q4X1	400.000/ 881.848
HD 160	286	198	50	302	453		
ND 250	432	299	50	477	572	ATV960C25Q4X1	400.000/ 881.848
HD 200	353	244	50	370	555		
ND 315	538	373	50	590	708	ATV960C31Q4X1	400.000/ 881.848
HD 250	432	299	50	477	716		
ND 355	611	423	50	660	792	ATV960C35Q4X1	650.000/ 1433.004
HD 280	489	339	50	520	780		
ND 400	681	472	50	730	876	ATV960C40Q4X1	650.000/ 1433.004
HD 315	545	378	50	590	885		
ND 450	764	529	50	830	996	ATV960C45Q4X1	650.000/ 1433.004
HD 355	611	423	50	660	990		
ND 500	846	586	50	900	1080	ATV960C50Q4X1	650.000/ 1433.004
HD 400	681	472	50	730	1095		
ND 560	948	656	50	1020	1224	ATV960C56Q4X1	850.000/ 1873.928
HD 450	767	531	50	830	1245		
ND 630	1058	733	50	1140	1368	ATV960C63Q4X1	850.000/ 1873.928
HD 500	849	588	50	900	1350		
ND 710	1192	826	50	1260	1512	ATV960C71Q4X1	1100.00/ 2425.083
HD 560	951	659	50	1020	1530		
ND 800	1335	925	50	1420	1704	ATV960C80Q4X1	1100.00/ 2425.083
HD 630	1061	735	50	1140	1710		

(1) These values are given for a nominal switching frequency of 2.5 kHz for use in continuous operation.

The switching frequency is adjustable from 2...8 kHz for all ratings.

Above 2.5 kHz, the drive will automatically reduce the switching frequency in the event of an excessive temperature rise. For continuous operation above the nominal switching frequency, derate the nominal drive current (see the derating curves on our website www.schneider-electric.com).

(2) Typical value for the indicated motor power and for the maximum prospective line Isc.

(3) Values given for applications requiring a slight overload (up to 120%).

(4) Values given for applications requiring a significant overload (up to 150% for 60 s).

Note: Consult the summary tables of possible drive, option, and accessory combinations (see [page 2/18](#)).

Variable speed drives

Altivar Process ATV900

High Performance Drive Systems



ATV960C35T4X1

IP 23 three-phase 480 V High Performance Drive Systems

Motor	Line supply			Altivar Process			Reference (1)	Weight
	Power indicated on rating plate (1)	Line current (2)	Apparent power	Maximum prospective line Isc	Maximum continuous current (1)	Maximum transient current for 60 s		
ND: Normal duty (3)	480 V							
HD: Heavy duty (4)								
kW	A	kVA	kA	A	A			kg/lb
THDi ≤ 44% at 100% load								
ND 132	196	163	50	211	253	ATV960C11T4X1	300.000/	661.386
HD 110	168	139	50	173	260			
ND 160	233	194	50	250	300	ATV960C13T4X1	300.000/	661.386
HD 132	198	164	50	211	317			
ND 180	258	194	50	302	362	ATV960C16T4X1	300.000/	661.386
HD 160	233	215	50	250	375			
ND 220	320	266	50	370	444	ATV960C20T4X1	400.000/	881.848
HD 180	267	222	50	302	453			
ND 280	400	333	50	477	572	ATV960C25T4X1	400.000/	881.848
HD 220	323	268	50	370	555			
ND 355	503	418	50	590	708	ATV960C31T4X1	400.000/	881.848
HD 280	400	333	50	477	716			
ND 400	572	475	50	660	792	ATV960C35T4X1	650.000/	1433.004
HD 315	456	379	50	520	780			
ND 450	637	530	50	730	876	ATV960C40T4X1	650.000/	1433.004
HD 355	510	424	50	590	885			
ND 500	706	587	50	830	996	ATV960C45T4X1	650.000/	1433.004
HD 400	572	475	50	660	990			
ND 560	789	656	50	900	1080	ATV960C50T4X1	650.000/	1433.004
HD 450	637	530	50	730	1095			
ND 630	888	739	50	1020	1224	ATV960C56T4X1	850.000/	1873.928
HD 500	711	591	50	830	1245			
ND 710	993	826	50	1140	1368	ATV960C63T4X1	850.000/	1873.928
HD 560	794	660	50	900	1350			
ND 800	1119	931	50	1260	1512	ATV960C71T4X1	1100.00/	2425.083
HD 630	893	742	50	1020	1530			
ND 900	1257	1045	50	1420	1704	ATV960C80T4X1	1100.00/	2425.083
HD 710	997	828	50	1140	1710			

(1) These values are given for a nominal switching frequency of 2.5 kHz for use in continuous operation.

The switching frequency is adjustable from 2...8 kHz for all ratings.

Above 2.5 kHz, the drive will automatically reduce the switching frequency in the event of an excessive temperature rise. For continuous operation above the nominal switching frequency, derate the nominal drive current (see the derating curves on our website www.schneider-electric.com).

(2) Typical value for the indicated motor power and for the maximum prospective line Isc.

(3) Values given for applications requiring a slight overload (up to 120%).

(4) Values given for applications requiring a significant overload (up to 150% for 60 s).

Note: Consult the summary tables of possible drive, option, and accessory combinations (see [page 2/18](#)).

Variable speed drives

Altivar Process ATV900

Regenerative Drive Systems



ATV980C16Q4X1

4

Presentation

Concept

The ATV980 Regenerative Drive Systems help improve the efficiency by feeding back the drive energy to the mains.

Schneider Electric has developed a concept based on a 3-level technology that reduces the total current distortion factor (THDi) to a value below 5% and allows the full energy flow in both directions at the same time.

During the development of the enclosure system, special attention was paid to make installation and operation simple. The result is a ready-to-connect enclosure for drives for which generator operating states can occur. This provides a 4-quadrant drive solution with shock-free changes from motor operation to generator operation.

The modular system concept with more than 80 selectable options makes it possible to adapt the enclosure unit to individual requirements. The fully-tested, ready-to-connect enclosure allows quick installation and commissioning of the drive.

Standard equipment

The standard Regenerative offer contains 3-level active infeed modules as well as frequency inverter modules, filter components, semiconductor fuses, a main switch, a dv/dt filter choke (from 160 kW) helping to protect the motor, and spacious mains and motor bars for connecting the power cables.

The design is based on the ready-assembled Sarel "Spacial SF" enclosures with a graphic operating panel integrated in the enclosure door.

Inside the enclosure there is a spaciouly designed control panel with the control components. It has compact dimensions, nevertheless there is enough space for additional extensions and accessibility for maintenance.

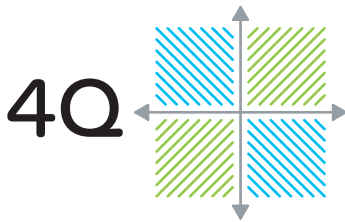

4-quadrant technology

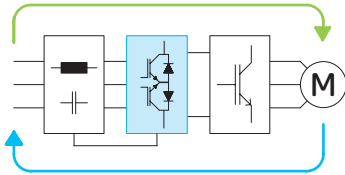

3-level technology

Device features

Simple use

ATV980 drives pilot and stop each motor without any additional effort. This 4-quadrant (4Q) technology is an ideal solution for drives for which generator operating states can occur. This avoids having complex multi-drive solutions.

Energy savings by highly efficient power regeneration

The 3-level technology inside the active mains rectifier and the dynamically adapted DC link voltage help ensure an efficient flow of energy to and from the mains. ATV980 Drive Systems therefore help save electrical energy.

Reduced load of the mains 3-level concept

In comparison with the classic circuit structure of active mains rectifiers, the 3-level technology allows the switching frequency to increase and the current load to be reduced at the same time.

This new technology achieves a total distortion factor (THDi) below 2% and thus fulfills the requirements of the IEEE 519 standard. The THDi is below 5% for distorted mains.

Additionally, the cosine Phi is equal to 1 in each load situation, helping to reduce the the load on the mains.

Variable speed drives

Altivar Process ATV900

Regenerative Drive Systems

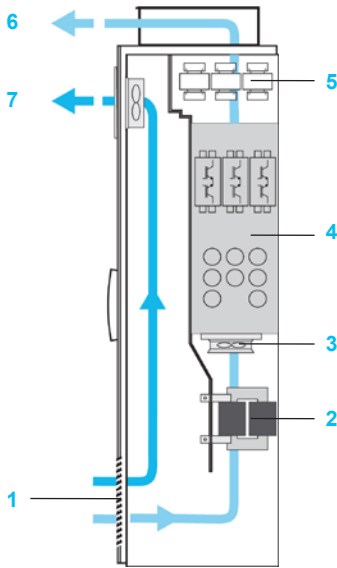

IP 23 enclosure

Protection degrees

The standard design of the Altivar Process Regenerative Drive Systems complies with the IP 23 protection degree. This solution provides optimal cooling of the built-in frequency inverter modules and power components as well as maximum compactness.

For operation with rough ambient conditions, the increased IP 54 protection degree is available as an option. This solution consists of a clearly specified and tested cooling system with a separate cooling air channel which provides good reliability.

About 90% of the heat losses are exhausted evacuated via the separate cooling air channel. The inside of the enclosure is cooled via fans located in the enclosure door.

Standard IP 23 enclosure design

In order to avoid internal air short-circuits, the power parts of the components are located in the main cooling air channel.

The cooling air intake comes from a grid located in the lower area of the enclosure door. The internal fan, which is in a separated air channel, provides the cooling of the power part. The air then comes out through the top of the enclosure.

The heat losses of the control part are exhausted by a fan in the enclosure door.

The incoming air temperature must be between 0 °C/32 °F and 40 °C/104 °F (-10 °C/14 °F with enclosure heating) and may reach +50 °C/122 °F with derating (class 3K3 according to IEC/EN 60721-3-3).

IP 23 enclosures comprise:

- 1 An air intake (without filter mat) via a grid on the lower part of the enclosure door
- 2 Filter components
- 3 Fans for the power part
- 4 An Active Front End module
- 5 A dv/dt filter choke
- 6 An air outlet via a metal cover with protection against water splashes on the enclosure roof
- 7 An air outlet (without filter mat) with fans for the control part

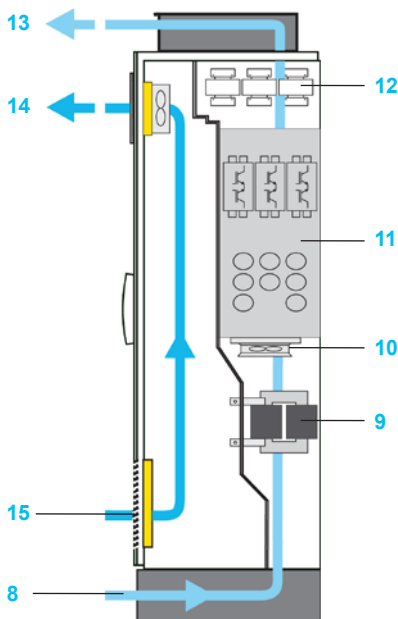

IP 54 enclosure

Increased IP 54 protection degree

With the increase IP 54 protection degree with separate channels the cooling air intake comes from the floor and goes out through the enclosure roof.

The control part is cooled by filter fans located in the enclosure door.

The incoming air temperature must be between 0 °C/32 °F and 40 °C/104 °F (-10 °C/14 °F with enclosure heating) and may reach +50 °C/122 °F with derating (class 3K3 according to IEC/EN 60721-3-3).

IP 54 enclosures comprise:

- 8 An air intake for the power part via the enclosure plinth
- 9 Filter components
- 10 Fans for the power part
- 11 An Active Front End module
- 12 A dv/dt filter choke
- 13 An air outlet via a metal cover with protection against water splashes on the enclosure roof
- 14 An air outlet (with filter mat) with fans for the control part
- 15 An air intake grid (with filter mat) for the control part



Enclosure heating

Modular offer

This consists of:

- The standard Regenerative offer
- One or more options (see [pages 4/16 to 4/19](#))

Options (CTO)

Some of these options depend on the drive rating. They can be integrated without any need for modifications to the enclosure:

- Increased IP 54 protection degree
- Enclosure plinth for basic device
- Additional enclosure allowing cabling from the top or from the bottom
- Enclosure lighting, heating
- "Local/remote" key switch
- Ethernet port on front door
- Digital and analog I/O modules and relay output modules
- Communication modules for various fieldbus systems
- Encoder interface modules
- STO - SIL 3 Stop category 0 or 1 emergency stop
- Front display module (FDM)
- Indicator lights on front door
- Motor/bearing temperature monitoring
- dv/dt filters for long motor cables
- Motor heating
- Circuit breaker
- Undervoltage coil for circuit breaker
- Motor for circuit breaker
- Automated mains disconnection
- Setting for 415 V + 10%
- Safety labels in the local language
- Braking Unit BUO

Further design variations (ETO)

These adaptations depend on the drive rating. Some may lead to modification of the size of the enclosure:

- Modified wiring colors
- Remote monitoring
- Different ranges of supply voltages
- Design without a main switch
- Increased short-circuit strength up to 100 kA
- Air intake from the back
- Other enclosure colors
- Customized documentation and labeling
- Motor contactor
- Etc.

Variable speed drives

Altivar Process ATV900

Regenerative Drive Systems



ATV980C31Q4X1

4

IP 23 three-phase 380...415 V Regenerative Drive Systems							
Motor	Line supply			Altivar Process			Weight
	Power indicated on rating plate (1)	Line current (2)	Apparent power	Maximum prospective line Isc	Maximum continuous current (1)	Maximum transient current for 60 s	
ND: Normal duty (3)	400 V	400 V					
HD: Heavy duty (4)							
kW	A	kVA	kA	A	A		kg/lb
THDi ≤ 5% at 100% load							
ND 110	175	121	50	211	253	ATV980C11Q4X1	400.000/881.848
HD 90	144	100	50	173	260		
ND 132	208	144	50	250	300	ATV980C13Q4X1	400.000/881.848
HD 110	174	121	50	211	317		
ND 160	252	174	50	302	362	ATV980C16Q4X1	400.000/881.848
HD 132	208	144	50	250	375		
ND 200	313	217	50	370	444	ATV980C20Q4X1	700.000/1543.235
HD 160	252	174	50	302	453		
ND 250	389	270	50	477	572	ATV980C25Q4X1	700.000/1543.235
HD 200	313	217	50	370	555		
ND 315	491	340	50	590	708	ATV980C31Q4X1	700.000/1543.235
HD 250	389	270	50	477	716		
ND 355	553	383	50	660	792	ATV980C35Q4X1	1150.000/2535.314
HD 280	436	302	50	520	780		
ND 400	620	429	50	730	876	ATV980C40Q4X1	1150.000/2535.314
HD 315	491	340	50	590	885		
ND 450	697	483	50	830	996	ATV980C45Q4X1	1150.000/2535.314
HD 355	553	383	50	660	990		
ND 500	775	537	50	900	1080	ATV980C50Q4X1	1150.000/2535.314
HD 400	620	429	50	730	1095		
ND 560	868	601	50	1020	1224	ATV980C56Q4X1	1450.000/3196.700
HD 450	697	483	50	830	1245		
ND 630	971	673	50	1140	1368	ATV980C63Q4X1	1450.000/3196.700
HD 500	775	537	50	900	1350		
ND 710	1094	758	50	1260	1512	ATV980C71Q4X1	1950.000/4299.011
HD 560	868	601	50	1020	1530		
ND 800	1227	850	50	1420	1704	ATV980C80Q4X1	1950.000/4299.011
HD 630	971	673	50	1140	1710		

(1) These values are given for a nominal switching frequency of 2.5 kHz for use in continuous operation.

The switching frequency is adjustable from 2...8 kHz for all ratings.

Above 2.5 kHz, the drive will automatically reduce the switching frequency in the event of an excessive temperature rise. For continuous operation above the nominal switching frequency, derate the nominal drive current (see the derating curves on our website www.schneider-electric.com).

(2) Typical value for the indicated motor power and for the maximum prospective line Isc.

(3) Values given for applications requiring a slight overload (up to 120%).

(4) Values given for applications requiring a significant overload (up to 150% for 60 s).

Note: Consult the summary tables of possible drive, option, and accessory combinations (see [page 4/16](#)).

Variable speed drives

Altivar Process ATV900

Regenerative Drive Systems



ATV980C35T4X1

IP 23 three-phase 480 V Regenerative Drive Systems

Motor	Line supply			Altivar Process			Reference (1)	Weight
	Power indicated on rating plate (1)	Line current (2)	Apparent power	Maximum prospective line Isc	Maximum continuous current (1)	Maximum transient current for 60 s		
	480 V	480 V						
ND: Normal duty (3)								
HD: Heavy duty (4)								
kW	A	kVA	kA	A	A			kg/lb
THDi ≤ 5% at 100% load								
ND 132	175	145	50	211	253	ATV980C11T4X1		400.000/881.848
HD 110	147	123	50	173	260			
ND 160	211	175	50	250	300	ATV980C13T4X1		400.000/881.848
HD 132	175	145	50	211	317			
ND 180	236	196	50	302	362	ATV980C16T4X1		400.000/881.848
HD 160	211	175	50	250	375			
ND 220	287	239	50	370	444	ATV980C20T4X1		700.000/1543.235
HD 180	236	196	50	302	453			
ND 280	363	302	50	477	572	ATV980C25T4X1		700.000/1543.235
HD 220	287	239	50	370	555			
ND 355	461	383	50	590	708	ATV980C31T4X1		700.000/1543.235
HD 280	363	302	50	477	716			
ND 400	519	432	50	660	792	ATV980C35T4X1		1150.000/2535.314
HD 315	409	340	50	520	780			
ND 450	581	483	50	730	876	ATV980C40T4X1		1150.000/2535.314
HD 355	461	383	50	590	885			
ND 500	646	537	50	830	996	ATV980C45T4X1		1150.000/2535.314
HD 400	519	432	50	660	990			
ND 560	723	601	50	900	1080	ATV980C50T4X1		1150.000/2535.314
HD 450	581	483	50	730	1095			
ND 630	813	676	50	1020	1224	ATV980C56T4X1		1450.000/3196.700
HD 500	646	537	50	830	1245			
ND 710	912	758	50	1140	1368	ATV980C63T4X1		1450.000/3196.700
HD 560	723	601	50	900	1350			
ND 800	1028	854	50	1260	1512	ATV980C71T4X1		1950.000/4299.011
HD 630	813	676	50	1020	1530			
ND 900	1150	956	50	1420	1704	ATV980C80T4X1		1950.000/4299.011
HD 710	912	758	50	1140	1710			

(1) These values are given for a nominal switching frequency of 2.5 kHz for use in continuous operation.

The switching frequency is adjustable from 2...8 kHz for all ratings.

Above 2.5 kHz, the drive will automatically reduce the switching frequency in the event of an excessive temperature rise. For continuous operation above the nominal switching frequency, derate the nominal drive current (see the derating curves on our website www.schneider-electric.com).

(2) Typical value for the indicated motor power and for the maximum prospective line Isc.

(3) Values given for applications requiring a slight overload (up to 120%).

(4) Values given for applications requiring a significant overload (up to 150% for 60 s).

Note: Consult the summary tables of possible drive, option, and accessory combinations (see [page 4/16](#)).

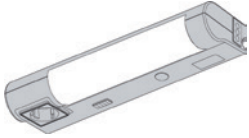

VW3AP1601

Common options (1)

Description	Reference	Weight kg/lb
Enclosure options		
Enclosure lighting (2)	VW3AP1601	0.500/ 1.102
Control options		
“Local/remote” key switch	VW3AP1801	0.200/ 0.441
Ethernet port on front door	VW3AP1807	0.200/ 0.441
I/O expansion modules		
Expansion module with additional I/O	VW3AP3203	0.200/ 0.441
Expansion module with relay outputs	VW3AP3204	0.200/ 0.441
Communication modules		
Profibus DP fieldbus module	VW3AP3607	0.200/ 0.441
CANopen Daisy Chain fieldbus module	VW3AP3608	0.200/ 0.441
DeviceNet fieldbus module	VW3AP3609	0.200/ 0.441
CANopen SUB-D9 fieldbus module	VW3AP3618	0.200/ 0.441
CANopen fieldbus module with screw terminals	VW3AP3628	0.200/ 0.441
PROFINET fieldbus module	VW3AP3627	0.200/ 0.441
EtherCAT Daisy Chain fieldbus module	VW3AP3601	0.200/ 0.441
Encoder interface modules		
Digital encoder interface module 5/12 V	VW3AP3420	0.150/ 0.331
Analog encoder interface module	VW3AP3422	0.150/ 0.331
Resolver encoder interface module	VW3AP3423	0.150/ 0.331
HTL encoder interface module	VW3AP3424	0.150/ 0.331
Safety functions		
Safe Torque Off STO - SIL 3 Stop category 0	VW3AP1502	0.200/ 0.441
Safe Torque Off STO - SIL 3 Stop category 1	VW3AP1503	0.500/ 1.102
Display options		
Indicator lights on front door	VW3AP0421	0.200/ 0.441
Motor options		
PTC relay for motor monitoring	VW3AP2001	0.200/ 0.441
PTC relay with ATEX certification for motor monitoring (3)	VW3AP2002	0.200/ 0.441
PT100/1000/KTY relay for motor monitoring	VW3AP2003	0.200/ 0.441
PT100/1000/KTY relay for bearing monitoring	VW3AP2004	0.200/ 0.441
Motor heating	VW3AP2101	0.300/ 0.661
Line supply		
Setting for 415 V + 10%	VW3AP0415	–
Ready for IT mains	VW3AP2701	–
Safety labels (4)		
English and German safety labels	VW3AP0561	–
English and Italian safety labels	VW3AP0562	–
English and Spanish safety labels	VW3AP0563	–
English and Dutch safety labels	VW3AP0564	–
English and Chinese safety labels	VW3AP0565	–
English and Russian safety labels	VW3AP0566	–
English and Turkish safety labels	VW3AP0567	–
English and Polish safety labels	VW3AP0568	–
English and Portuguese safety labels	VW3AP0569	–



VW3AP1502



Safety label

(1) These options cannot be ordered alone. For any other configuration, please contact our [Customer Care Center](#).

(2) Not available for ATV960C11●4X1...C16●4X1.

(3) ATEX: please refer to the ATEX guide available on our website www.schneider-electric.com.

(4) English and French as standards

Variable speed drives

Altivar Process ATV900

Drive Systems

CTO options dependent on the drive rating



VW3AP0801

Options dependent on the drive rating (1)			
Description	For enclosure (2)	Reference	Weight kg/lb
Enclosure options			
Enclosure heating	ATV960C11●4X1...C16●4X1	VW3AP0501	1.500/ 3.307
	ATV960C20●4X1...C50●4X1	VW3AP0502	3.000/ 6.614
	ATV960C56●4X1...C80●4X1	VW3AP0503	4.500/ 9.921
	ATV980C11●4X1...C31●4X1	VW3AP0551	2.000/ 4.409
	ATV980C35●4X1...C80●4X1	VW3AP0552	3.000/ 6.614
Increased IP 54 protection degree	ATV960C11●4X1...C16●4X1	VW3AP0301	13.000/ 28.660
	ATV960C20●4X1...C31●4X1	VW3AP0302	16.000/ 35.274
	ATV960C35●4X1...C50●4X1	VW3AP0303	19.000/ 41.888
	ATV960C56●4X1...C63●4X1	VW3AP0304	32.000/ 70.548
	ATV960C71●4X1...C80●4X1	VW3AP0305	35.000/ 77.162
	ATV980C11●4X1...C16●4X1	VW3AP0351	16.000/ 35.274
	ATV980C20●4X1...C31●4X1	VW3AP0352	29.000/ 63.934
	ATV980C35●4X1...C50●4X1	VW3AP0353	45.000/ 99.208
	ATV980C56●4X1...C63●4X1	VW3AP0354	58.000/ 127.668
	ATV980C71●4X1...C80●4X1	VW3AP0355	74.000/ 163.142
Enclosure plinth for basic device	ATV960C11●4X1...C16●4X1	VW3AP0801	9.000/ 19.842
	ATV960C20●4X1...C31●4X1	VW3AP0802	11.000/ 24.251
	ATV960C35●4X1...C50●4X1	VW3AP0803	13.000/ 28.660
	ATV960C56●4X1...C63●4X1	VW3AP0804	22.000/ 48.502
	ATV960C71●4X1...C80●4X1	VW3AP0805	24.000/ 52.911
	ATV980C11●4X1...C16●4X1	VW3AP0851	11.000/ 24.251
	ATV980C20●4X1...C31●4X1	VW3AP0852	20.000/ 44.093
	ATV980C35●4X1...C50●4X1	VW3AP0853	31.000/ 68.343
	ATV980C56●4X1...C63●4X1	VW3AP0854	40.000/ 88.185
	ATV980C71●4X1...C80●4X1	VW3AP0855	54.000/ 119.050

(1) These options cannot be ordered alone. For any other configuration, please contact our [Customer Care Center](#).

(2) Replace ● with Q for 380...415 V mains voltage or with T for 480 V mains voltage

Variable speed drives

Altivar Process ATV900

Drive Systems

CTO options dependent on the drive rating



VW3AP0707

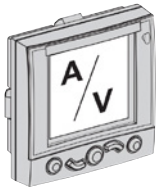

VW3AP0403

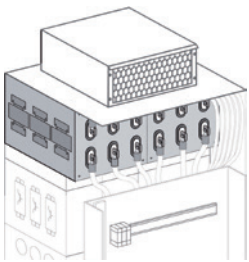

VW3AP0612

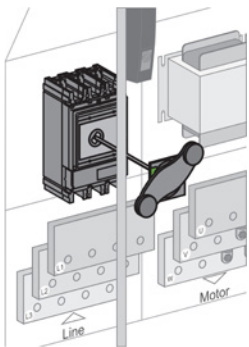

VW3AP0104

Options dependent on the drive rating (continued) (1)

Description	For enclosure (2)	Reference	Weight kg/lb	
Enclosure options				
Additional enclosure allowing cabling from the top	ATV960C11●4X1...C31●4X1	VW3AP0701	85.000/ 187.393	
	ATV980C11●4X1...C31●4X1			
	ATV960C35●4X1...C80●4X1	VW3AP0702	100.000/ 220.462	
	ATV980C35●4X1...C80●4X1			
Additional enclosure allowing cabling from the top with plinth	ATV960C11●4X1...C31●4X1	VW3AP0704	94.000/ 207.234	
	ATV980C11●4X1...C31●4X1			
	ATV960C35●4X1...C80●4X1	VW3AP0705	111.000/ 244.713	
	ATV980C35●4X1...C80●4X1			
Additional enclosure allowing cabling from the bottom	ATV960C11●4X1...C31●4X1	VW3AP0707	85.000/ 187.393	
	ATV980C11●4X1...C31●4X1			
	ATV960C35●4X1...C80●4X1	VW3AP0708	100.000/ 220.462	
	ATV980C35●4X1...C80●4X1			
Additional enclosure allowing cabling from the bottom with plinth	ATV960C11●4X1...C31●4X1	VW3AP0710	94.000/ 207.234	
	ATV980C11●4X1...C31●4X1			
	ATV960C35●4X1...C80●4X1	VW3AP0711	111.000/ 244.713	
	ATV980C35●4X1...C80●4X1			
Display options				
Front display module (FDM)	ATV960C11●4X1...C13●4X1	VW3AP0401	0.500/ 1.102	
	ATV980C11●4X1...C13●4X1			
	ATV960C16●4X1...C20●4X1	VW3AP0402	0.500/ 1.102	
	ATV980C16●4X1...C20●4X1			
	ATV960C25●4X1...C31●4X1	VW3AP0403	0.500/ 1.102	
	ATV980C25●4X1...C31●4X1			
	ATV960C35●4X1...C50●4X1	VW3AP0404	0.500/ 1.102	
	ATV980C35●4X1...C50●4X1			
	ATV960C56●4X1...C80●4X1	VW3AP0405	0.500/ 1.102	
	ATV980C56●4X1...C80●4X1			
Motor options				
150 m/492.12 ft dv/dt filter choke	ATV960C11●4X1...C16●4X1	VW3AP0601	25.000/ 55.116	
	ATV980C11●4X1...C16●4X1			
	ATV960C20●4X1...C31●4X1	VW3AP0602	50.000/ 110.231	
300 m/984.25 ft dv/dt filter choke	ATV960C11●4X1...C16●4X1	VW3AP0611	28.000/ 61.729	
	ATV980C11●4X1...C16●4X1			
	ATV960C20●4X1...C31●4X1	VW3AP0612	56.000/ 123.459	
	ATV980C20●4X1...C31●4X1			
	ATV960C35●4X1...C50●4X1	VW3AP0613	84.000/ 185.188	
	ATV980C35●4X1...C50●4X1			
	ATV960C56●4X1...C63●4X1	VW3AP0614	112.000/ 246.918	
	ATV980C56●4X1...C63●4X1			
	ATV960C71●4X1...C80●4X1	VW3AP0615	140.000/ 308.647	
	ATV980C71●4X1...C80●4X1			
Line supply				
Circuit breaker	ATV960C11●4X1...C16●4X1	VW3AP0101	2.000/ 4.409	
	ATV980C11●4X1...C16●4X1			
	ATV960C20●4X1...C31●4X1	VW3AP0102	2.000/ 4.409	
	ATV980C20●4X1...C31●4X1			
	ATV960C35●4X1...C40●4X1	VW3AP0103	1.000/ 2.204	
	ATV980C35●4X1...C40●4X1			
	ATV960C45●4X1...C50●4X1	VW3AP0104	1.000/ 2.204	
	ATV980C45●4X1...C50●4X1			
	ATV960C56●4X1...C63●4X1	VW3AP0105	1.000/ 2.204	
	ATV980C56●4X1...C63●4X1			
	ATV960C71●4X1...C80●4X1	VW3AP0106	1.000/ 2.204	
	ATV980C71●4X1...C80●4X1			
	Circuit breaker with MicroLogic	ATV960C11●4X1...C16●4X1	VW3AP0111	2.000/ 4.409
		ATV980C11●4X1...C16●4X1		
		ATV960C20●4X1...C31●4X1	VW3AP0112	2.000/ 4.409
		ATV980C20●4X1...C31●4X1		
ATV960C35●4X1...C40●4X1		VW3AP0113	1.000/ 2.204	
ATV980C35●4X1...C40●4X1				
ATV960C45●4X1...C50●4X1		VW3AP0114	1.000/ 2.204	
ATV980C45●4X1...C50●4X1				
ATV960C56●4X1...C63●4X1		VW3AP0115	1.000/ 2.204	
ATV980C56●4X1...C63●4X1				
ATV960C71●4X1...C80●4X1		VW3AP0116	1.000/ 2.204	
ATV980C71●4X1...C80●4X1				
Undervoltage coil for circuit breaker 230 V	ATV960C11●4X1...C31●4X1	VW3AP0201	0.100/ 0.220	
	ATV980C11●4X1...C31●4X1			
	ATV960C35●4X1...C80●4X1	VW3AP0202	0.100/ 0.220	
ATV980C35●4X1...C80●4X1				

(1) These options cannot be ordered alone. For any other configuration, please contact our Customer Care Center.

(2) Replace ● with Q for 380...415 V mains voltage or with T for 480 V mains voltage

Options dependent on the drive rating (continued) (1)

Description	For enclosure (2)	Reference	Weight kg/lb
Line supply (continued)			
Motor for circuit breaker 230 V	ATV960C11●4X1...C31●4X1	VW3AP0251	4.000/ 8.818
	ATV980C11●4X1...C31●4X1		
	ATV960C35●4X1...C40●4X1	VW3AP0252	4.000/ 8.818
	ATV980C35●4X1...C40●4X1		
	ATV960C45●4X1...C50●4X1	VW3AP0253	7.000/ 15.432
	ATV980C45●4X1...C50●4X1		
	ATV960C56●4X1...C63●4X1	VW3AP0254	7.000/ 15.432
	ATV980C56●4X1...C63●4X1		
	ATV960C71●4X1...C80●4X1	VW3AP0255	7.000/ 15.432
	ATV980C71●4X1...C80●4X1		
Automatic disconnection of supply	ATV960C11●4X1...C16●4X1	VW3AP0271	0.500/ 1.102
	ATV960C20●4X1...C31●4X1	VW3AP0272	0.500/ 1.102
	ATV960C35●4X1...C40●4X1	VW3AP0273	0.500/ 1.102
	ATV960C45●4X1...C50●4X1	VW3AP0274	0.500/ 1.102
	ATV960C56●4X1...C63●4X1	VW3AP0275	0.500/ 1.102
	ATV960C71●4X1...C80●4X1	VW3AP0276	0.500/ 1.102
Packaging			
Seaworthy packaging	ATV960C11●4X1...C16●4X1	VW3AP0811	105.000/ 231.485
	ATV960C20●4X1...C31●4X1	VW3AP0812	124.000/ 273.373
	ATV960C35●4X1...C50●4X1	VW3AP0813	138.000/ 304.237
	ATV960C56●4X1...C63●4X1	VW3AP0815	192.000/ 423.287
	ATV960C71●4X1...C80●4X1	VW3AP0816	205.000/ 451.947
	ATV980C11●4X1...C16●4X1	VW3AP0812	124.000/ 273.373
	ATV980C20●4X1...C31●4X1	VW3AP0814	155.000/ 341.716
	ATV980C35●4X1...C50●4X1	VW3AP0817	225.000/ 496.040
	ATV980C56●4X1...C63●4X1	VW3AP0819	255.000/ 562.178
	ATV980C71●4X1...C80●4X1	VW3AP0821	352.000/ 776.027
Braking unit			
Braking Unit BUO (IP23)	ATV960C11●4X1...C16●4X1	VW3AP1101	260.000/ 573.202
	ATV980C11●4X1...C16●4X2		
	ATV960C20●4X1...C31●4X1	VW3AP1102	260.000/ 573.202
	ATV980C20●4X1...C31●4X2		
	ATV960C35●4X1...C50●4X1	VW3AP1103	510.000/ 1124.358
	ATV980C35●4X1...C50●4X2		
	ATV960C56●4X1...C63●4X1	VW3AP1104	510.000/ 1124.358
	ATV980C56●4X1...C63●4X2		
	ATV960C71●4X1...C80●4X1	VW3AP1105	510.000/ 1124.358
	ATV980C71●4X1...C80●4X2		
Braking Unit BUO (IP54 with plinth)	ATV960C11●4X1...C16●4X1	VW3AP1111	269.000/ 593.043
	ATV980C11●4X1...C16●4X2		
	ATV960C20●4X1...C31●4X1	VW3AP1112	269.000/ 593.043
	ATV980C20●4X1...C31●4X2		
	ATV960C35●4X1...C50●4X1	VW3AP1113	528.000/ 1164.041
	ATV980C35●4X1...C50●4X2		
	ATV960C56●4X1...C63●4X1	VW3AP1114	528.000/ 1164.041
	ATV980C56●4X1...C63●4X2		
	ATV960C71●4X1...C80●4X1	VW3AP1115	528.000/ 1164.041
	ATV980C71●4X1...C80●4X2		
Braking Unit BUO (IP23 with plinth)	ATV960C11●4X1...C16●4X1	VW3AP1121	269.000/ 593.043
	ATV980C11●4X1...C16●4X2		
	ATV960C20●4X1...C31●4X1	VW3AP1122	269.000/ 593.043
	ATV980C20●4X1...C31●4X2		
	ATV960C35●4X1...C50●4X1	VW3AP1123	528.000/ 1164.041
	ATV980C35●4X1...C50●4X2		
	ATV960C56●4X1...C63●4X1	VW3AP1124	528.000/ 1164.041
	ATV980C56●4X1...C63●4X2		
	ATV960C71●4X1...C80●4X1	VW3AP1125	528.000/ 1164.041
	ATV980C71●4X1...C80●4X2		

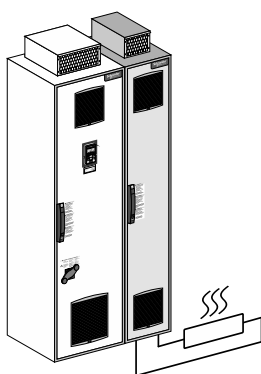
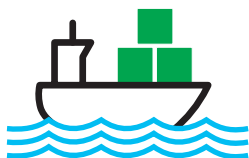

VW3AP1101

(1) These options cannot be ordered alone. For any other configuration, please contact our Customer Care Center.

(2) Replace ● with Q for 380...415 V mains voltage or with T for 480 V mains voltage.

Variable speed drives

Altivar process ATV900

IP 23 Drive Systems: 380...415 V



380...415 V Compact IP 23 Drive Systems

Overall dimensions

Drives	W x H x D (1)	
	mm	in.
ATV960C11Q4X1	400 x 2,150 x 664	15.75 x 84.65 x 26.14
ATV960C13Q4X1	400 x 2,150 x 664	15.75 x 84.65 x 26.14
ATV960C16Q4X1	400 x 2,150 x 664	15.75 x 84.65 x 26.14
ATV960C20Q4X1	600 x 2,150 x 664	23.62 x 84.65 x 26.14
ATV960C25Q4X1	600 x 2,150 x 664	23.62 x 84.65 x 26.14
ATV960C31Q4X1	600 x 2,150 x 664	23.62 x 84.65 x 26.14
ATV960C35Q4X1	800 x 2,150 x 664	31.50 x 84.65 x 26.14
ATV960C40Q4X1	800 x 2,150 x 664	31.50 x 84.65 x 26.14
ATV960C45Q4X1	800 x 2,150 x 664	31.50 x 84.65 x 26.14
ATV960C50Q4X1	800 x 2,150 x 664	31.50 x 84.65 x 26.14
ATV960C56Q4X1	1,200 x 2,150 x 664	47.24 x 84.65 x 26.14
ATV960C63Q4X1	1,200 x 2,150 x 664	47.24 x 84.65 x 26.14
ATV960C71Q4X1	1,400 x 2,150 x 664	55.12 x 84.65 x 26.14
ATV960C80Q4X1	1,400 x 2,150 x 664	55.12 x 84.65 x 26.14

(1) The total depth includes a door handle of 64 mm/2.54 in. The dimensions can differ depending on the chosen options. For further information, please contact our [Customer Care Center](#).



380...415 V Regenerative IP 23 Drive Systems

Overall dimensions

Drives	W x H x D (1)	
	mm	in.
ATV980C11Q4X1	600 x 2,150 x 664	23.62 x 84.65 x 26.14
ATV980C13Q4X1	600 x 2,150 x 664	23.62 x 84.65 x 26.14
ATV980C16Q4X1	600 x 2,150 x 664	23.62 x 84.65 x 26.14
ATV980C20Q4X1	1,000 x 2,150 x 664	39.37 x 84.65 x 26.14
ATV980C25Q4X1	1,000 x 2,150 x 664	39.37 x 84.65 x 26.14
ATV980C31Q4X1	1,000 x 2,150 x 664	39.37 x 84.65 x 26.14
ATV980C35Q4X1	1,600 x 2,150 x 664	62.99 x 84.65 x 26.14
ATV980C40Q4X1	1,600 x 2,150 x 664	62.99 x 84.65 x 26.14
ATV980C45Q4X1	1,600 x 2,150 x 664	62.99 x 84.65 x 26.14
ATV980C50Q4X1	1,600 x 2,150 x 664	62.99 x 84.65 x 26.14
ATV980C56Q4X1	2,000 x 2,150 x 664	78.74 x 84.65 x 26.14
ATV980C63Q4X1	2,000 x 2,150 x 664	78.74 x 84.65 x 26.14
ATV980C71Q4X1	2,600 x 2,150 x 664	102.36 x 84.65 x 26.14
ATV980C80Q4X1	2,600 x 2,150 x 664	102.36 x 84.65 x 26.14

(1) The total depth includes a door handle of 64 mm/2.54 in. The dimensions can differ depending on the chosen options. For further information, please contact our [Customer Care Center](#).



Services

- A whole world of services for your drives..... [page 5/2](#)

Index

- Product reference index..... [page 5/4](#)

Variable speed drives

Altivar Process

A whole world of services for your drives by Schneider Electric



Drives support and services offer by Schneider Electric

Variable speed drives are an important part of your operation, with downtime having a significant impact on your business. Helping to protect that investment through comprehensive drive services means that you can continue to deliver optimally throughout the lifecycle of your drive. Our range of services are designed to help you get more out of your drives – and your operation.

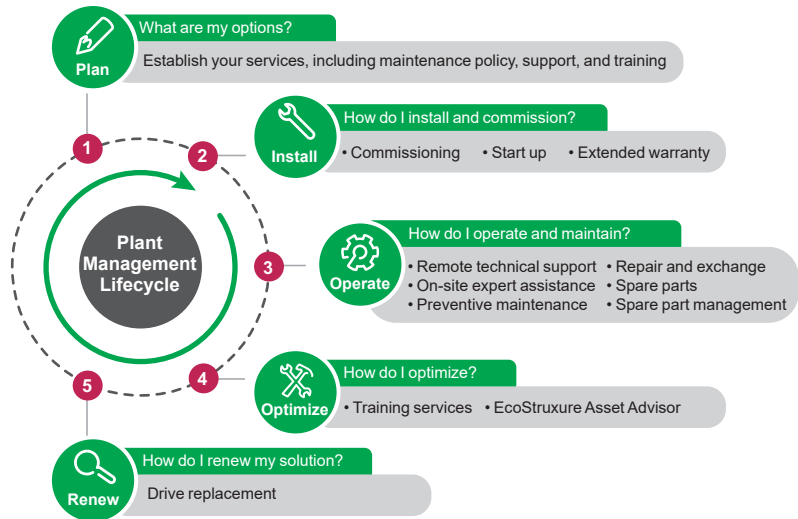

5



Install

- **Our Extended Warranty** service helps you to control your maintenance costs. In case of failure during the 3 or 5 year extended warranty period, Schneider Electric will send you a replacement drive or repair the drive on site.
- **Our Start-up** service is the first essential step in maintenance and optimal operational performance of the drive. Our comprehensive review checks up to 100 parameters and is specially designed for drives in simple applications.
- **Our Commissioning** service helps to ensure a reliable start for operations with more complex applications and drive systems. The unique requirements of your process need to be carefully considered to achieve efficient operations.

Operate

- **Our Preventive Maintenance** service performs predetermined maintenance actions according to the drive's specific operating schedule. The work is carried out by certified technical experts following Schneider Electric instructions. The service minimizes unplanned downtime and extends your equipment lifetime.
- **Remote Technical Support** provides expert assistance over phone, email, chat, or web on any technical query you have regarding configuring, diagnosing, and maintaining your drives. Our global support team is multi-lingual with support available up to R&D level experts if needed.
- **Our On-Site Expert Assistance** service provides highly skilled field service experts to troubleshoot and resolve any drive-related technical difficulties at your site, as expertise back-up for your personnel.
- **Our Repair and Exchange** service is available in case of failure. Defective drives can be replaced, repaired on-site or at our repair centers depending on the type of drive in question. The key target is to shorten your downtime.
- **Spare Parts** are available from our local, regional, and global stocks. Original equipment parts from Schneider Electric are reliable and easily available.
- **The Spare Part Management** service identifies and manages your critical spare parts either on your premises or offsite. This service helps to ensure your access to the spares without you needing to invest on capital to maintain the stock.



Variable speed drives

Altivar Process

A whole world of services for your drives by Schneider Electric



Drives support and services offer by Schneider Electric (continued)

Optimize

- **Our Training** service offers tailored eLearning, classroom, and on-site training sessions to provide your personnel with the necessary technical installation, commissioning, and maintenance skills. This enhanced expertise equates to greater process efficiency and reliability, as well as higher employee satisfaction.
- **Our EcoStruxure Asset Advisor** service enables you to move from reactive to predictive maintenance and access actionable insight provided by the advisor. The service predicts potential drive and motor failures through connected devices and advanced algorithms monitored by Schneider Electric's experts.

Renew

- **Drive replacement** means reliable modernization of equipment by replacing aging or obsolete drives with new ones specifically designed for the purpose. The service can be extended to include engineering in case the device and process requires more advanced engineering.

Service contracts help to secure recovery, availability, and outcome

A **service contract** helps to secure your assets and manage performance through well-defined maintenance plans tailored to your operational needs. The predefined service contract – Advantage Service Plan – and fully customizable “A la Carte” service contract are built from the services in the “Operate” and “Optimize” phases and service levels defining availability, response, and lead times matching your particular needs. You will enjoy priority access to Schneider Electric support when you need it, as well as having an expert partner to plan the long term evolution of your drives.

mySchneider app

The mySchneider app gives you easy 24/7 access to product information and expert support. All registered users have access to additional features, such as real-time notifications, order tracking, product pricing, and availability. The mySchneider app is available for download from the IOS and Android app store.

Schneider Electric – helping you succeed

Schneider Electric, the leader in digital transformation of energy management and automation, has operations in more than 100 countries. With this global footprint we have certified drives field service representatives, regional expert and advanced level support up to product R&D to provide you with a premium level of support across the lifecycle of your drives. Furthermore, we have an extensive network of local and global repair centers and logistics chain, so you can be sure of our capability to respond.

To order services or find out more, please contact your local Schneider Electric service center.

4									
490NTC00005	2/28	ATV9A0C50Q6	3/13	ATV9B0M12T6	3/15	ATV930U15N4	2/5	ATV960C11T4X1	4/9
490NTC00005U	2/28	ATV9A0C50R4	3/9	ATV930C11N4C	2/6	ATV930U15N4Z	3/6	ATV960C13Q4X1	4/8
490NTC00015	2/28	ATV9A0C50T4	3/10	ATV930C11N4F	2/10	ATV930U22M3	2/4	ATV960C13T4X1	4/9
490NTC00015U	2/28	ATV9A0C50T6	3/12	ATV930C13N4C	2/6	ATV930U22N4	2/5	ATV960C16Q4X1	4/8
490NTW00002	2/28	ATV9A0C56Q4	3/8	ATV930C13N4F	2/10	ATV930U22N4Z	3/6	ATV960C16T4X1	4/9
490NTW00002U	2/28	ATV9A0C56R4	3/9	ATV930C16N4C	2/6	ATV930U22Y6	2/9	ATV960C20Q4X1	4/8
490NTW00005	2/28	ATV9A0C56T4	3/10	ATV930C16N4F	2/10	ATV930U30M3	2/4	ATV960C20T4X1	4/9
490NTW00005U	2/28	ATV9A0C63N6	3/11	ATV930C20N4F	2/10	ATV930U30N4	2/5	ATV960C25Q4X1	4/8
490NTW00012	2/28	ATV9A0C63Q4	3/8	ATV930C22N4	2/5	ATV930U30N4Z	3/6	ATV960C25T4X1	4/9
490NTW00012U	2/28	ATV9A0C63Q6	3/13	ATV930C22N4C	2/6	ATV930U30Y6	2/9	ATV960C31Q4X1	4/8
		ATV9A0C63R4	3/9	ATV930C25N4C	2/6	ATV930U40M3	2/4	ATV960C31T4X1	4/9
		ATV9A0C63T4	3/10	ATV930C25N4F	2/10	ATV930U40N4	2/5	ATV960C35Q4X1	4/8
A		ATV9A0C63T6	3/12	ATV930C31N4C	2/6	ATV930U40N4Z	3/6	ATV960C35T4X1	4/9
ATV9A0C11N6	3/11	ATV9A0C71Q4	3/8	ATV930C31N4F	2/10	ATV930U40Y6	2/9	ATV960C40Q4X1	4/8
ATV9A0C11Q4	3/8	ATV9A0C71R4	3/9	ATV930D11M3	2/4	ATV930U55M3	2/4	ATV960C40T4X1	4/9
ATV9A0C11Q6	3/13	ATV9A0C71T4	3/10	ATV930D11N4	2/5	ATV930U55N4	2/5	ATV960C45Q4X1	4/8
ATV9A0C11R4	3/9	ATV9A0C80N6	3/11	ATV930D11N4Z	3/6	ATV930U55N4Z	3/6	ATV960C45T4X1	4/9
ATV9A0C11T4	3/10	ATV9A0C80Q4	3/8	ATV930D11Y6	2/9	ATV930U55Y6	2/9	ATV960C50Q4X1	4/8
ATV9A0C11T6	3/12	ATV9A0C80Q6	3/13	ATV930D15M3	2/4	ATV930U75M3	2/4	ATV960C50T4X1	4/9
ATV9A0C13N6	3/11	ATV9A0C80R4	3/9	ATV930D15N4	2/5	ATV930U75N4	2/5	ATV960C56Q4X1	4/8
ATV9A0C13Q4	3/8	ATV9A0C80T4	3/10	ATV930D15N4Z	3/6	ATV930U75N4Z	3/6	ATV960C56T4X1	4/9
ATV9A0C13Q6	3/13	ATV9A0C80T6	3/12	ATV930D15Y6	2/9	ATV930U75Y6	2/9	ATV960C63Q4X1	4/8
ATV9A0C13R4	3/9	ATV9A0M10N6	3/11	ATV930D18M3	2/4	ATV950C11N4F	2/11	ATV960C63T4X1	4/9
ATV9A0C13T4	3/10	ATV9A0M10Q6	3/13	ATV930D18N4	2/5	ATV950C13N4F	2/11	ATV960C71Q4X1	4/8
ATV9A0C13T6	3/12	ATV9A0M10T6	3/12	ATV930D18N4Z	3/6	ATV950C16N4F	2/11	ATV960C71T4X1	4/9
ATV9A0C16N6	3/11	ATV9A0M12N6	3/11	ATV930D18Y6	2/9	ATV950C20N4F	2/11	ATV960C80Q4X1	4/8
ATV9A0C16Q4	3/8	ATV9A0M12Q6	3/13	ATV930D22M3	2/4	ATV950C25N4F	2/11	ATV960C80T4X1	4/9
ATV9A0C16Q6	3/13	ATV9A0M12T6	3/12	ATV930D22N4	2/5	ATV950C31N4F	2/11	ATV980C11Q4X1	4/14
ATV9A0C16R4	3/9	ATV9B0C11N6	3/14	ATV930D22N4Z	3/6	ATV950D11N4	2/7	ATV980C11T4X1	4/15
ATV9A0C16T4	3/10	ATV9B0C11Q6	3/15	ATV930D22Y6	2/9	ATV950D11N4E	2/8	ATV980C13Q4X1	4/14
ATV9A0C16T6	3/12	ATV9B0C11T6	3/15	ATV930D30M3	2/4	ATV950D15N4	2/7	ATV980C13T4X1	4/15
ATV9A0C20N6	3/11	ATV9B0C13N6	3/14	ATV930D30M3C	2/4	ATV950D15N4E	2/8	ATV980C16Q4X1	4/14
ATV9A0C20Q4	3/8	ATV9B0C13Q6	3/15	ATV930D30N4	2/5	ATV950D18N4	2/7	ATV980C16T4X1	4/15
ATV9A0C20Q6	3/13	ATV9B0C13T6	3/15	ATV930D30N4Z	3/7	ATV950D18N4E	2/8	ATV980C20Q4X1	4/14
ATV9A0C20R4	3/9	ATV9B0C16N6	3/14	ATV930D30Y6	2/9	ATV950D22N4	2/7	ATV980C20T4X1	4/15
ATV9A0C20T4	3/10	ATV9B0C16Q6	3/15	ATV930D37M3	2/4	ATV950D22N4E	2/8	ATV980C25Q4X1	4/14
ATV9A0C20T6	3/12	ATV9B0C16T6	3/15	ATV930D37M3C	2/4	ATV950D30N4	2/7	ATV980C25T4X1	4/15
ATV9A0C25N6	3/11	ATV9B0C20N6	3/14	ATV930D37N4	2/5	ATV950D30N4E	2/8	ATV980C31Q4X1	4/14
ATV9A0C25Q4	3/8	ATV9B0C20Q6	3/15	ATV930D37N4Z	3/7	ATV950D37N4	2/7	ATV980C31T4X1	4/15
ATV9A0C25Q6	3/13	ATV9B0C20T6	3/15	ATV930D37Y6	2/9	ATV950D37N4E	2/8	ATV980C35Q4X1	4/14
ATV9A0C25R4	3/9	ATV9B0C25N6	3/14	ATV930D45M3	2/4	ATV950D45N4	2/7	ATV980C35T4X1	4/15
ATV9A0C25T4	3/10	ATV9B0C25Q6	3/15	ATV930D45M3C	2/4	ATV950D45N4E	2/8	ATV980C40Q4X1	4/14
ATV9A0C25T6	3/12	ATV9B0C25T6	3/15	ATV930D45N4	2/5	ATV950D55N4	2/7	ATV980C40T4X1	4/15
ATV9A0C31N6	3/11	ATV9B0C31N6	3/14	ATV930D45N4Z	3/7	ATV950D55N4E	2/8	ATV980C45Q4X1	4/14
ATV9A0C31Q4	3/8	ATV9B0C31Q6	3/15	ATV930D45Y6	2/9	ATV950D75N4	2/7	ATV980C45T4X1	4/15
ATV9A0C31Q6	3/13	ATV9B0C31T6	3/15	ATV930D55M3C	2/4	ATV950D75N4E	2/8	ATV980C50Q4X1	4/14
ATV9A0C31R4	3/9	ATV9B0C40N6	3/14	ATV930D55N4	2/5	ATV950D90N4	2/7	ATV980C50T4X1	4/15
ATV9A0C31T4	3/10	ATV9B0C40Q6	3/15	ATV930D55N4C	2/6	ATV950D90N4E	2/8	ATV980C56Q4X1	4/14
ATV9A0C31T6	3/12	ATV9B0C40T6	3/15	ATV930D55N4Z	3/7	ATV950U07N4	2/7	ATV980C56T4X1	4/15
ATV9A0C35Q4	3/8	ATV9B0C50N6	3/14	ATV930D55Y6	2/9	ATV950U07N4E	2/8	ATV980C63Q4X1	4/14
ATV9A0C35R4	3/9	ATV9B0C50Q6	3/15	ATV930D75M3C	2/4	ATV950U15N4	2/7	ATV980C63T4X1	4/15
ATV9A0C35T4	3/10	ATV9B0C50T6	3/15	ATV930D75N4	2/5	ATV950U15N4E	2/8	ATV980C71Q4X1	4/14
ATV9A0C40N6	3/11	ATV9B0C63N6	3/14	ATV930D75N4C	2/6	ATV950U22N4	2/7	ATV980C71T4X1	4/15
ATV9A0C40Q4	3/8	ATV9B0C63Q6	3/15	ATV930D75N4Z	3/7	ATV950U22N4E	2/8	ATV980C80Q4X1	4/14
ATV9A0C40Q6	3/13	ATV9B0C63T6	3/15	ATV930D75Y6	2/9	ATV950U30N4	2/7	ATV980C80T4X1	4/15
ATV9A0C40R4	3/9	ATV9B0C80N6	3/14	ATV930D90N4	2/5	ATV950U30N4E	2/8		
ATV9A0C40T4	3/10	ATV9B0C80Q6	3/15	ATV930D90N4C	2/6	ATV950U40N4	2/7	L	
ATV9A0C40T6	3/12	ATV9B0C80T6	3/15	ATV930D90N4Z	3/7	ATV950U40N4E	2/8	LU9AD7	2/31
ATV9A0C45Q4	3/8	ATV9B0M10N6	3/14	ATV930D90Y6	2/9	ATV950U55N4	2/7	LU9GC3	2/15
ATV9A0C45R4	3/9	ATV9B0M10Q6	3/15	ATV930U07M3	2/4	ATV950U55N4E	2/8		2/28
ATV9A0C45T4	3/10	ATV9B0M10T6	3/15	ATV930U07N4	2/5	ATV950U75N4	2/7	N	
ATV9A0C50N6	3/11	ATV9B0M12N6	3/14	ATV930U07N4Z	3/6	ATV950U75N4E	2/8	NSYAEPFPPTD	2/13
ATV9A0C50Q4	3/8	ATV9B0M12Q6	3/15	ATV930U15M3	2/4	ATV960C11Q4X1	4/8	NSYCAF223	2/12

NSYCAF291	2/12	VW3A4704	2/46	VW3A7735	2/34	VW3A9704	2/13	VW3A46164	2/45
NSYPTDS1	2/13		2/47		2/36	VW3A9705	2/13	VW3A46165	2/45
NSYPTDS2	2/13	VW3A4705	2/46	VW3A7736	2/34	VW3A9706	2/13	VW3A46166	2/45
NSYPTDS3	2/13		2/47		2/35	VW3A46101	2/40	VW3A46167	2/45
NSYPTDS4	2/13	VW3A4706	2/46	VW3A7737	2/34	VW3A46102	2/40	VW3A46168	2/45
NSYPTDS5	2/13		2/47		2/36	VW3A46103	2/40	VW3A46169	2/45
T		VW3A4707	2/46	VW3A7738	2/34	VW3A46104	2/40	VW3A46170	2/45
TCSCAR01NM120	2/30		2/47	VW3A7738	2/34	VW3A46105	2/40	VW3A46171	2/45
TCSCAR013M120	2/29	VW3A4708	2/46	VW3A7740	2/36	VW3A46106	2/40	VW3A46172	2/45
TCSEGWB13FA0	2/14		2/47		2/37	VW3A46107	2/40	VW3A46173	2/45
TSXCNCNAMUM3P	2/15	VW3A4709	2/46	VW3A7741	2/36	VW3A46108	2/40	VW3A46174	2/45
TSXCANCA50	2/29		2/47		2/37	VW3A46109	2/40	VW3A46176	2/45
TSXCANCA100	2/29	VW3A4710	2/46	VW3A7742	2/36	VW3A46110	2/40	VW3A47801	3/7
TSXCANCA300	2/29		2/47		2/37	VW3A46111	2/40	VW3A47802	3/7
TSXCANCADD1	2/30	VW3A5103	2/50	VW3A7743	2/36	VW3A46112	2/40	VW3A47803	3/7
TSXCANCADD03	2/30	VW3A5104	2/50		2/37	VW3A46113	2/40	VW3A47804	3/7
TSXCANCB50	2/29	VW3A5106	2/50	VW3A7743	2/36	VW3A46114	2/41	VW3A47805	3/7
TSXCANCB100	2/29	VW3A5107	2/50		2/37	VW3A46115	2/41	VW3A47901	2/47
TSXCANCB300	2/29	VW3A5209	2/53	VW3A7744	2/36	VW3A46116	2/41	VW3A47902	2/47
TSXCANCBDD3	2/30	VW3A5210	2/53		2/37	VW3A46118	2/41	VW3A47903	2/47
TSXCANCBDD5	2/30	VW3A5215	2/53	VW3A7745	2/36	VW3A46119	2/41	VW3A47904	2/47
TSXCANCD50	2/29	VW3A5216	2/53		2/37	VW3A46120	2/42	VW3A47905	2/47
TSXCANCD100	2/29	VW3A5217	2/53	VW3A7745	2/36	VW3A46121	2/42	VW3A47906	2/47
TSXCANCD300	2/29	VW3A5218	2/53		2/37	VW3A46122	2/42	VW3A47907	2/47
TSXCANKCDF180T	2/29	VW3A5219	2/53	VW3A7747	2/36	VW3A46123	2/42	VW3A47908	2/47
TSXCANTDM4	2/30	VW3A5301	2/49		2/38	VW3A46124	2/42	VW3A53901	2/53
			2/50	VW3A7748	2/34	VW3A46125	2/42	VW3A53902	2/51
		VW3A5302	2/49		2/36	VW3A46126	2/42		2/53
			2/50	VW3A7750	2/38	VW3A46127	2/42	VW3A53903	2/51
		VW3A5303	2/49		2/39	VW3A46128	2/42		2/53
			2/50	VW3A7751	2/38	VW3A46129	2/42	VW3A53904	2/53
		VW3A5304	2/49		2/39	VW3A46130	2/42	VW3A53905	2/51
			2/50	VW3A7752	2/38	VW3A46131	2/42	VW3A93111	2/48
		VW3A5305	2/49		2/39	VW3A46132	2/42	VW3A93112	2/48
			2/50	VW3A7753	2/38	VW3A46133	2/43	VW3A93113	2/48
		VW3A5306	2/49		2/39	VW3A46134	2/43	VW3A93114	2/48
			2/50	VW3A7754	2/38	VW3A46135	2/43	VW3A93115	2/48
		VW3A5307	2/49		2/39	VW3A46137	2/43	VW3A93116	2/48
			2/50	VW3A7755	2/38	VW3A46138	2/43	VW3A93117	2/48
		VW3A5401	2/52		2/39	VW3A46139	2/44	VW3A93118	2/48
			2/53	VW3A7756	2/38	VW3A46140	2/44	VW3A93119	2/48
		VW3A5402	2/52		2/39	VW3A46141	2/44	VW3A93120	2/48
			2/53	VW3A7757	2/36	VW3A46142	2/44	VW3A95116	2/13
		VW3A5403	2/52		2/38	VW3A46143	2/44	VW3AP0101	4/18
			2/53	VW3A8306R03	2/15	VW3A46144	2/44	VW3AP0102	4/18
		VW3A5404	2/52		2/28	VW3A46145	2/44	VW3AP0103	4/18
			2/53	VW3A8306R10	2/15	VW3A46146	2/44	VW3AP0104	4/18
		VW3A5405	2/52		2/28	VW3A46147	2/44	VW3AP0105	4/18
			2/53	VW3A8306R30	2/15	VW3A46148	2/44	VW3AP0106	4/18
		VW3A5406	2/52		2/28	VW3A46149	2/44	VW3AP0111	4/18
			2/53	VW3A8306RC	2/15	VW3A46150	2/44	VW3AP0112	4/18
		VW3A5407	2/52		2/28	VW3A46151	2/44	VW3AP0113	4/18
			2/53	VW3A8306TF03	2/15	VW3A46152	2/44	VW3AP0114	4/18
		VW3A7101	2/32		2/28	VW3A46153	2/44	VW3AP0115	4/18
			2/32	VW3A8306TF10	2/15	VW3A46154	2/44	VW3AP0116	4/18
		VW3A7105	2/32		2/28	VW3A46155	2/44	VW3AP0201	4/18
			2/32	VW3A9112	2/13	VW3A46157	2/44	VW3AP0202	4/18
		VW3A7106	2/32		2/13	VW3A46158	2/45	VW3AP0251	4/19
			2/32	VW3A9113	2/13	VW3A46159	2/45	VW3AP0252	4/19
		VW3A7730	2/34		2/13	VW3A46160	2/45	VW3AP0253	4/19
			2/35	VW3A9114	2/13	VW3A46161	2/45	VW3AP0254	4/19
			2/36	VW3A9212	2/13	VW3A46162	2/45	VW3AP0255	4/19
		VW3A7731	2/34		2/13	VW3A46163	2/45	VW3AP0271	4/19
			2/35	VW3A9213	2/13			VW3AP0272	4/19
			2/36	VW3A9513	2/13				
		VW3A7732	2/34		2/13				
			2/35	VW3A9514	2/13				
			2/36	VW3A9515	2/13				
		VW3A7733	2/34		2/13				
			2/35	VW3A9601	2/51				
			2/36		2/51				
		VW3A7734	2/34	VW3A9602	2/51				
			2/35		2/51				
			2/36	VW3A9612	2/51				
			2/36		2/51				
			2/36	VW3A9613	2/51				
			2/36		2/51				

VW3AP0273	4/19	VW3AP0816	4/19	VX5VPS3002	2/12
VW3AP0274	4/19	VW3AP0817	4/19	VX5VPS4001	2/12
VW3AP0275	4/19	VW3AP0819	4/19	VX5VPS5001	2/12
VW3AP0276	4/19	VW3AP0821	4/19	VX5VPS5002	2/12
VW3AP0301	4/17	VW3AP0851	4/17	VX5VPS6001	2/12
VW3AP0302	4/17	VW3AP0852	4/17	VZ3V1212	2/12
VW3AP0303	4/17	VW3AP0853	4/17	VZ3V1213	2/12
VW3AP0304	4/17	VW3AP0854	4/17		
VW3AP0305	4/17	VW3AP0855	4/17	Z	
VW3AP0351	4/17	VW3AP1101	4/19	ZB5AZ905	2/15
VW3AP0352	4/17	VW3AP1102	4/19		
VW3AP0353	4/17	VW3AP1103	4/19		
VW3AP0354	4/17	VW3AP1104	4/19		
VW3AP0355	4/17	VW3AP1105	4/19		
VW3AP0401	4/18	VW3AP1111	4/19		
VW3AP0402	4/18	VW3AP1112	4/19		
VW3AP0403	4/18	VW3AP1113	4/19		
VW3AP0404	4/18	VW3AP1114	4/19		
VW3AP0405	4/18	VW3AP1115	4/19		
VW3AP0415	4/16	VW3AP1121	4/19		
VW3AP0421	4/16	VW3AP1122	4/19		
VW3AP0501	4/17	VW3AP1123	4/19		
VW3AP0502	4/17	VW3AP1124	4/19		
VW3AP0503	4/17	VW3AP1125	4/19		
VW3AP0551	4/17	VW3AP1502	4/16		
VW3AP0552	4/17	VW3AP1503	4/16		
VW3AP0561	4/16	VW3AP1601	4/16		
VW3AP0562	4/16	VW3AP1801	4/16		
VW3AP0563	4/16	VW3AP1807	4/16		
VW3AP0564	4/16	VW3AP2001	4/16		
VW3AP0565	4/16	VW3AP2002	4/16		
VW3AP0566	4/16	VW3AP2003	4/16		
VW3AP0567	4/16	VW3AP2004	4/16		
VW3AP0568	4/16	VW3AP2101	4/16		
VW3AP0569	4/16	VW3AP2701	4/16		
VW3AP0601	4/18	VW3AP3203	4/16		
VW3AP0602	4/18	VW3AP3204	4/16		
VW3AP0611	4/18	VW3AP3420	4/16		
VW3AP0612	4/18	VW3AP3422	4/16		
VW3AP0613	4/18	VW3AP3423	4/16		
VW3AP0614	4/18	VW3AP3424	4/16		
VW3AP0615	4/18	VW3AP3601	4/16		
VW3AP0701	4/18	VW3AP3607	4/16		
VW3AP0702	4/18	VW3AP3608	4/16		
VW3AP0704	4/18	VW3AP3609	4/16		
VW3AP0705	4/18	VW3AP3618	4/16		
VW3AP0707	4/18	VW3AP3627	4/16		
VW3AP0708	4/18	VW3AP3628	4/16		
VW3AP0710	4/18	VW3CANCARR1	2/29		
VW3AP0711	4/18	VW3CANCARR03	2/29		
VW3AP0801	4/17	VW3CANTAP2	2/30		
VW3AP0802	4/17	VW3M4701	2/24		
VW3AP0803	4/17		2/31		
VW3AP0804	4/17	VX5VP50A001	2/12		
VW3AP0805	4/17	VX5VP50BC001	2/12		
VW3AP0811	4/19	VX5VPM001	2/12		
VW3AP0812	4/19	VX5VPM002	2/12		
VW3AP0813	4/19	VX5VPS1001	2/12		
VW3AP0814	4/19	VX5VPS2001	2/12		
VW3AP0815	4/19	VX5VPS3001	2/12		



www.schneider-electric.com/drives

Schneider Electric Industries SAS

Head Office
35, rue Joseph Monier
F-92500 Rueil-Malmaison
France

The information provided in this documentation contains general descriptions and/or technical characteristics of the performance of the products contained herein. This documentation is not intended as a substitute for and is not to be used for determining suitability or reliability of these products for specific user applications. It is the duty of any such user or integrator to perform the appropriate and complete risk analysis, evaluation and testing of the products with respect to the relevant specific application or use thereof. Neither Schneider Electric nor any of its affiliates or subsidiaries shall be responsible or liable for misuse of the information contained herein.

Design: Schneider Electric
Photos: Schneider Electric