

Variable speed drives Altivar Machine ATV340

Catalog

January 2017



Quick access to Product information

Select your Catalogue, your Training

Digi-Cat

The complete digital catalogue for industrial automation



Makes your choice easy every day, everywhere!



With just 3 clicks, you can reach the 7,000 pages of the Industrial Automation & Control catalogue, in both English and French.

- Digi-Cat is available on a USB key (for PC). To get your Digi-Cat, please contact your local center
- Download Digi-Cat from this address:

<http://digi-cat.schneider-electric.com/download.html>

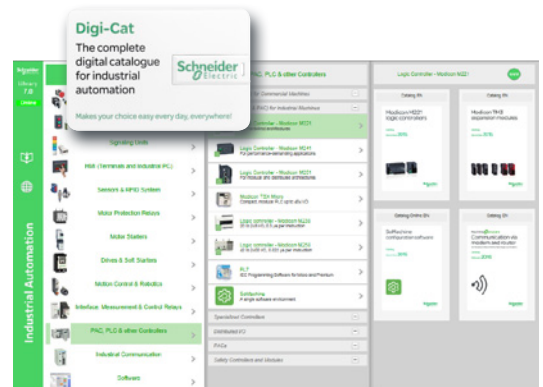

Find your training

- Find the right training for your needs
- Locate the training center with the selector tool, using this address:

<http://www.schneider-electric.com/b2b/en/services/training/technical-training.jsp>

then click on

Find your training center

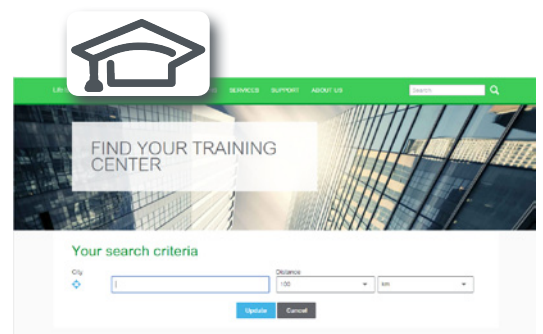

Life Is On



General contents

Altivar Machine ATV340 variable speed drives

■ General presentation.....	page 2
<i>Altivar Machine offer for Original Equipment Manufacturers</i>	<i>page 4</i>
■ Variable speed drives	page 6
□ Machine solution application.....	page 6
□ Presentation	page 8
□ References	page 12
■ Options	page 16
□ Configuration and runtime tools	page 16
□ Combinations	page 22
□ Encoder and I/O expansion modules	page 24
□ Communication modules	page 26
□ Braking resistors.....	page 33
□ Integrated EMC filters and additional EMC input filters	page 34
□ Line chokes	page 36
■ Motor starters	page 38
■ Dimensions	page 40
■ Product reference index.....	page 46

Variable speed drives

Altivar Machine ATV340

Advanced machine performance, reduced machine design time

Altivar Machine

Next level of automation performance

Altivar Machine drives offer extensive flexibility in machine applications. Depending on customer requirements, Ethernet embedded drives, and Modular drives are available up to 75 kW.

Modular drives from 0.75 kW to 22 kW

Ethernet drives from 0.75 kW to 75 kW



Latest innovations with up-to-date technology

Altivar Machine ATV340 drives

Advanced machine performance

Powerful dynamism and scalability

Altivar Machine ATV340 is a powerful drive that aims to match your machine's motor capabilities with maximum torque and speed performance.

With an optimized speed bandwidth up to 400 Hz, the Altivar Machine ATV340 is designed for dynamic applications that may require faster acceleration or settling time.

- > Robust enough to withstand high overloads, adaptable to the needs of demanding applications, it can provide up to 220% nominal torque during 2 s.
- > Compatible with a wide range of motors including asynchronous (IE2, IE3) motors, synchronous motor and reluctance motor for various applications in closed and open loop, to meet the adaptability and the scalability your machine requires.
- > Combination of ATV340 minimum application reaction time (1 ms task cycle) and Ethernet connectivity, maximizing your machine throughput.

220%

Nominal torque during 2 s

1 ms

Application cycle time

Reduced machine design time

Altivar Machine ATV340 drives will help reduce your engineering time at every stage of the process to speed up machine activation and operation.

Simplified machine engineering

Altivar Machine ATV340 accommodates numerous functions and features to simplify machine design and reduces the engineering time from selection to commissioning.

- > A wealth of interfaces, numerous I/O, Multi-Ethernet protocol, PTI/PTO, embedded encoders and multiple option interfaces offer maximum flexibility in architecture design.
- > Simple master/slave configuration, integrated application functions facilitate and fulfill application performance for hoisting, material handling, material working and packaging machine segments.



Reduced machine design time helps increase operation efficiency



Accelerate operation efficiency with machine drives

Variable speed drives

Altivar Machine ATV340

Reduced machine design time, sustained machine operation



TVDA's are combinations of Schneider Electric best-in-class products providing typical control architectures



FDT Technology: an international standard with broad acceptance in the automation industry



Reduced machine design time (continued)

Seamless automation integration

Ready-to-use MachineStruxure application libraries that are Tested Validated and Documented (TVDA), combined with Ethernet services available in ATV340, will facilitate your machine design and help you significantly reduce design time.

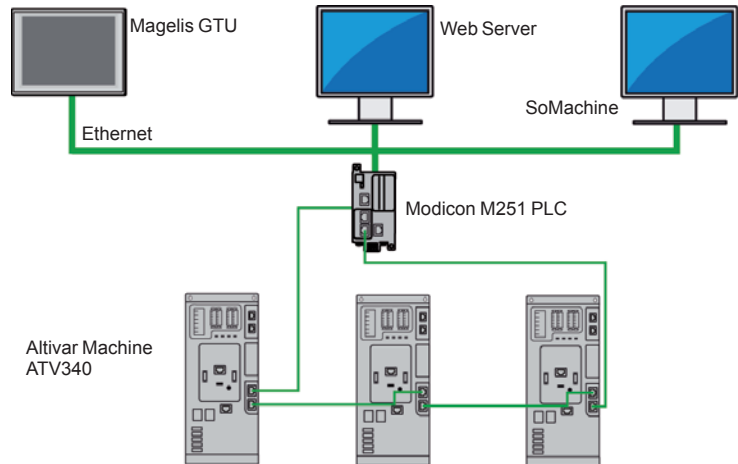

Integration in the SoMachine automation platform

- > FDT/DTM technology helps ensure the interoperability and user-friendliness of ATV340 in architectures with third-party PLCs.

- > The ONE button auto-tuning for motor identification simplifies the commissioning and the ability to replicate the complete project in a fast and seamless manner for maximum productivity in machine production.

Sustained machine operation

Robust design for long-lasting operation and reliable service

ATV340 has been designed to meet the needs of applications for harsh environments, such as vibration, shock and non-conductive dust and where high temperature resistance up to 60 °C is needed.

Help to protect people and assets while providing continuity of service

Compliant with machine safety and Cybersecurity standards, the Altivar Machine ATV340 drives offer an embedded solution, to include in your enduring protection system used for your people and assets.

- > Compliant with machine-related safety standards EN ISO 13849-1 and EN-62061

- > Achilles level 2 certification against cyber-attacks

Fast machine recovery

The Altivar Machine 340 keeps your machine up and running with minimal downtime due to features that include:

- > Fast Device Replacement (FDR) service: with the MachineStruxure architecture in place, device replacement takes just two simple steps by the service technician. Firstly, the pluggable connectors mean a new drive can be fitted in less than 3 minutes, then the drive configuration can be downloaded from the PLC in a single action.

- > Data logging and monitoring by the local system or remote monitoring via the embedded web server give users access to any motor or application-relevant data anytime, anywhere. This information can be used for predictive maintenance and to avoid breakdowns.



Achilles™ Level 2 certified



Cybersecurity for your assets

+ Suit to design service concept

Application segments	General
	Specific

Material handling, packaging, textiles, hoisting, mechanical actuators, material working
Conveyors, carton packers, gantry cranes, woodworking, metal processing, fans, etc.



Degree of protection	IP20	IP20
Power range for 50..60 Hz supply	Single-phase 200..240V Three-phase 200..240V Three-phase 380..480V Three-phase 380..500V Three-phase 525..600V	0.18...2.2 kW/0.25... 3 HP 0.18...15 kW/0.25...20 HP - 0.37...4 kW/0.5...5 HP 0.75...15 kW/1...20 HP
Drive	Output frequency Control type Asynchronous motor Synchronous motor Motor sensor Integrated as an option Overload torque performance	0.1...599 Hz U/F ratio (2 points, 5 points, energy saving, quadratic), Flux vector control without sensor (Standard and Energy saving) Vector control without sensor - RS422 (speed monitoring) Up to 200% Tn in an open loop
Functions	Advanced functions	<ul style="list-style-type: none"> Control of asynchronous and synchronous motors; including IE2, IE3 and PM motors in open loop MachineStructure integration in SoMachine Operation in Velocity mode and Torque control (with current limitation) Customizable and flexible application functions with ATV Logic (up to 50 function blocks) Numerous application functions for targeted application segments Embedded safety functions dedicated to targeted application segments
	Integrated safety functions Number of preset speeds	STO (up to SIL3 / PLe), SS1, SLS, SMS, GDL 16
Number of integrated I/O	Analog inputs Digital inputs Analog outputs Digital outputs Relay outputs Safety function inputs	3: 1 Bipolar differential ±10 V, 1 with Voltage ±10 V and 1 with current (0-20 mA) 6: 4 configurable (positive or negative logic), 1 with PTC probe input, 1x20kHz pulse input 1: Configurable as voltage (0...10 V) or current (0-20 mA) 1: Configurable as voltage or current 2: 1 with NO/NC contacts and 1 with NC contacts 1 + 4: 1 with STO and 4 configurable for safety functions from digital inputs
Optional I/O extension module	-	-
Communication	Integrated Optional	Single port compatible with CANopen and Modbus Serial line Ethernet IP and Modbus TCP, CANopen RJ45 Daisy Chain, Sub-D, and screw terminals, PROFINET, Profibus DP V1, EtherCAT, and DeviceNet
Configuration and runtime tools		integrated Display, DTM (Device Type Manager), SoMove software, simple loader (optional) and multiloader (optional)
Standards and certifications		IEC 61800-5-1, IEC 61800-3 (environments 1 and 2, category C2), UL 508C, EN 954-1 category 3, ISO/EN 13849-1/- 2 category 3 (PL e), IEC 61508 (parts 1 & 2) SIL 2 level, draft standard EN 50495E IEC 60721-3-3, classes 3C3 and 3S2 CE, UL, CSA, RCM, EAC, ATEX
References	ATV320●●●●●C	ATV320●●●●●B

Packaging, material handling, material working, hoisting
Palletizers, shrink wrapping machines, cardboard box folding machines, standard cranes, automatic storage systems, grouping conveyors, slitters, etc.



Degree of protection	IP20	IP20	IP20
Power range for 50..60 Hz supply	-	-	0.75...22 kW/1...30 HP 0.75...22 kW/1...30 HP 30...75 kW/40...100 HP
Drive	0.1...599 Hz Voltage vector control without sensor, Current Vector control with Sensor, U/F 5 points, Energy saving mode		
	Open-loop synchronous motor control (with and without stall monitoring), closed-loop synchronous motor control, synchronous reluctance motor control RS422 Incremental, Sincos		
	Digital (RS422 incremental, EnDat2.2, SSI), analog (sin/cos 1Vpp), resolver Up to 220% Tn in open loop or closed loop control		Up to 180% Tn in open or closed loop control
Functions	<ul style="list-style-type: none"> Control of asynchronous, synchronous, special motors including all efficiency classes, PM motors, torque motors, conical sliding rotor, reluctance Advanced MachineStructure integration in SoMachine Operation in Velocity mode, Torque mode Possibility of adding I/O expansion cards, or optional encoder feedback modules Numerous application functions for targeted application segments Very dynamic motor control performance (up to 400 Hz speed bandwidth) and cyclic application task (1 ms) Possibility of Master/Slave daisy chain through PTO/ PTI 		<ul style="list-style-type: none"> Integrated Ethernet IP and Modbus TCP dual port, cyber security (Achilles Level 2) Via integrated web server continuous and realtime application data with customizable dashboards Master/Slave drive-to-drive link via Ethernet
	STO SIL3/PLe with dual input 16		
Number of integrated I/O	2: 1 configurable (voltage/current/thermal probe) and 1 with bipolar differential ±10 V ---		3: Configurable as voltage (0...±10 V ---) or current (0-20 mA/4-20 mA), including 2 for probes (PTC, PT100, PT1000, or KTY84)
	5 + 2: 5 configurable (positive or negative logic) and 2 which can be configured as digital input or output 1: Configurable as voltage (0...10 V ---) or current (x...20 mA)		8: Configurable (positive or negative logic) 2: Configurable as voltage (0..10 V ---) or current (x...20 mA)
	2: Assignable 2: 1 with NO/NC contacts and 1 with NC contacts 2: STO_A, STO_B for STO safety function		1: Assignable 3: 1 with NO/NC and 2 with NO contacts 2: STO_A, STO_B for STO safety function
Optional I/O extension module	I/O expansion module and/or relay expansion module		
Communication	2 ports for Modbus serial line CANopen RJ45 Daisy Chain, Sub-D, and screw terminals, PROFINET, Profibus DP V1, EtherCAT, and DeviceNet	Dual port for Ethernet IP/Modbus TCP, 2 ports for Modbus serial line	
Configuration and runtime tools	Status display LEDs, Display (optional), DTM (Device Type Manager), SoMove software	Status display LEDs, Embedded Web server, Display (optional), DTM (Device Type Manager), SoMove software	
Standards and certifications	UL508C/UL61800-5-1, EN/IEC 61800-3, Environment 1 category C2, EN/IEC 61800-3, Environment 2 category C3, EN/IEC 61800-5-1, IEC 60721-3-3, classes 3C3 and 3S3, IEC 61508, IEC 13849-1, Green Premium, Reach/RoHS		
References	ATV340●●●N4	ATV340●●●N4E	

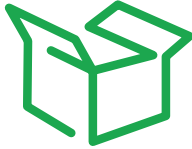

Packaging

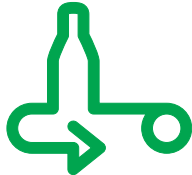

Material Handling



Material Working



Hoisting

Machine solution

The Altivar Machine ATV340 is an IP 20 high-performance variable speed drive for three-phase synchronous and asynchronous motors in open and closed loop control. ATV340 incorporates functions and features suitable for the most common applications, including:

- Packaging
- Material handling
- Material working
- Hoisting

The Altivar Machine ATV340 is designed to meet the needs of most demanding automation requirements and machine throughput performance combined with simplicity in selection, engineering & design (automation integration), commissioning, machine mass production and sustaining machine operation including services for machine builders.

The Altivar Machine ATV340 offers realtime automation capabilities, simplified machine engineering and superior performance for industrial machine applications:

- Dynamic and powerful motor control for asynchronous, synchronous and reluctance motors
- Drive cycle in real time for most demanding automation requirements
- Complete integration into any system architecture by offering a native Ethernet product in real time and commonly used industrial communication field buses (CANopen, Profinet, EtherCAT, etc.)
- The drive features and dedicated application functions are the benchmark for high performance requirements
- Safe torque off (STO) with dual inputs compliant with SIL3/PLe to meet machine safety standards
- Data logging, web server, I/O scanning, easy addressing and many other services are possible with the Ethernet version, reducing the machine design time and improving machine operation.

The Altivar Machine ATV340 helps to enhance machine performance, reduce machine design time and sustain machine operation, meeting the needs of original equipment manufacturers by pinpointing all the vital stages of the machine lifecycle.

Schneider Electric's MachineStruxure solutions provide abundant ready-to-use, PLCopen-compliant libraries. SoMachine can be used to develop, configure, and set up an entire machine in a single software environment. Using FDT/DTM technology, it is possible to configure, control, and diagnose Altivar Machine ATV340 drives directly in SoMachine and SoMove software by means of the same software brick (DTM).

SoMachine provides verified and documented application libraries for Altivar Machine ATV340 with seamless integration under this platform. Altivar Machine ATV340 benefits from the advantage of reducing engineering and design time for machine builders.



Palletizer



Grouping conveyor



Automatic storage system



Material working

Applications

Altivar Machine ATV340 drives embed functions for high-performance machine requirements in the following applications:

Packaging

- Palletizers
- Shrink wrapping machines
- Cardboard box folding machines

Material handling

- Standard cranes
- Automatic storage systems
- Grouping ungrouping conveyors

Material working

- Slitters
- Panel dividing saw
- Cable twisting

Hoisting

- Standard cranes



ATV340U22N4 (2) ATV340U75N4 (2)



ATV340U22N4E (2) ATV340U75N4E (2) ATV340D22N4E(2)



ATV340D37N4E (2) ATV340D75N4E (2)

The offer

The Altivar Machine ATV340 range of variable speed drives covers motor power ratings from 0.75 kW/1 HP to 75 kW/100 HP in heavy duty, with 2 product types: Modular and Ethernet products:

- 380 V...480 V three-phase, 0.75 kW/1 HP to 22 kW/30 HP covers Modular type (ATV340U07N4 to ATV340D22N4)
- 380 V...480 V three-phase, 0.75 kW/1 HP to 75 kW/100 HP covers Ethernet type (ATV340U07N4E to ATV340D75N4E)

Modular type is designed to accommodate the majority of commonly used industrial fieldbus protocols for simple integration in various automation architectures. References ending with "E" indicate the Ethernet version product with multi-protocol Ethernet embedded. Multi-Ethernet protocol consists of Ethernet IP and Modbus TCP communication interfaces.

Both the Modular version and Ethernet version have a book format up to 7.5 kW/10 HP and all sizes can be mounted side by side in order to optimize the machine footprint. The Altivar Machine ATV340 range is designed to withstand harsh ambient conditions, as references comply with IEC 60721-3-3 Class 3C3 and 3S3 and can operate up to 60 °C with derating and 50 °C without derating as standard.

The Altivar Machine ATV340 drives integrate Modbus serial line communication protocols as standard. Each device is equipped with 2 RJ45 ports dedicated to:

- Drive connection for configuration software
- Connecting an HMI (keypad) to the drive

In addition to that, the ATV340 Ethernet drives contain dual RJ45 port Multi-Ethernet protocol. The Multi-Ethernet protocol integrates Ethernet IP and Modbus TCP as standard.

The Ethernet drives are able to accommodate 2 slots for option modules serving different purposes.

- GP – SF slot dedicated to optional safety functions module and I/O expansion modules
- GP – ENC slot designed to take an encoder option module or I/O expansion module

Modular drives ATV340U●●N4 are equipped with 3 slots for optional modules, the GP – FB slot being the only difference from the ATV340 Ethernet drive.

- The GP – FB slot can be used for a communication option module to control the drive. ATV340 Modular drives are compatible with the communication interfaces below:

- CANopen
- PROFIBUS DP V1
- DeviceNet
- EtherCAT
- ProfiNet

See page 26.

Heavy duty as standard sizing

Altivar Machine ATV340 drives are sized heavy duty as standard. In the case of lower cycle applications (requiring lower starting current) ATV340 drives can also be sized as normal duty:

- Heavy duty: dedicated mode for applications requiring significant overload (up to 1.5 In for 60 s and up to 1.8 In (1) for 2 s), the recommended drive selection is standard sizing.
- Normal duty: dedicated mode for applications requiring slight overload (up to 1.2 In for 60 s and up to 1.35 In for 2 s), the recommended drive selection is one rating lower. For more details please refer to the installation manual.

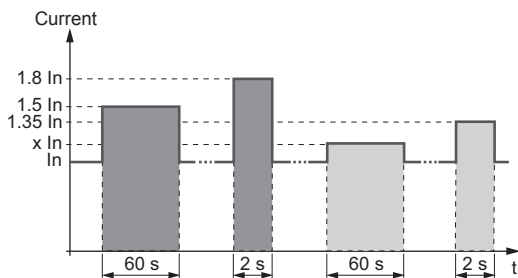

- Heavy duty operating mode
- Normal duty operating mode

Note:
for ATV340U07...D22N4● drives, x In = 1.1 In;
for ATV340D30...D75N4E drives, x In = 1.2 In

(1) See the selection table in page 12.

(2) Drives are shown with optional plain text display, which can be ordered as an add-on.

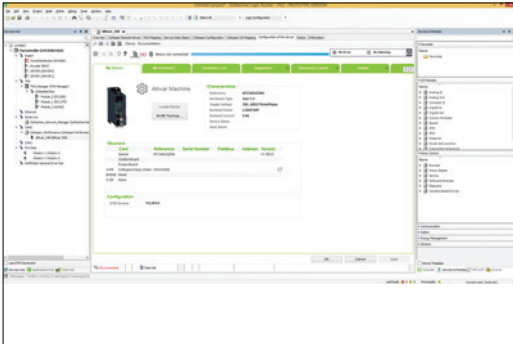

Altivar Machine DTM in SoMachine

Integration

Fieldbus protocols

- EtherNet/IP and Modbus/TCP Dual port (1) and Modbus serial link:
 - Standard Modbus and Ethernet protocols
 - Connection of configuration and runtime tools
- Control of the Altivar Machine ATV340 in automation architectures (PLCs, IPCs, HMI, etc.) in industrial network protocols for reading/writing data (2):
 - Diagnostic, supervision, and fieldbus management functions
- Ethernet services:
 - SNMP, SNTP, BootP & DHCP, IP v6, cybersecurity services, FDR
 - Open Ethernet topologies

Integration of configuration and runtime tools

- FDT/DTM technology (see page 20):
 - Drive configuration, diagnostics, and control using SoMachine software with Modicon Machine Solution controllers

Dialog and configuration tools

- LED display terminals on front:
 - Monitoring drive status
- Graphic display terminal (see page 16) (3):
 - Drive control, adjustment, and configuration
 - Display of current values (motor, I/O, etc.)
 - Configuration storage and download
 - Duplication of one drive configuration on another drive from a PC or another drive
 - Connection to several drives using multidrop link components (see page 27)
- Embedded web server (see page 20):
 - Easily accessible from any PC, iPhone, iPad, Android system, and major web browsers
 - Network diagnostics in real time
 - Read/write values
- SoMove software (see page 21):
 - Advanced functions for configuration, setup, and maintenance of Altivar Machine drives

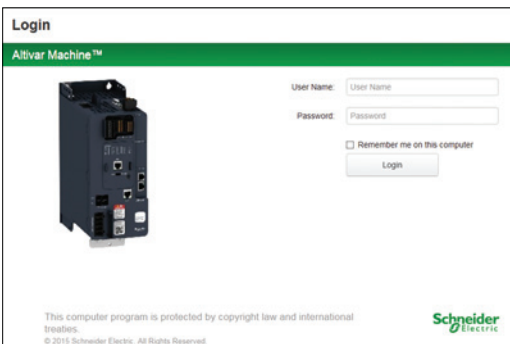

Embedded web server login screen

Accessories and replacement parts

Accessories

- Display terminal:
 - Plain text display for direct or remote mounting (see page 16)
 - Graphic display terminal for extended mounting (see page 18)
 - Remote mounting kit for mounting on enclosure door (see page 17)
 - Multidrop connection accessories for connecting several drives to the RJ45 terminal port (see page 27)
- Drive to drive plus connection accessories (see page 13)
- Flange mounting kit: design for evacuating dissipated heat through the power section by mounting the power part outside an electrical cabinet (see page 13)
- Daisy chain DC bus sharing cable for cost-optimized installations, to create a simple zDC bus link (see page 13)

Replacement parts

- Fan kit (see page 13)
- Connector kits for I/O, motor and power connection (see page 13)

(1) Ethernet devices only.

(2) See previous page for compatible automation field buses in addition to Ethernet IP and Modbus TCP.

(3) There are 2 possible options for display: mounting on the drive or mounting on the enclosure door using the mounting kit and extension accessories.



Inserting relay module VW3A3204 into slot GP-SF of the Ethernet ATV340 drive, ATV340U07N4E.

Options

- Modules (see page 24):
- Encoder modules (see page 24):
 - Digital interface encoder module 5/12 V
 - Resolver interface module
 - Analog interface encoder module
- I/O extension (see page 25):
 - 2 analog inputs
 - 6 digital inputs
 - 2 digital outputs
 - 3 NO contacts with relay output
- Communication (see page 26):
 - CANopen: RJ45 daisy chain, SUB-D, 5-way screw terminals
 - PROFINET
 - Profibus DP V1
 - EtherCAT
 - DeviceNet
- Braking resistors (see page 32)
- Additional EMC input filters for reducing conducted emissions on the mains (see page 34)
- Line chokes to reduce the THDi of a system (see page 36)

Motor starters

Schneider Electric offers combinations of circuit breakers and contactors so that Altivar Machine drives can be used in optimum conditions (see page 38). For prospective line short circuit current up to 100 kA, please contact our Customer Care Center.

Standards and certifications

Altivar Machine ATV340 drives have been developed to conform to the international standards and recommendations relating to industrial electrical control devices (IEC), in particular:

- UL508C/UL61800-5-1
- IEC 61800-3:
 - EN/IEC 61800-3, Environments 1 category C2
 - EN/IEC 61800-3, Environments 2 category C3
- EN/IEC 61800-5-1
- IEC 60721-3
- IEC 61508
- IEC 13849-1
- Green Premium, Reach/RoHS

Altivar Machine ATV340 drives are certified:

- UL
- CSA
- TÜV
- Green Premium, RoHS EU, China

They are CE marked according to the European low voltage (2014/35/EU) and EMC (2014/30/EU) directives.

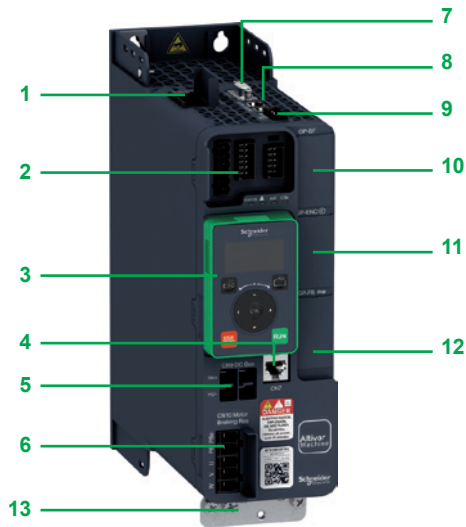

Description

- 1 Power supply terminals
- 2 I/O connection (1):
 - 5 digital inputs:
 - Configurable as positive digital input (source) or negative digital input (sink) compliant with IEC61131-2 PLC standards:
 - 24 V $\overline{\text{---}}$, impedance 4.4 k Ω , sampling time 1 ms +/- 250 μs , response time 1 ms.
 - 2 digital inputs or outputs:
 - Configurable and compliant with IEC61131-2 PLC standards
 - 24 V $\overline{\text{---}}$, sampling time 2 ms, maximum voltage 30 V, maximum current 100 mA
 - 2 relay outputs: R1 (3 NO and NC contacts) and R2 (2 NC contacts)
 - R1 - 1 NC contact and 1 NO contact with common point, minimum switching capacity 5 mA for 24 V $\overline{\text{---}}$, maximum switching capacity 3 A on resistive load, 2 A on inductive load for 250 V \sim or 30 V $\overline{\text{---}}$
 - R2 - 1 NC contact, maximum switching capacity 5 A on resistive load
 - 2 analog inputs:
 - 1 configurable (voltage/current/PTC-PT100) analog input, by programming X and Y from 0 to 20 mA
 - 1 bipolar ± 10 V $\overline{\text{---}}$ analog input, sampling time 250 μs
 - 1 analog output, 2 ms +/- 0.5 ms sampling time and 10-bit resolution, configurable as:
 - voltage analog output 0...10 V $\overline{\text{---}}$, minimum load impedance 470 Ω
 - current analog output "x to y" mA, maximum load impedance 500 Ω
- 3 Plain text display terminal (can be mounted as an option)
- 4 Modbus Serial line RJ45 port
- 5 DC Bus connection link (2)
- 6 Motor and braking resistor connector
- 7 Encoder feedback interface is compatible with RS422 incremental (A/B/I) and sin/cos 1Vpp (SC) interfaces, supply voltage 5 V, 12 V and 24 V (3)
- 8 Pulse train output (PTO) and Pulse train input (PTI) interface can be used to control the drive via PLC or using hard wired master slave applications. The interface is equipped with 2 RJ45 ports and the pulse counter can be set 0...200 kpps (4)
- 9 Safe torque off (STO) dual input SIL3/PLe and 24 V $\overline{\text{---}}$ supply in/out
- 10 GP – SF slot for Safety option module or I/O expansion module (see page 25) (5)
- 11 GP – ENC slot for Encoder interface module (see page 24) or I/O expansion module (see page 24)
- 12 GP – FB slot for communication option module (see page 26) or I/O expansion module (see page 24) (6)

(1) ATV340D30N4E to ATV340D75N4E references have: 8 digital inputs (positive or negative logic), 1 assignable digital output, 3 analog inputs configurable as voltage or current, including 2 for probes (PTC, PT100, PT1000, or KTY84), 2 analog outputs configurable as voltage (0..10 V) or current (0-20 mA), 3 relay outputs - 1 with NO/NC and 2 with NO contacts.

(2) ATV340D30N4E to ATV340D75N4E references: DC bus connection is possible but not located on the front of the product, for more details please refer to the installation manual.

(3) ATV340D30N4E to ATV340D75N4E references requires an encoder option module for closed loop operation.

(4) ATV340D30N4E to ATV340D75N4E references do not have PTI/PTO for master/slave operation. Drive-to-drive link via Ethernet or analog inputs and outputs can be used.

(5) ATV340D30N4E to ATV340D75N4E references have different option slot positions, for more details please refer to the installation manual.

(6) ATV340●●●N4E references are equipped with dual port Ethernet IP/Modbus TCP communication, communication option modules can be inserted in ATV340D30N4E...D75N4E references. For more details please refer to the installation manual.

Variable speed drives

Altivar Machine ATV340

Three-phase supply voltage: 380...480 V 50/60 Hz



ATV340U22N4



ATV340U75N4



ATV340D22N4

Variable Speed Drives Modular drive (1)											
Motor	Supply mains						Altivar Machine			Reference (1)	Weight
	Power indicated on rating plate (2)		Input current (3)		Apparent power	Prospective line Isc	Maximum continuous current (2)	Maximum transient current for 2 s	Maximum transient current for 60 s		
HD: Heavy duty (5)			380 V	480 V	380 V						
ND: Normal duty (4)											
	kW	HP	A	A	kVA	kA	A	A	A	kg/lb	
Three-phase supply voltage: 380...480 V 50/60 Hz											
HD	0.75	1	3.4	2.6	2.2	5	2.2	4	3.3	ATV340U07N4 1.700/3.748	
ND	1.1	1.5	3.3	2.6	2.2	5	2.8	3.8	3.1		
HD	1.5	2	6	4.9	4.1	5	4	7.2	6	ATV340U15N4 1.700/3.748	
ND	2.2	3	5.7	4.6	3.8	5	5.6	7.6	6.2		
HD	2.2	3	8.4	6.6	5.5	5	5.6	10.1	8.4	ATV340U22N4 1.800/3.968	
ND	3	3	7.7	6.2	5.2	5	7.2	9.7	7.9		
HD	3	3	10.7	8.5	7.1	5	7.2	13	10.8	ATV340U30N4 2.100/4.630	
ND	4	5	10.1	8.1	6.7	5	9.3	12.6	10.2		
HD	4	5	13.4	10.6	8.8	5	9.3	16.7	14	ATV340U40N4 2.200/4.850	
ND	5.5	7	13.4	10.8	9	5	12.7	17.1	14		
HD	5.5	7	20	16	13.3	22	12.7	22.9	19.1	ATV340U55N4 2.900/6.393	
ND	7.5	10	18	14.5	12.1	22	16.5	22.3	18.2		
HD	7.5	10	25.6	20.4	17	22	16.5	29.7	24.8	ATV340U75N4 3.000/6.614	
ND	11	15	25.5	20.5	17	22	24	32.4	26.4		
HD	11	15	34.7	27.7	23	22	24	43	36	ATV340D11N4 9.500/20.944	
ND	15	20	34	27.3	22.7	22	32	43	35.2		
HD	15	20	44.9	35.7	29.7	22	32	58	48	ATV340D15N4 9.500/20.944	
ND	18.5	25	42.3	34	28.3	22	39	53	42.9		
HD	18.5	25	54.7	43.4	36.1	22	39	70	59	ATV340D18N4 10.200/22.487	
ND	22	30	50	40.2	33.4	22	46	62	50.6		
HD	22	30	63.5	50.6	42.1	22	46	83	69	ATV340D22N4 10.200/22.487	
ND	30	40	67.7	54.3	45.1	22	62	84	68.2		

- (1) Altivar Machine **ATV340●●●N4** drives integrate EMC filter category C3 with 20 m/65.62 ft shielded motor cable.
- (2) These values are given for a nominal switching frequency of 4 kHz up to **ATV340D22N4E**, for use in continuous operation. The switching frequency is adjustable. Above 4 kHz, the drive will automatically reduce the switching frequency in the event of an excessive temperature rise. For continuous operation above the nominal switching frequency, derate the nominal drive current (see derating curves on our website www.schneider-electric.com).
- (3) Typical value for the indicated motor power and for the prospective line Isc.
- (4) Values given for applications requiring slight overload (up to 135% for 2 s and 110% for 60 s).
- (5) Values given for applications requiring significant overload (up to 180% for 2 s and 150% for 60 s).

Note: Drives are shown with optional plain text display, which can be ordered as an add-on. Consult the summary tables of possible drive, option, and accessories combinations (see page 22). Ambient temperature range:

- For normal duty operation mode: ATV340U07...D22N4● 0 ~ 40 °C without de-rating (up to 60 °C with de-rating)
 - For heavy duty operation mode: ATV340U07...D22N4● 0 ~ 50 °C without de-rating (up to 60 °C with de-rating)
- For more details regarding the thermal capacity of references, please visit www.schneider-electric.com

Variable speed drives

Altivar Machine ATV340

Three-phase supply voltage: 380...480 V 50/60 Hz



ATV340U22N4E



ATV340U75N4E



ATV340D22N4E



ATV340D37N4E

Variable Speed Drives Ethernet drive ⁽¹⁾											
Motor	Supply mains						Altivar Machine			Reference ⁽¹⁾	Weight
Power indicated on rating plate ⁽²⁾	Input current ⁽³⁾		Apparent power		Prospective line Isc	Maximum continuous current ⁽²⁾	Maximum transient current for 2 s	Maximum transient current for 60 s			
HD: Heavy duty ⁽⁵⁾	380 V	480 V	380 V						A	A	A
ND: Normal duty ⁽⁴⁾	kW	HP	A	A	kVA	kA	A	A	A	kg/lb	
Three-phase supply voltage: 380...480 V 50/60 Hz											
HD	0.75	1	3.4	2.6	2.2	5	2.2	4	3.3	ATV340U07N4E	1.700/ 3.748
ND	1.1	1.5	3.3	2.6	2.2	5	2.8	3.8	3.1		
HD	1.5	2	6	4.9	4.1	5	4	7.2	6	ATV340U15N4E	1.700/ 3.748
ND	2.2	3	5.7	4.6	3.8	5	5.6	7.6	6.2		
HD	2.2	3	8.4	6.6	5.5	5	5.6	10.1	8.4	ATV340U22N4E	1.800/ 3.968
ND	3	3	7.7	6.2	5.2	5	7.2	9.7	7.9		
HD	3	3	10.7	8.5	7.1	5	7.2	13	10.8	ATV340U30N4E	2.100/ 4.630
ND	4	5	10.1	8.1	6.7	5	9.3	12.6	10.2		
HD	4	5	13.4	10.6	8.8	5	9.3	16.7	14	ATV340U40N4E	2.200/ 4.850
ND	5.5	7	13.4	10.8	9	5	12.7	17.1	14		
HD	5.5	7	20	16	13.3	22	12.7	22.9	19.1	ATV340U55N4E	2.900/ 6.393
ND	7.5	10	18	14.5	12.1	22	16.5	22.3	18.2		
HD	7.5	10	25.6	20.4	17	22	16.5	29.7	24.8	ATV340U75N4E	3.000/ 6.614
ND	11	15	25.5	20.5	17	22	24	32.4	26.4		
HD	11	15	34.7	27.7	23	22	24	43	36	ATV340D11N4E	9.500/ 20.944
ND	15	20	34	27.3	22.7	22	32	43	35.2		
HD	15	20	44.9	35.7	29.7	22	32	58	48	ATV340D15N4E	9.500/ 20.944
ND	18.5	25	42.3	34	28.3	22	39	53	42.9		
HD	18.5	25	54.7	43.4	36.1	22	39	70	59	ATV340D18N4E	10.200/ 22.487
ND	22	30	50	40.2	33.4	22	46	62	50.6		
HD	22	30	63.5	50.6	42.1	22	46	83	69	ATV340D22N4E	10.200/ 22.487
ND	30	40	67.7	54.3	45.1	22	62	84	68.2		
HD	30	40	54.8	48.3	40.2	50	61.5	92.25	92.25	ATV340D30N4E	27.900/ 61.509
ND	37	50	66.2	57.3	47.6	50	74.5	89.4	89.4		
HD	37	50	67.1	59	49.1	50	74.5	111.75	111.75	ATV340D37N4E	28.400/ 62.611
ND	45	60	78.9	69.1	57.4	50	88	105.6	105.6		
HD	45	60	81.4	71.8	59.7	50	88	132	132	ATV340D45N4E	56.400/ 124.341
ND	55	75	97.2	84.2	70	50	106	127.2	127.2		
HD	55	75	98.9	86.9	72.2	50	106	159	159	ATV340D55N4E	57.900/ 127.648
ND	75	100	131.3	112.7	93.7	50	145	174	174		
HD	75	100	134.3	118.1	98.2	50	145	217.5	217.5	ATV340D75N4E	58.400/ 128.750
ND	90	125	156.2	135.8	112.9	50	173	207.6	207.6		

- (1) Altivar Machine ATV340U07...D22N4E drives integrate EMC filter category C3 with 20 m/65.62 ft shielded motor cable. ATV340D30...D37N4E integrate EMC filter category C2 with 50 m/164.04 ft motor cable and category C3 with 150 m/492.12 ft motor cable. ATV340D45...D75N4E integrate EMC filter category C3 with 150 m/492.12 ft shielded motor cable.
- (2) These values are given for a nominal switching frequency of 4 kHz up to **ATV340D37N4E** (2.5 kHz for **ATV340D45N4E...ATV340U75N4E**), for use in continuous operation. The switching frequency is adjustable. Above 2.5 or 4 kHz (depending on the rating), the drive will automatically reduce the switching frequency in the event of an excessive temperature rise. For continuous operation above the nominal switching frequency, derate the nominal drive current (see derating curves on our website www.schneider-electric.com).
- (3) Typical value for the indicated motor power and for the prospective line Isc.
- (4) Values given for applications requiring slight overload (up to 135% for 2 s and 110% for 60 s).
- (5) Values given for applications requiring significant overload (up to 180% for 2 s and 150% for 60 s).

Note: Drives are shown with optional plain text display, which can be ordered as an add-on. Consult the summary tables of possible drive, option, and accessory combinations (see page 22). Ambient temperature range:

- For normal duty operation mode:
 - ATV340U07...D22N4E 0 ~ 40 °C without de-rating (up to 60°C with de-rating)
 - ATV340D30...D75N4E 0 ~ 40 °C without de-rating (up to 60°C with de-rating)
- For heavy duty operation mode:
 - ATV340U07...D22N4E 0 ~ 50 °C without de-rating (up to 60°C with de-rating)
 - ATV340D30...D75N4E -15 ~ 50 °C without de-rating (up to 60°C with de-rating)

For more details regarding the thermal capacity of references, please visit www.schneider-electric.com



EMC kit VW3A4430

Mounting accessories			
Description	For use with	Reference	Weight kg/lb
EMC kit	ATV340U07N4...U40N4 ATV340U07N4E...U40N4E	VW3A4430	0.292/ 0.644
	ATV340U55N4...U75N4 ATV340U55N4E...U75N4E	VW3A4431	0.320/ 0.705
	ATV340D11N4...D22N4 ATV340D11N4E...D22N4E	VW3A4432	0.423/ 0.933
Flush-mounting kit for separate air flow For mounting the drive power section outside the enclosure This contains: ■ Fixing accessories ■ 1 metal frame ■ Screws and seals ■ 1 user manual	ATV340D11N4...D22N4 ATV340D11N4E...D22N4E	VW3M2606	2.100/ 4.630
	ATV340D30N4E...D37N4E	NSYPTDS4	–
	ATV340D45N4E...D75N4E	NSYPTDS5	–

Connection accessories					
Daisy chain connection of the DC bus (1)					
The DC bus is possible to be connected in a daisy chain in the following cases: ■ Drives powered by the AC supply with parallel connection of the DC bus in order to balance the loads during braking phases between the drives; used in addition to braking resistors (see page 32) ■ Drives powered by the DC bus only This requires the connection accessories listed below:					
Description	Use	Length m/ft	Sold in lots of	Reference	Weight kg/lb
Cordset (1) equipped with 2 connectors	ATV340U07...U75N4	0.18/ 0.59	5	VW3M7101R01	–
	ATV340U07...U75N4E				
Shielded cable	ATV340U07...U75N4	15/ 49.21	1	VW3M7102R150	–
	ATV340U07...U75N4E				
Connection kit for VW3M7102R150 cable	–	–	10	VW3M2207	–
Daisy chain connection or pulse control	Equipped with 2 RJ45 connectors	0.3/ 0.98	1	VW3M8502R03	0.025/ 0.055
		1.5/ 4.92	1	VW3M8502R15	0.062/ 0.137
	Equipped with 1 RJ45 connector and a free end	3/ 9.84	1	VW3M8223R30	–

(1) For more details on DC bus sharing applications, please consult our Custom Care Center.

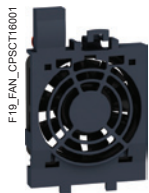

FIG_FAN_CPSCT10001

Fan kit VX5VMS1001

Replacement parts			
Description	For use with	Reference	Weight kg/lb
Fan kit			
Power fan for IP 21 drives, bracket, instruction sheets	ATV340U07N4...U40N4 ATV340U07N4E...U40N4E	VX5VMS1001	–
	ATV340U55N4...U75N4 ATV340U55N4E...U75N4E	VX5VMS2001	–
	ATV340D11N4...D22N4 ATV340D11N4E...D22N4E	VX5VMS3001	–
	ATV340D30N4E...D37N4E	VX5VPS4001	–
	ATV340D45N4E...D75N4E	VX5VPS5001	–
Connector kit for I/O, motor and power connection	ATV340U07N4...U40N4 ATV340U07N4E...U40N4E	VW3A34001	–
	ATV340U55N4...U75N4 ATV340U55N4E...U75N4E	VW3A34002	–
	ATV340D11N4...D22N4 ATV340D11N4E...D22N4E	VW3A34003	–

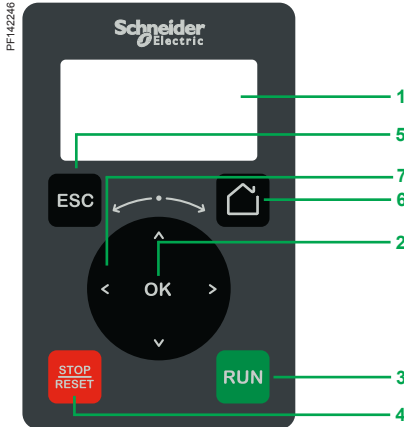

Plain text display terminal

Plain text display terminal

The plain text display terminal can be ordered separately, and can be:

- Connected and mounted on the front of the drive
- Connected and mounted on an enclosure door using a remote-mounting accessory

This terminal is used to:

- Control, adjust, and configure the drive
- Display current values (motor, I/O, and machine data)
- Store and download configurations (several configuration files can be stored in the memory)
- Duplicate the configuration of one powered-up drive on another powered-up drive

Other features:

- Displaying the Device - Web server matching password; a display terminal is required to log in to the Web server for the first time.
- Realtime clock providing data acquisition and event time stamping functions
- 2 lines
- Languages (Chinese, English, French, German, Italian, Spanish)
- White backlit LCD screen
- Operating range: -15...50 °C/+5...122 °F
- IP 21 protection
- Removable, easily plug-in with RJ45 port

Description

The front of the display terminal comprises:

- 1 LCD backlight screen
- 2 OK button: saves the current value (ENT)
- 3 RUN button: local control of motor run command
- 4 STOP/RESET button: local control of motor stop command/clearing detected errors
- 5 ESC button: aborts a value, parameter, or menu to return to the previous selection
- 6 Home: root menu
- 7 Turn ±: round scroll navigation, increases or decreases the value, goes to the next or previous line

References

Description	Reference	Weight kg/ lb
Plain text display terminal	VW3A1113	0.200/ 0.441

PF142222

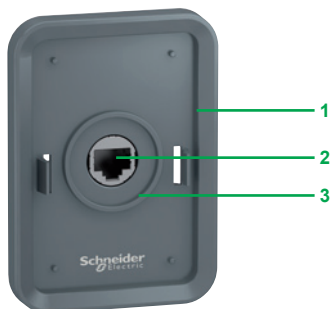

Remote-mounting kit for mounting plain text display terminal on enclosure door (front panel)

PF142251

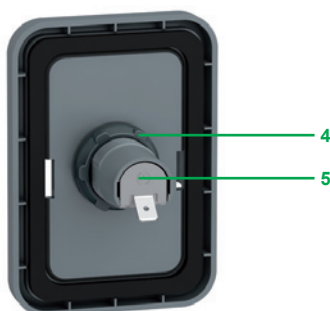

Remote-mounting kit for mounting plain text display terminal on enclosure door (rear panel)

Mounting kit for plain text display terminal

■ Remote-mounting kit for mounting on an enclosure door with IP 43 degree of protection as standard

Description

The kit comprises:

- Tightening tool (also sold separately under the reference ZB5AZ905)

- 1 Mounting plate
- 2 RJ45 port for the plain text display terminal
- 3 Seal
- 4 Fixing nut
- 5 RJ45 port for connecting the remote-mounting cordset

Cordsets should be ordered separately depending on the length required.

Drilling a hole with a standard $\varnothing 22$ tool, as used for a pushbutton, allows the unit to be mounted without the need for a cut-out in the enclosure ($\varnothing 22.5$ mm/ $\varnothing 0.89$ in. drill hole).

An anti-rotation function is provided which works as follows: when the kit is locked on the panel tightly by the nut, the gasket on the back cannot rotate.

References

Description	Length m/ ft	IP degree of protection	Reference	Weight kg/ lb
Remote-mounting kit Order with remote-mounting cordset VW3A1104R●●●	–	43	VW3A1114	–
Tightening tool for remote-mounting kit	–	–	ZB5AZ905	0.016/ 0.035
Remote-mounting cordset equipped with 2 RJ45 connectors	1/ 3.28	–	VW3A1104R10	0.050/ 0.110
	3/ 9.84	–	VW3A1104R30	0.150/ 0.331
	5/ 16.40	–	VW3A1104R50	0.250/ 0.551
	10/ 32.81	–	VW3A1104R100	0.500/ 1.102

PF130899



Graphic display terminal VW3A1111

ATV340_03441_CPSC16025



Detected fault: The screen's red backlight is activated automatically

Graphic display terminal

This terminal can be:

- Connected and mounted on an enclosure door using a remote-mounting accessory
- Connected to a PC to exchange files via a Mini USB/USB connection (1)
- Connected to several drives in multidrop mode (see page 27)

This terminal is used to:

- Control, adjust, and configure the drive
- Display current values (motor, I/O, and machine data)
- Display graphic dashboards such as the energy consumption monitoring dashboard
- Store and download configurations (several configuration files can be stored in the 16 MB memory)
- Duplicate the configuration of one powered-up drive on another powered-up drive
- Copy configurations from a PC or drive and duplicate them on another drive (the drives should be powered on for the duration of the duplication operations)

Other characteristics:

- Up to 24 languages (complete alphabets) covering the majority of countries around the world (languages can be removed, added and updated according to user needs; please consult our website www.schneider-electric.com)
- 2-color backlit display (white and red); if an error is detected, the red backlight is activated automatically (function can be disabled)
- Operating range: -15...50 °C/+5...122 °F
- Degree of protection: IP 65
- Trend curves: Graphic display of changes over time in monitoring variables, energy data, and machine data
- Realtime clock with 10-year backup battery providing data acquisition and event time stamping functions even when the drive is stopped

Description

Display:

- 8 lines, 240 x 160 pixels
- Displays bar charts, gages, and trend charts
- 4 function keys to facilitate navigation and provide contextual links for enabling functions
- STOP/RESET button: Local control of motor stop command/clearing detected errors
- RUN button: Local control of motor run command
- Navigation buttons:
 - OK button: Saves the current value (ENT)
 - Turn ±: Increases or decreases the value, goes to the next or previous line
 - ESC button: Aborts a value, parameter, or menu to return to the previous selection
 - Home: Root menu
 - Information (i): Contextual help

References

Description	Reference	Weight kg/ lb
Graphic display terminal	VW3A1111	0.200/ 0.441

(1) Graphic display terminal used only as a handheld terminal.

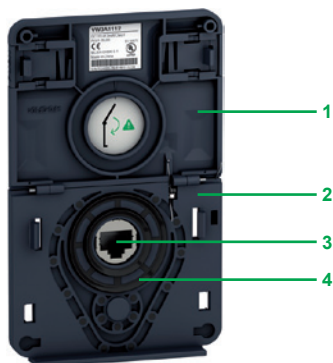

Remote-mounting kit for mounting graphic display terminal on enclosure door (front panel)

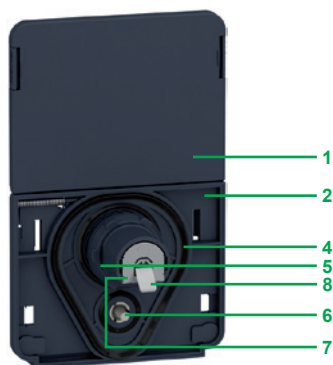

Remote-mounting kit for graphic display terminal (rear panel)

Accessories for graphic display terminal

- Remote-mounting kit for mounting on enclosure door with IP 65/UL Type 12 degree of protection as standard

The kit comprises:

- Tightening tool (also sold separately under the reference ZB5AZ905)

- Cover plate to maintain IP 65 protection when there is no terminal connected
- Mounting plate
- RJ45 port for the graphic display terminal
- Seal
- Fixing nut
- Anti-rotation pin
- RJ45 port for connecting the remote-mounting cordset (10 m/32.81 ft maximum)
Cordsets should be ordered separately depending on the length required.
- Grounding connector

Drilling a hole with a standard $\varnothing 22$ tool, as used for a pushbutton, allows the unit to be mounted without the need for a cut-out in the enclosure ($\varnothing 22.5$ mm/ $\varnothing 0.89$ in. drill hole).

References

Description	Length m/ ft	IP	Reference	Weight kg/ lb
Remote-mounting kit Order with remote-mounting cordset VW3A1104R●●●	–	65/UL Type 12	VW3A1112	–
Tightening tool for remote-mounting kit	–	–	ZB5AZ905	0.016/ 0.035
Remote-mounting cordset equipped with 2 RJ45 connectors	1/ 3.28	–	VW3A1104R10	0.050/ 0.110
	3/ 9.84	–	VW3A1104R30	0.150/ 0.331
	5/ 16.40	–	VW3A1104R50	0.250/ 0.551
	10/ 32.81	–	VW3A1104R100	0.500/ 1.102
IP 65 remote-mounting kit for Ethernet port (1) $\varnothing 22$ RJ45 female/female adapter with seal	–	65	VW3A1115	0.200/ 0.441

Configuration tools

Connection accessories

Description	Reference	Weight kg/ lb
SoMove setup software For configuring, adjusting and debugging the Altivar Machine drive.	(2)	–
USB/RJ45 cable equipped with a USB connector and an RJ45 connector. For connecting a PC to the drive. Length: 2.5 m	TCSMCNAM3M002P	–

Communication accessory

Description	Reference	Weight kg/ lb
IP 20 WiFi dongle Remote mounting of the Ethernet port for connection of WiFi equipment (PC, tablet, smartphone, etc.) powered by internal rechargeable battery	TCSEGWB13FA0	0.350/ 0.772
Modbus/Uni-Telway-Bluetooth® adapter For establishing a Bluetooth® wireless connection between drive and PC equipped with a Bluetooth® wireless link. Pack contents: <ul style="list-style-type: none"> 1 Bluetooth® adapter (range 20 m, class 2) with an RJ45 connector For SoMove: 1 x 0.1 m cordset with 2 RJ 45 connectors (3) 	TCSWAAC13FB	0.032/ 0.071
USB - Bluetooth® adapter for PC Required for a PC which is not equipped with Bluetooth® technology. Connects to a USB port on the PC. Range of 10 m (class 2).	VW3A8115	0.200/ 0.441

(1) Used to connect a remote PC to the RJ45 port on an IP 21 drive mounted in an enclosure or on a wall. Drill hole with a standard $\varnothing 22$ tool, as used for a pushbutton. (Requires remote-mounting cordset VW3A1104R●●● equipped with 2 RJ45 connectors).

(2) See page 21.

(3) Also includes other components for connecting compatible Schneider Electric devices.

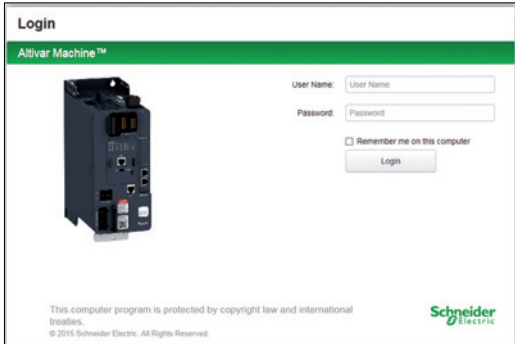

Login screen

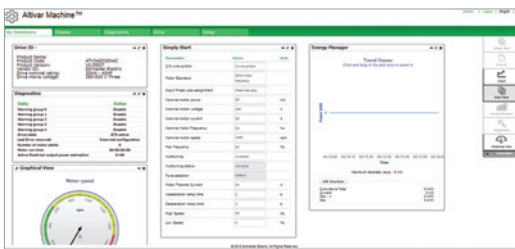

Customizable widgets



Drive parameter tab

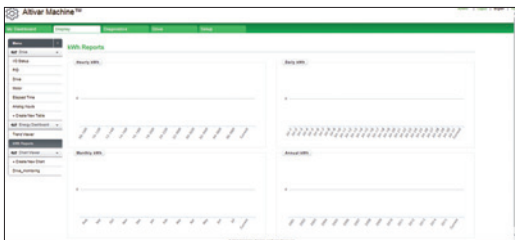

Energy dashboard

Web server

Presentation

- The Web server can only be accessed through Ethernet Embedded drive ATV340●●●N4E
- Connection of a drive that is not a part of an Ethernet network
 - Wired connection via an Ethernet cable through the Ethernet port of the drive
 - Wireless connection via Schneider Electric WiFi dongle, see page 19
- Connection of a drive that is part of an Ethernet network
 - From any point on the network by entering the drive IP address
- The Web server is used for:
 - Commissioning the drive (setting configuration parameters and enabling the main functions)
 - Monitoring energy and machine data, as well as drive and motor data
 - Diagnostics (drive status, file transfer, detected error and warning logs)

Description

The Web server is structured around 5 tabs.

- “My dashboard” tab:
 - Configurable using a wide choice of widgets; groups the information and dashboards selected by the user together on one page
 - Graphics, charts and monitoring tables can be customized to provide a user-friendly interface
- “Display” tab:
 - Monitors energy indicators, efficiency, and performance
 - Displays time stamped application data such as motor current or temperature
 - Monitors drive parameters and status
 - Shows the I/O state and assignment
- “Diagnostics” tab:
 - Drive status
 - Time and date-stamped warning and detected error logs
 - Network diagnostics
 - Access to drive self-tests
- “Drive” tab:
 - Viewing the main drive parameters
 - Editing the main drive parameters
- “Setup” tab:
 - Network configuration
 - Access management
 - Transferring and retrieving drive configurations
 - Exporting data acquisition files and logs
 - Customizing pages (colors, logos, etc.)

Other characteristics:

- Ease of connection via the RJ45 port or WiFi connection
- Password-protected authentication (modifiable password; access rights can be configured by administrator)
- No specific tool required or installation necessary, just connect to the web browser from a drive (through standard Ethernet cable or WiFi dongle)
- Web server can be disabled
- Works in a similar way on PCs, iPhones, iPads, Android systems, and the major web browsers:
 - Internet Explorer® (version 8 or higher)
 - Google Chrome® (version 11 or higher)
 - Mozilla Firefox® (version 4 or higher)
 - Safari® (version 5.1.7 or higher)

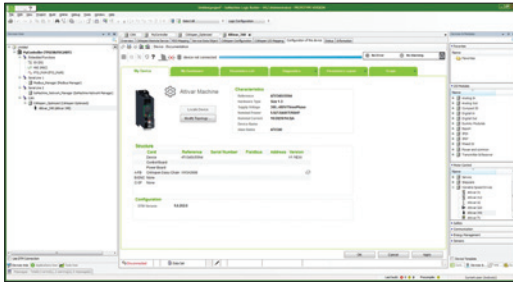

Altivar Machine DTM in SoMachine

DTM

Presentation

Using FDT/DTM technology it is possible to configure, control, and diagnose Altivar Machine drives directly in SoMachine and SoMove software by means of the same software brick (DTM).

FDT/DTM technology standardizes the communication interface between field devices and host systems. The DTM contains a uniform structure for managing drive access parameters.

Specific functions of the Altivar Machine DTM

- Offline or online access to drive data
- Drive firmware updates
- Transferring configuration files from and to the drive
- Customization (dashboard, My Menu, etc.)
- Access to drive parameters and option cards
- Oscilloscope function
- Energy and application data dashboards
- Detected error and warning logs (with time stamping)

Advantages of the DTM in SoMachine:

- Single tool for configuration, setup, and diagnostics
- Network scan for automatic recognition of network configuration in Ethernet architectures (1)
- Ability to add/remove, copy/paste configuration files from other drives in the same architecture
- Single input point for all parameters shared between the PLC (programmable logic controller) and the Altivar Machine drives
- Creation of drive profiles for implicit communication with the PLC as well as dedicated profiles for programs with DFBs (derived function blocks)
- Integration in the fieldbus topology
- Drive configuration is an integral part of the SoMachine project file
- Application function block for SoMachine PLC
- Display visualization blocks for Vijeo Designer

Advantages of the DTM in SoMove:

- Drive-oriented software environment
- Wired connection to the Ethernet communication port
- Standard cable (file transfer performance)

■ Third-party software and downloads:

The Altivar Machine ATV340 DTM is a flexible, open, and interactive tool that can be used in a third-party FDT.

DTMs can be downloaded from our website www.schneider-electric.com.

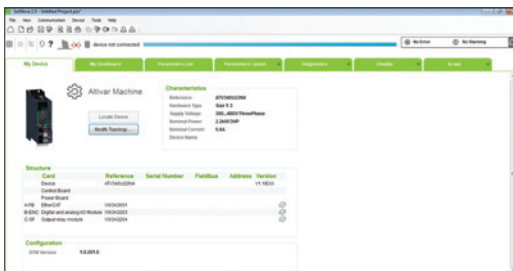

Altivar Machine in SoMove

SoMove software

Presentation

SoMove software for PC is used to configure, set up, and maintain Altivar Machine drives.

In addition to the functions offered by the Web server, SoMove software features the oscilloscope function for accurate display of data samples, as well as access to multi-drive applications.

The software can be connected to Altivar Machine ATV340 variable speed drives via:

- A direct USB/RJ45 cable (Modbus serial) link
- A Bluetooth® wireless connection with the Bluetooth/Modbus adapter

TCSWAAC13FB

- Ethernet Modbus and WiFi connection with the WiFi dongle **TCSEGWB13FA0**
- Ethernet Modbus TCP connection

For more information on SoMove setup software, please consult our “SoMove: Setup Software” catalogue available on our website www.schneider-electric.com.

(1) Only applicable for ATV340 Ethernet drives, ATV340●●●N4E.



SoMove software

Combinations of options for Altivar 340 drives											
Motor		Motor		Drive	Accessories		Options			Line AC chokes (1)	EMC input filters
Heavy Duty		Normal Duty			EMC kit	Push-through flush mounting kit	Braking resistors				
kW	HP	kW	HP				Light cycle	Medium cycle	Severe cycle		
Three-phase supply voltage: 380...480 V 50/60 Hz - Modular drive											
0.75	1	1.1	1.5	ATV340U07N4	VW3A4430	–	VW3A7730	VW3A7740	VW3A7750	VW3A4551	VW3A4422
1.5	2	2.2	3	ATV340U15N4	VW3A4430	–	VW3A7730	VW3A7740	VW3A7750	VW3A4551	VW3A4422
2.2	3	3	3	ATV340U22N4	VW3A4430	–	VW3A7730	VW3A7740	VW3A7750	VW3A4552	VW3A4423
3	3	4	5	ATV340U30N4	VW3A4430	–	VW3A7730	VW3A7740	VW3A7750	VW3A4552	VW3A4423
4	5	5.5	7	ATV340U40N4	VW3A4430	–	VW3A7731	VW3A7741	VW3A7751	VW3A4552	VW3A4423
5.5	7	7.5	10	ATV340U55N4	VW3A4431	–	VW3A7731	VW3A7741	VW3A7751	VW3A4553	VW3A4423
7.5	10	11	15	ATV340U75N4	VW3A4431	–	VW3A7732	VW3A7742	VW3A7752	VW3A4553	VW3A4423
11	15	15	20	ATV340D11N4	VW3A4432	VW3M2606	VW3A7732	VW3A7742	VW3A7752	VW3A4554	VW3A4711
15	20	18.5	25	ATV340D15N4	VW3A4432	VW3M2606	VW3A7733	VW3A7743	VW3A7753	VW3A4554	VW3A4711
18	25	22	30	ATV340D18N4	VW3A4432	VW3M2606	VW3A7733	VW3A7743	VW3A7753	VW3A4555	VW3A4712
22	30	30	40	ATV340D22N4	VW3A4432	VW3M2606	VW3A7733	VW3A7743	VW3A7753	VW3A4555	VW3A4712

Three-phase supply voltage: 380...480 V 50/60 Hz - Ethernet drive											
kW	HP	kW	HP	Drive	Accessories	Push-through flush mounting kit	Options	Options	Options	Line AC chokes (1)	EMC input filters
							Light cycle	Medium cycle	Severe cycle		
0.75	1	1.1	1.5	ATV340U07N4E	VW3A4430	–	VW3A7730	VW3A7740	VW3A7750	VW3A4551	VW3A4422
1.5	2	2.2	3	ATV340U15N4E	VW3A4430	–	VW3A7730	VW3A7740	VW3A7750	VW3A4551	VW3A4422
2.2	3	3	3	ATV340U22N4E	VW3A4430	–	VW3A7730	VW3A7740	VW3A7750	VW3A4552	VW3A4423
3	3	4	5	ATV340U30N4E	VW3A4430	–	VW3A7730	VW3A7740	VW3A7750	VW3A4552	VW3A4423
4	5	5.5	7	ATV340U40N4E	VW3A4430	–	VW3A7731	VW3A7741	VW3A7751	VW3A4552	VW3A4423
5.5	7	7.5	10	ATV340U55N4E	VW3A4431	–	VW3A7731	VW3A7741	VW3A7751	VW3A4553	VW3A4423
7.5	10	11	15	ATV340U75N4E	VW3A4431	–	VW3A7732	VW3A7742	VW3A7752	VW3A4553	VW3A4423
11	15	15	20	ATV340D11N4E	VW3A4432	VW3M2606	VW3A7732	VW3A7742	VW3A7752	VW3A4554	VW3A4711
15	20	18.5	25	ATV340D15N4E	VW3A4432	VW3M2606	VW3A7733	VW3A7743	VW3A7753	VW3A4554	VW3A4711
18	25	22	30	ATV340D18N4E	VW3A4432	VW3M2606	VW3A7733	VW3A7743	VW3A7753	VW3A4555	VW3A4712
22	30	30	40	ATV340D22N4E	VW3A4432	VW3M2606	VW3A7733	VW3A7743	VW3A7753	VW3A4555	VW3A4712
30	40	37	50	ATV340D30N4E	–	NSYPTDS4	VW3A7734	VW3A7744	VW3A7754	–	VW3A4706
37	50	45	60	ATV340D37N4E	–	NSYPTDS4	VW3A7734	VW3A7744	VW3A7754	–	VW3A4706
45	60	55	75	ATV340D45N4E	–	NSYPTDS5	VW3A7735	VW3A7745	VW3A7755	–	VW3A4707
55	75	75	100	ATV340D55N4E	–	NSYPTDS5	VW3A7736	VW3A7746	VW3A7756	–	VW3A4708
75	100	90	125	ATV340D75N4E	–	NSYPTDS5	VW3A7736	VW3A7746	VW3A7756	–	VW3A4708
Pages				12	13	13	32	33	33	36	35

I/O expansion modules		
Description	Reference	Page
Module with digital and analog I/O	VW3A3203	25
Module with relay outputs	VW3A3204	25

Encoder interface modules		
Description	Reference	Page
Digital interface encoder module	VW3A3420	24
Analog interface encoder module	VW3A3422	24
Resolver interface module	VW3A3423	24

List of fieldbus modules		
Description	Reference	Page
CANopen Daisy chain	VW3A3608	29
CANopen SUB-D	VW3A3618	29
CANopen screw terminal block	VW3A3628	30
PROFINET	VW3A3627	31
PROFIBUS DP V1	VW3A3607	31
DeviceNet	VW3A3609	31

Module compatibility table			
Module type (2)	Modular drive and Ethernet drive GP-SF slot SlotC (3)	Modular drive and Ethernet drive GP-ENC SlotB (3)	Modular drive GP-FB slot SlotA (3)
Digital and analog I/O VW3A3203			
Relay outputs VW3A3204			
Fieldbuses VW3A3608, VW3A3618, VW3A3628, VW3A3607, VW3A3609, VW3A3601, VW3A3619, VW3A3627			
Encoder interface modules VW3A3420, VW3A3422 and VW3A3423			

 Combination possible

 Combination impossible

(1) Line choke listed is chosen based on heavy duty mode of each drive. For more details, please see page 36.
 (2) 2 modules of the same type cannot be inserted in the Altivar Machine ATV340 variable speed drives simultaneously.
 (3) SlotA, SlotB, SlotC are the markings on the ATV340D30...D75N4E drives.



Embedded encoder interface



VW3A3422 analog interface encoder module



VW3A3423 resolver interface encoder module



VW3A3420 digital interface encoder module 5/12 V

Presentation

Altivar Machine ATV340 variable speed drives from ATV340U07...D22N4● have an on-board encoder interface. The on-board encoder interface 1 supports RS422 for A/B/I incremental and 1 Vpp for sin/cos signals.

References from ATV340D30N4E...D75N4E do not have an on-board encoder interface, however optional encoder modules can be used for Flux Vector Control operation with sensor (FVC mode) for asynchronous motors, or for Vector Control operation with speed feedback (FSY mode) for synchronous motors.

They improve drive performance irrespective of the motor load state:

- Zero speed torque
- Accurate speed regulation
- Torque accuracy
- Shorter response times on a torque surge
- Improved dynamic performance in transient state

For asynchronous motors, encoder interface modules improve static speed accuracy in different control modes (voltage vector control, voltage/frequency ratio).

Depending on the model, encoder interface modules can also be used for monitoring, irrespective of the control type:

- Overspeed detection
- Load slipping detection

They can also transmit a reference value provided by the encoder input to the Altivar variable speed drive. This specific feature is used to synchronize the speed of several drives. The encoder options have a thermal sensor input to monitor one standard temperature sensor.

3 modules are available depending on the encoder technology:

- Resolver encoder
- Encoder with digital output
- Encoder with analog output

The Altivar variable speed drive can only be equipped with one of the encoder interface modules. The interface encoder module is inserted in a dedicated slot (see page 23).

It is protected against encoder supply short circuits and overloads.

References

Description	Technology type	Used with encoder (1)	Power supply	Maximum current	Maximum cable length	Maximum operating frequency	Supported thermal sensors	Reference	Weight
			V ~	mA	m/ft	kHz			kg/lb
Resolver interface encoder module	Resolver	–	–	50	100/328	3...12	PTC (digital/linear), PT100, PT1000, Klixon	VW3A3423	0.150/ 0.331
Digital interface encoder module 5/12 V	A/B/I	XCC1●●●●●●R XCC1●●●●●●X	5, 12 or 24	250, 100	100/328	1,000	PTC (digital/linear), PT100, PT1000, Klixon	VW3A3420	0.150/ 0.331
	SSI	XCC2●●●●●●S●● XCC3●●●●●●S●●	5, 12 or 24	250, 100	50/164 (2)	1,000 (2)			
	EnDat® 2.2		5, 12 or 24	250, 100	50/164 (2)	1,000 (2)			
Analog interface encoder module	1 Vpp		5, 12 or 24	250, 100	100/328	100	PTC (digital/linear), PT100, PT1000, Klixon	VW3A3422	0.150/ 0.331
	SinCos Hiperface®		5, 12 or 24	250, 100	100/328	100			

Connection accessories (3)

Description	Composition	Length m/ft	Reference	Weight kg/lb
Cordset				
Cordset equipped with 1 x 15-way high density male SUB-D connector for digital or analog encoder modules	–	1/3.28	VW3M4701	–
Connecting cable				
Cable for creating cordsets for encoder interface modules	3 x (2 x 0.14 mm ² /AWG 26) + 2 x (2 x 0.34 mm ² /AWG 22)	25/82.02	VW3M8222R250	1.400/ 3.086
		50/164.04	VW3M8222R500	2.800/ 6.173
		100/328.08	VW3M8222R1000	5.600/ 12.346
	5 x (2 x 0.25 mm ² /AWG 24) + 1 x (2 x 0.5 mm ² /AWG 20)	100/328	VW3M8221R1000	21.000/ 46.297

(1) To determine the complete reference, please refer to the "Detection automation solutions - OsiSense" catalog or our website www.schneider-electric.com.

(2) With propagation delay compensation on EnDat® up to 100 m/328 ft and higher maximum frequencies possible, SSI 300 kHz up to 100 m/328 ft possible.

(3) See the complete list of connection accessories on our website www.schneider-electric.com.

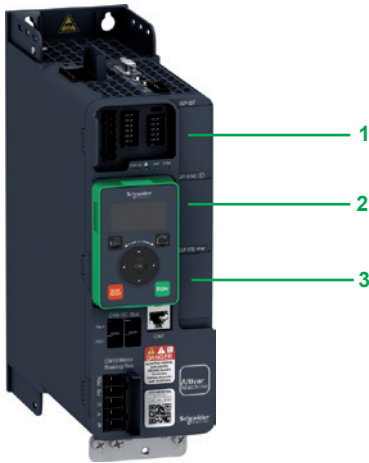

PF140391/B



VW3A3203

PF130897/B



VW3A3204

I/O expansion modules

Presentation

By installing I/O expansion modules Altivar Machine drives can be adapted to meet the needs of applications that manage additional sensors or specific sensors.

2 extension modules are available:

- Module with digital and analog I/O
- Module with relay outputs

These modules are inserted in slots 1 and 2 on Altivar Machine drives:

- 1 GP-SF slot for I/O expansion or safety functions modules
- 2 GP-ENC slot for I/O expansion or encoder modules
- 3 GP-FB slot for I/O expansion or communication option modules

Module with digital and analog I/O

- 2 differential analog inputs configurable via software as current (0-20 mA/4-20 mA), or for PTC, PT100, or PT1000, 2 or 3-wire
- 14-bit resolution
- 6 x 24 V $\overline{\text{V}}$ positive or negative digital inputs
- Sampling: 1 ms max
- 2 assignable digital outputs
- 2 removable spring terminal blocks

Module with relay outputs

- 3 relay outputs with NO contacts
- 1 fixed screw terminal block

I/O expansion modules

Description	I/O type				Reference	Weight kg/lb
	Digital inputs	Digital outputs	Analog inputs	Relay outputs		
Module with digital and analog I/O	6	2	2 (1)	–	VW3A3203	–
Module with relay outputs	–	–	–	3 (2)	VW3A3204	–

(1) Differential analog inputs configurable via software as current (0-20 mA/4-20 mA), or for PTC, PT100, or PT1000, 2 or 3-wire. When configured as PTC probe inputs, they must never be used to protect an ATEX motor in applications in explosive atmospheres. Please refer to the ATEX guide on our website www.schneider-electric.com.

(2) NO contacts.

Note: Digital and analog I/O expansion modules and relay output modules can be placed in slot A or slot B for reference ATV340D30...D75N4E on Altivar Machine ATV340 variable speed drives. For more details, please refer to the installation manual.

2 modules of the same type cannot be inserted in Altivar Machine ATV340 variable speed drives.

Variable speed drives

Altivar Machine ATV340

Communication buses and networks

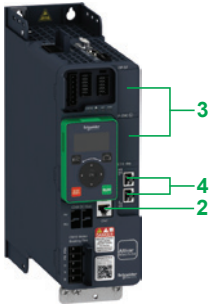

ATV340 Ethernet drive equipped with plain text display terminal

Presentation

Altivar Machine ATV340 drives are designed to meet configuration requirements found in the main industrial communication installations. ATV340 variable speed drives have a Modbus serial line port **2** as standard, a single port for connecting the display and a single port for connection to the configuration tool. Moreover, "ATV340●●●N4E" Ethernet-type drives are equipped with multi-Ethernet protocol. Ethernet IP and Modbus TCP are available as standard with dual RJ45 ports **4**.

Modbus serial link

There are two ports using Modbus RTU protocol for connecting to the HMI, and commissioning.

The HMI serial link port **1** is designed for simple integration of the Magelis HMI terminal:

- Magelis HMI terminal
- Remote display terminal, remote graphic display terminal

The commissioning port **2** is used to configure the parameters or monitor the status of the variable speed drive, using the following methods:

- SoMove setup software

Dual port multi-Ethernet communication

Altivar Machine ATV340 Ethernet drives integrate the EtherNet/IP and Modbus TCP communication protocols as standard.

- EtherNet/IP and Modbus TCP dual port **4**

This offers the standard services regularly used in industrial networks: connection to the Modbus TCP or EtherNet/IP network

- EtherNet IP adapter including standard CIP objects (AC/DC drive objects, CIP energy objects, etc.), compliant with ODVA specification
 - The RSTP connection allows ring topology to help ensure continuity of service.
 - The dual port allows daisy chain connection to simplify cabling and network infrastructure (no need to use a switch).
 - Modbus TCP message handling is based on the Modbus protocol and is used to exchange process data with other network devices (e.g., a PLC). It provides ATV340E drives with access to the Modbus protocol and to the high performance of the Ethernet network, which is the communication standard for numerous devices.
 - SNMP (Simple Network Management Protocol) offers standard diagnostics services for network management tools.
 - The FDR (Fast Device Replacement) service allows automatic reconfiguration of a new device installed to replace an existing device.
 - Device security is reinforced by disabling some unused services as well as managing a list of authorized devices.
 - Setup and adjustment tools (SoMove, SoMachine with DTM) can be connected locally or remotely.
 - The embedded Web server is used to display operating data and dashboards as well as to configure and diagnose system elements from any web browser.
- These numerous services offered by Altivar Machine ATV340E drives simplify integration into Schneider Electric machine automation controllers such as M241 and M251.

Communication modules for industrial applications

The following communication modules are available as options:

- CANopen
- PROFIBUS DP V1
- DeviceNet
- EtherCAT
- ProfiNet

Description

Altivar Machine ATV340 drives have been designed to simplify connections to communication buses and networks by means of the following:

- 1** Integrated RJ45 communication port for HMI on the front
- 2** Integrated RJ45 communication port for Modbus on the front
- 3** Slots available for the I/O extension modules, encoder modules and safety functions module (see page 23)
- 4** Integrated RJ45 dual communication port for Ethernet for ATV340 Ethernet drives, ATV340●●●N4E
- 5** Slots available to insert communication modules for ATV340 modular drives, ATV340●●●N4

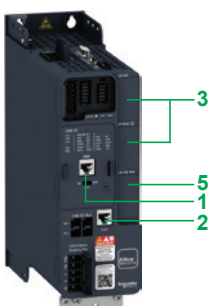

ATV340 modular drive

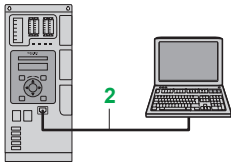

ATV340 Modular drive using Modbus to connect drive with the basic display terminal and PC

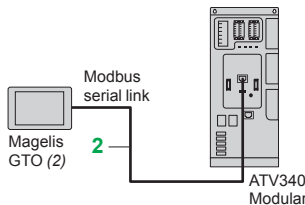

Example of connecting a modular ATV340 drive to a Magelis GTO HMI terminal via the Modbus serial link

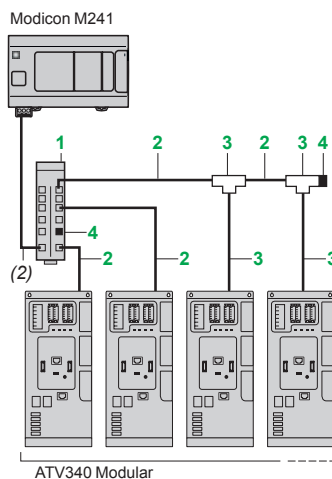

Example of Modbus diagram with connection via splitter box and RJ45 connectors

Functions

Altivar Machine ATV340 drive functions can be accessed via the communication buses and networks:

- Control
- Monitoring
- Adjustment
- Configuration

The speed reference and command may come from different sources:

- Digital input or analog I/O terminals
- Communication bus or network
- Remote/Local display terminals
- PTI interface (1)

As one of the advanced functions, the control sources of ATV340 drive can be managed and switched according to the application requirements.

The communication periodic I/O data assignment can be selected using the network configuration software.

The ATV340 drive can be controlled:

- According to the CiA 402 native profile
- According to the I/O profile

Communication is monitored according to criteria specific to each protocol.

Regardless of protocol type, the reaction of the drive to a detected communication interruption can be configured as follows:

- Freewheel stop, stop on ramp, fast stop, or braked stop
- Maintain the last command received
- Fallback position at a predefined speed
- Ignore the detected error

Modbus serial link

Connection accessories for remote Human Machine Interface (2)

Description	Item no.	Length m/ft	Reference	Weight kg/lb
Modbus splitter box 10 RJ45 connectors and 1 screw terminal block	1	-	LU9GC3	0.500/ 0.110
Cordsets for Modbus serial link equipped with 2 RJ45 connectors	2	0.3/0.98	VW3A8306R03	0.025/ 0.055
		1.0/3.28	VW3A8306R10	0.060/ 0.132
		3.0/9.84	VW3A8306R30	0.130/ 0.287
Modbus T-junction boxes (with integrated cable)	3	0.3/0.98	VW3A8306TF03	0.190/
		1.0/3.28	VW3A8306TF10	0.210/
Line terminators for RJ45 connector Set of 2 (3)	4	R = 120 Ω	VW3A8306RC	0.020/ 0.044
		R = 150 Ω	VW3A8306R	0.020/ 0.044

(1) PTI interface is available for ATV340U07...D22N4 drives.

(2) See page 16 for connection of a remote display terminal or remote graphic display terminal.

(3) Requires a 24 V DC power supply. Please refer to the "Human/Machine interfaces" catalogue.

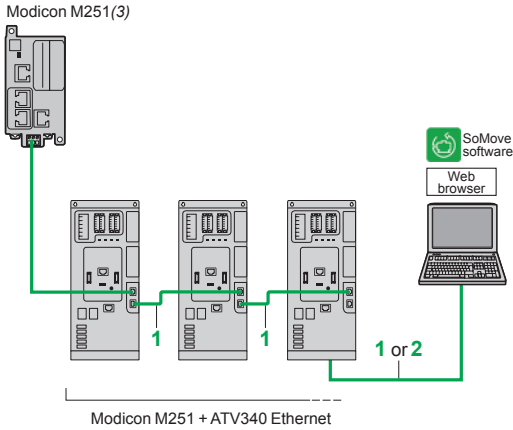

Example of connection on an EtherNet/IP network

Modbus TCP network and EtherNet/IP network

Description	Item no.	Length m/ft (2)	Reference	Weight kg/lb
ConneXium cordsets (1) (2)				
Straight shielded twisted pair cordsets	1	2.0/ 6.56	490NTW00002	—
equipped with 2 RJ45 connectors		5.0/ 16.40	490NTW00005	—
Conforming to EIA/TIA-568 category 5 and IEC 11801/EN 50173-1, class D standards		12/ 39.37	490NTW00012	—
Crossed shielded twisted pair cordsets	2	5.0/ 16.40	490NTC00005	—
equipped with 2 RJ45 connectors		15/ 49.21	490NTC00015	—
Conforming to EIA/TIA-568 category 5 and IEC 11801/EN 50173-1, class D standards				
Straight shielded twisted pair cordsets	1	2.0/ 6.56	490NTW00002U	—
equipped with 2 RJ45 connectors		5.0/ 16.40	490NTW00005U	—
Conforming to UL and CSA 22.1 standards		12/ 39.37	490NTW00012U	—
Crossed shielded twisted pair cordsets	2	5.0/ 16.40	490NTC00005U	—
equipped with 2 RJ45 connectors		15/ 49.21	490NTC00015U	—
Conforming to UL and CSA 22.1 standards				

(1) For other ConneXium connection accessories, please refer to our website www.schneider-electric.com.

(2) Also available in 40 m/131.23 ft and 80 m/262.46 ft lengths (1).

(3) Please refer to the "M241/M251 Automation platform" catalogue.

Variable speed drives

Altivar Machine ATV340

Communication buses and networks



VW3A3608

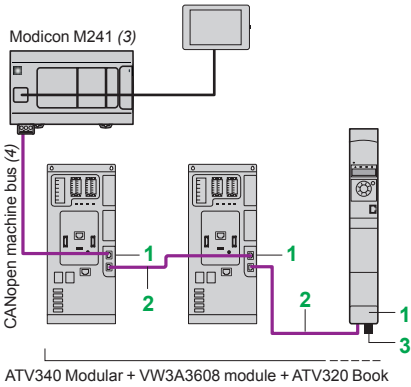

ATV340 Modular + VW3A3608 module + ATV320 Book



VW3A3618

CANopen machine bus

Description	Item no.	Length m/ft	Unit reference	Weight kg/lb
Connection with VW3A3608 CANopen daisy chain module (optimized solution for daisy chain connection to the CANopen machine bus)				
CANopen daisy chain communication module Ports: 2 RJ45 connectors	1	–	VW3A3608	–
CANopen cordsets equipped with 2 RJ45 connectors	2	0.3/ 0.98 1.0/ 3.28	VW3CANCARR03 VW3CANCARR1	0.050/ 0.110 0.500/ 1.102
CANopen line terminator for RJ45 connector	3	–	TCSCAR013M120	–
CANopen terminal adapter 2 RJ45 connectors for daisy-chain connection		0.3/ 0.98	TCSCCTN023F13M03	–
Connection via SUB-D connector with VWA3618 CANopen module				
CANopen communication module Port: 1 x 9-way male SUB-D connector		–	VW3A3618	–
CANopen cable Standard cable, CE marking Low smoke zero halogen Flame retardant (IEC 60332-1)		50/ 164.04 100/ 328.08 300/ 984.25	TSXCANCA50 TSXCANCA100 TSXCANCA300	4.930/ 10.869 8.800/ 19.401 24.560/ 54.145
CANopen cable Standard cable, UL certification, CE marking Flame retardant (IEC 60332-2)		50/ 164.04 100/ 328.08 300/ 984.25	TSXCANCB50 TSXCANCB100 TSXCANCB300	3.580/ 7.892 7.840/ 17.284 21.870/ 48.215
CANopen cable Cable for harsh environments (1) or mobile installations, CE marking Low smoke zero halogen Flame retardant (IEC 60332-1)		50/ 164.04 100/ 328.08 300/ 984.25	TSXCANCD50 TSXCANCD100 TSXCANCD300	3.510/ 7.738 7.770/ 17.130 21.700/ 47.840
CANopen bus connector with line terminator - one 9-way female SUB-D connector		–	VW3M3802	–
CANopen connector SUB-D9 with line terminator (can be disabled). 180° cable outlet for 2 CANopen cables. CAN-H, CAN-L, CAN-GND connection.		–	VW3CANKCDF180T	–
CANopen IP 20 straight connector SUB-D9 with line terminator (can be deactivated)		–	TSXCANKCDF180T	0.049/ 0.108
IP 20 CANopen right angle connector (2) SUB-D9 with line terminator (can be deactivated)		–	TSXCANKCDF90T	0.046/ 0.101

(1) Standard environment:

- No particular environmental constraints
- Operating temperature between 5 and 60 °C/41 and 140 °F
- Fixed installation

Harsh environment:

- Resistance to hydrocarbons, industrial oils, detergents, solder splashes
- Relative humidity up to 100%
- Saline atmosphere
- Operating temperature between -10 and +70 °C/14 and 158 °F
- Significant temperature variations

(2) Incompatible with side-by-side mounting.

(3) Please refer to the "Modicon M241 logic controller", "Modicon M251 logic controller", and "Magelis SCU small HMI controllers" catalogues.

(4) Cable dependent on the type of controller or PLC; please refer to the corresponding catalogue.

Variable speed drives

Altivar Machine ATV340

Communication buses and networks

PF098129

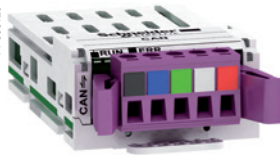

VW3A3628

CANopen machine bus (continued)

Description	Length m/ft	Unit reference	Weight kg/lb
-------------	----------------	-------------------	-----------------

Connection via terminals with VW3A3628 CANopen module

CANopen communication module Port: 1 x 5-way screw terminal block	–	VW3A3628	–
CANopen line terminator for screw terminal connector	–	TCSCAR01NM120	–

Other connection accessories and cordsets

IP 20 CANopen cordsets equipped with 2 x 9-way female SUB-D connectors. Standard cable, C€ marking Low smoke zero halogen Flame retardant (IEC 60332-1)	0.3/	TSXCANCADD03	0.091/
	0.98		0.201
	1.0/	TSXCANCADD1	0.143/
	3.28		0.315
	3.0/	TSXCANCADD3	0.295/
	9.84		0.650
	5.0/	TSXCANCADD5	0.440/
	16.40		0.970

IP 20 CANopen cordsets equipped with 2 x 9-way female SUB-D connectors. Standard cable, UL certification, C€ marking Flame retardant (IEC 60332-2)	0.3/	TSXCANCBDD03	0.086/
	0.98		0.190
	1.0/	TSXCANCBDD1	0.131/
	3.28		0.289
	3.0/	TSXCANCBDD3	0.268/
	9.84		0.591
	5.0/	TSXCANCBDD5	0.400/
	16.40		0.882

CANopen terminal adapter 2 spring terminals for daisy chain connection	0.6/ 1.96	TCSCTN026M16M	–
--	--------------	----------------------	---

IP 20 CANopen junction boxes equipped with: ■ 4 x 9-way male SUB-D connectors + screw terminal block for trunk cable tap link ■ Line terminator	–	TSXCANTDM4	0.196/ 0.432
---	---	-------------------	-----------------

IP 20 CANopen junction boxes equipped with: ■ 2 screw terminal blocks for trunk cable tap link ■ 2 RJ45 connectors for connecting drives ■ 1 RJ45 connector for connecting a PC	–	VW3CANTAP2	0.480/ 1.058
--	---	-------------------	-----------------

Variable speed drives

Altivar Machine ATV340

Communication buses and networks

PF096130



VW3A3607

PROFIBUS DP V1 bus

Description	Reference	Weight kg/lb
PROFIBUS DP V1 communication module Port: 1 x 9-way female SUB-D connector Conforming to PROFIBUS DP V1 Profiles supported: ■ CiA 402 drive ■ Profidrive Offers several message handling modes based on DP V1	VW3A3607	0.140/ 0.308

PF096140

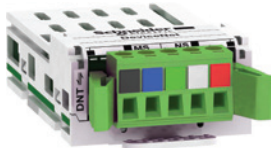

VW3A3609

DeviceNet bus

Description	Reference	Weight kg/lb
DeviceNet communication module Port: 1 removable 5-way screw connector Profiles supported: ■ CIP AC DRIVE ■ CiA 402 drive	VW3A3609	–

PF102282



VW3A3601

EtherCAT bus

Description	Reference	Weight kg/lb
EtherCAT communication module Port: 2 RJ45 connectors	VW3A3601	–

PF130613



VW3A3627

ProfiNet network

Description	Reference	Weight kg/lb
ProfiNet communication module Port: 2 RJ45 connectors	VW3A3627	0.300/ 0.660

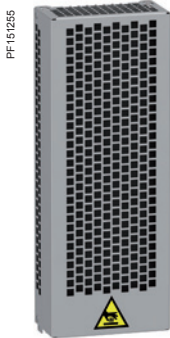

VW3A7741

Presentation

Braking resistors allow Altivar Machine ATV340 drives to operate while braking to a standstill, by dissipating the braking energy. They enable maximum transient braking torque.

Braking resistors are designed to be located outside the enclosure, but should not inhibit natural cooling. Air inlets and outlets must not be obstructed in any way. The air should be free of dust, corrosive gas, and condensation.

The internal circuits of Altivar Machine drives have a built-in dynamic braking transistor. Depending on the drive rating, the enclosed external braking resistor with IP20 and IP 23 is designed to comply with the EMC standard and monitored by a temperature-controlled switch or thermal overload relay.

Applications

Braking resistors are designed for a defined cycle (see the 3 cycle types defined below). Depending on your own applications and cycles, you can use these resistors or define a new value.

- Braking resistors for light braking cycles for machines with cycles and inertia. The braking power is limited to 1.5 Tn for 0.8 s every 40 s.
- Braking resistors for medium braking cycles for machines with high inertia and conveyors. The braking power is limited to 1.35 Tn for 4 s every 40 s.
- Braking resistors for severe braking cycles for machines with very high inertia and vertical movements (hoisting). The braking power is limited to 1.65 Tn for 6 s and Tn for 54 s every 120 s.

Below are the list of the associated braking resistors according to the required braking cycle (1).

References for a light braking cycle

For drives	Degree of protection of the resistor	Ohmic value at 20 °C/ 68 °F	Average power available at 50 °C/ 122 °F (2)	Quantity required per drive	Reference	Weight
		Ω	kW			kg/lb
Supply voltage: 380...480 V 50/60 Hz						
ATV340U07...U30N4 ATV340U07...U30N4E	IP20	100	0.1	1	VW3A7730	1.500/ 3.307
ATV340U40...U55N4 ATV340U40...U55N4E	IP20	60	0.16	1	VW3A7731	2.000/ 4.409
ATV340U75...D11N4 ATV340U75...D11N4E	IP20	28	0.3	1	VW3A7732	3.000/ 6.614
ATV340D15...D22N4 ATV340D15...D22N4E	IP20	16	1.1	1	VW3A7733	4.000/ 8.818
ATV340D30...D37N4E	IP20	10	1.1	1	VW3A7734	5.500/ 12.125
ATV340D45N4E	IP20	8	1.1	1	VW3A7735	5.500/ 12.125
ATV340D55...D75N4E	IP23	5	1.9	1	VW3A7736	18.000/ 39.683

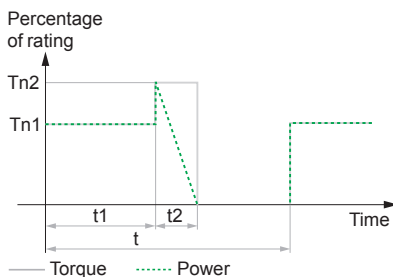

Light Cycle

$t = 40 \text{ s}$	t : period
$t1 = 0 \text{ s}$	$Tn1$: braking torque
$t2 = 0.8 \text{ s}$	$Tn2$: braking torque
$Tn1 = 0$	Tn : nominal torque
$Tn2 = 1.5 \times Tn$	

(1) The minimum braking resistor ohmic value of the drive can be found in the installation manual. For more information, please visit our website: www.schneider-electric.com.

(2) Load factor for resistors: The value of the average power that can be dissipated at 50 °C/122 °F from the resistor into the casing is determined for a load factor during braking that corresponds to the majority of normal applications:

- Normal duty: 0.8 s braking with a 1.2 Tn braking torque for a 40 s cycle
- Heavy duty: 0.8 s braking with a 1.5 Tn braking torque for a 40 s cycle

Variable speed drives

Altivar Machine ATV340

Option: Braking resistors

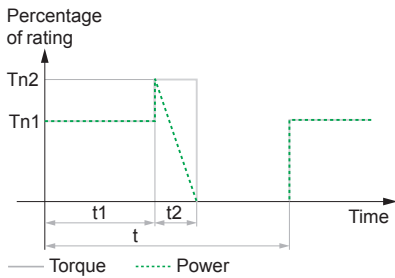

Medium Cycle	
$t = 40\text{ s}$	t : period
$t1 = 0\text{ s}$	$Tn1$: braking torque
$t2 = 4\text{ s}$	$Tn2$: braking torque
$Tn1 = 0$	Tn : nominal torque
$Tn2 = 1.35 \times Tn$	

References for a medium braking cycle

For drives	Degree of protection of the resistor	Ohmic value at 20 °C/ 68 °F	Average power available at 50 °C/ 122 °F (1)	Quantity required per drive	Reference	Weight
		Ω	kW			kg/lb
Supply voltage: 380...480 V 50/60 Hz						
ATV340U07N4 ATV340U07N4E	IP20	100	0.1	1	VW3A7730	1.500/ 3.307
ATV340U15...U30N4 ATV340U15...U30N4E	IP20	100	0.26	1	VW3A7740	2.500/ 5.512
ATV340U40...U55N4 ATV340U40...U55N4E	IP20	60	0.5	1	VW3A7741	4.500/ 9.921
ATV340U75...D11N4 ATV340U75...D11N4E	IP20	28	1.1	1	VW3A7742	4.000/ 8.818
ATV340D15...D22N4 ATV340D15...D22N4E	IP20	16	2.2	1	VW3A7743	7.000/ 15.432
ATV340D30...D37N4E	IP20	10	3.4	1	VW3A7744	11.500/ 25.353
ATV340D45N4E	IP23	8	3.8	1	VW3A7745	23.000/ 50.706
ATV340D55...D75N4E	IP23	5	6.9	1	VW3A7746	27.000/ 59.525

References for a severe braking cycle (hoisting applications)

For drives	Degree of protection of the resistor	Ohmic value at 20 °C/ 68 °F	Average power available at 50 °C/ 122 °F (2)	Quantity required per drive	Reference	Weight
		Ω	kW			kg/lb
Supply voltage: 380...480 V 50/60 Hz						
ATV340U07...U30N4 ATV340U07...U30N4E	IP20	100	1.7	1	VW3A7750	5.500/ 12.125
ATV340U40...U55N4 ATV340U40...U55N4E	IP20	60	3.4	1	VW3A7751	10.000/ 22.046
ATV340U75...D11N4 ATV340U75...D11N4E	IP23	28	5.1	1	VW3A7752	25.000/ 55.116
ATV340D15...D22N4 ATV340D15...D22N4E	IP23	16	14	1	VW3A7753	47.000/ 103.617
ATV340D30...D37N4E	IP23	10	19	1	VW3A7754	67.000/ 147.710
ATV340D75N4E	IP23	10	19	2		
ATV340D45N4E	IP23	8	25	1	VW3A7755	86.000/ 189.597
ATV340D55N4E	IP23	5	32	1	VW3A7756	120.000/ 264.554

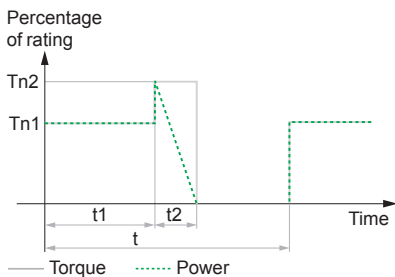

Severe Cycle	
$t = 120\text{ s}$	t : period
$t1 = 54\text{ s}$	$Tn1$: braking torque
$t2 = 6\text{ s}$	$Tn2$: braking torque
$Tn1 = Tn$	Tn : nominal torque
$Tn2 = 1.65 \times Tn$	

(1) Load factor for resistors: The value of the average power that can be dissipated at 50 °C/122 °F from the resistor into the casing is determined for a load factor during braking that corresponds to the majority of normal applications:

- Normal duty: 4 s braking with a 1.35 Tn braking torque for a 40 s cycle
- Heavy duty: 4 s braking with a 1.65 Tn braking torque for a 40 s cycle

(2) Load factor for resistors: The value of the average power that can be dissipated at 50 °C/122 °C from the resistor into the casing is determined for a load factor during braking that corresponds to the majority of normal applications:

- Heavy duty: 54 s braking with a 1 Tn braking torque and 6 s braking with a 1.65 Tn braking torque for a 120 s cycle

Variable speed drives

Altivar Machine ATV340

Integrated EMC filters and additional EMC input filters

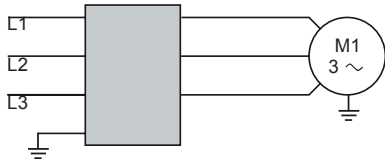

ATV340●●●N4
ATV340●●●N4E
with integrated filter

Altivar Machine drive ATV340 with integrated EMC filter

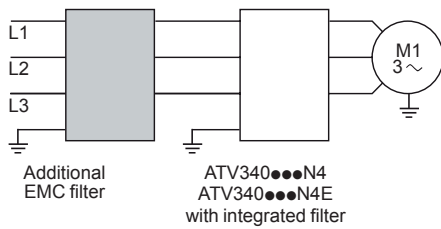

Additional
EMC filter
ATV340●●●N4
ATV340●●●N4E
with integrated filter

Integrated EMC filters

Altivar Machine ATV340 drives have integrated radio interference input filters to comply with the EMC (Electromagnetic Compatibility) standard for variable speed electrical power drive products IEC 61800-3 category C2 or C3 and the European EMC Directive.

The integrated EMC filters comply with standard IEC 61800-3 for a maximum motor cable length listed below:

For drives	Maximum length of shielded cable acc. to	
	IEC/EN 61800-3 category C2	IEC/EN 61800-3 category C3
	m	m
Three-phase supply voltage: 380...480 V IP 20		
ATV340U07...D22N4	–	20
ATV340U07...D22N4E	–	20
ATV340D30...D37N4E	50	100
ATV340D45...D75N4E	–	100

Additional EMC input filters

The additional EMC input filters enable the drives to meet more stringent requirements; they are designed to reduce conducted emissions on the supply mains below the limits of standard IEC 61800-3 category C2 or C3 (see page 35).

Mounting on ATV340●●●N4/N4E

Depending on the model, additional EMC filters can be mounted beside or underneath the drive.

Mounting the filter on the side of the drive: ATV340U07...U75N4● drives

Mounting the filter underneath the drive: ATV340D11...D22N4, ATV340D11...D75N4E drives

Use according to the type of supply mains

Additional EMC filters can only be used on TN (neutral connection) and TT (grounded neutral) type systems.

Standard IEC 61800-3, appendix D2.1, states that on IT systems (isolated or impedance grounded neutral), filters can cause permanent insulation monitors to operate in a random manner.

The effectiveness of additional filters on this type of system depends on the type of impedance between neutral and ground, and therefore cannot be predicted.

If a machine has to be installed on an IT system, one solution is to insert an isolation transformer and connect the machine locally on a TN or TT system.

Note:

ATV340U07...D22N4, ATV340U07...D37N4E drives are compatible to be used with maximum 100 m/328.08 ft shielded motor cable length with 4kHz switching frequency.

ATV340D37...D75N4E drives are compatible to be used with maximum 100 m/328.08 ft shielded motor cable length with 2.5kHz switching frequency.



VW3A4422



VW3A4706

References						
For drives	Additional EMC input filter					
Reference	Maximum length of shielded cable (1) (2)	In (3)	Losses (4)	Filter mounted	Reference	Weight
	IEC 61800-3 (5)					
	Category C2	Category C3				
	m/ft	m/ft	A	W		kg/lb
Three-phase supply voltage: 380...480 V 50/60 Hz						
ATV340U07N4E, ATV340U07N4	50/ 164.04	100/ 328.08	15	9.9	On the side	VW3A4422 0.600/ 1.323
ATV340U15N4E, ATV340U15N4						
ATV340U22N4E, ATV340U22N4	50/ 164.04	100/ 328.08	25	15.8	On the side	VW3A4423 0.775/ 1.709
ATV340U30N4E, ATV340U30N4						
ATV340U40N4E, ATV340U40N4						
ATV340U55N4E, ATV340U55N4						
ATV340U75N4E, ATV340U75N4						
ATV340D11N4E, ATV340D11N4	50/ 164.04	100/ 328.08	50	8	On the side	VW3A4711 5.200/ 11.464
ATV340D15N4E, ATV340D15N4						
ATV340D18N4E, ATV340D18N4	50/ 164.04	100/ 328.08	70	10	On the side	VW3A4712 6.100/ 13.448
ATV340D22N4E, ATV340D22N4						
ATV340D30N4E	150/ 492.12	300/ 984.24	100	12.4	On the side	VW3A4706 6.500/ 14.330
ATV340D37N4E						
ATV340D45N4E	150/ 492.12	300/ 984.24	160	25	On the side	VW3A4707 8.500/ 18.739
ATV340D55N4E						
ATV340D75N4E	150/ 492.12	300/ 984.24	200	32.5	On the side	VW3A4708 9.500/ 20.944

(1) The filter selection tables give the maximum lengths for shielded cables connecting motors to drives. These maximum lengths are given as examples only, as they vary depending on the stray capacitance of the motors and the cables used. If motors are connected in parallel, it is the total length of all cables that should be taken into account.

(2) These values are given for a nominal switching frequency of 4 kHz.

(3) In: nominal filter current.

(4) Via heat dissipation, at the nominal filter current (In).

(5) Standard IEC 61800-3: EMC immunity and conducted and radiated EMC emissions:

- Category C2: public power supply (residential) and industrial power supply
- Category C3: industrial power supply

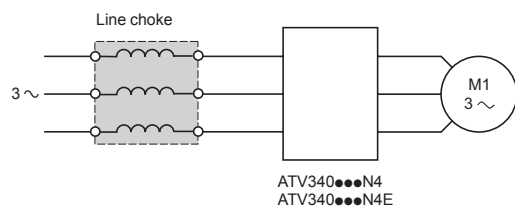

Presentation

Line chokes, also known as line reactors, provide improved immunity against overvoltages on the supply mains and can reduce harmonic distortion of the current produced by the drive.

The recommended chokes limit the input current. They have been developed in line with standard IEC 61800-5-1 (VDE 0160 level 1 high-energy overvoltages on the supply mains).

The inductance values are defined for a voltage drop between 3% and 5% of the nominal mains voltage. Values higher than this will cause loss of torque.

The use of line chokes is recommended in particular under the following circumstances:

- Supply mains with significant disturbance from other equipment (interference, overvoltages)
- Supply mains with voltage imbalance between phases > 1.8% of nominal voltage
- Drive supplied by a supply mains with very low impedance (in the vicinity of a power transformer 10 times more powerful than the drive rating)
- Installation of a large number of frequency inverters on the same supply mains
- Reduction of overloads on the $\cos \varphi$ correction capacitors, if the installation includes a power factor correction unit

Line chokes are mandatory for variable speed drives **ATV340U07...D22N4**, operating in normal duty mode, and have to be ordered separately (see page 37). External line chokes are not required for variable speed drives **ATV340D30...D75N4E**, in which integrated DC chokes serve for the same purpose.



VW3A4553
VW3A4554
VW3A4555



VW3A4556

References

Drive		Choke					Inductance	Reference	Weight
Reference (3)	Operation mode	Motor power	Input current without choke		Input current with choke				
			U min. (1)	U max. (1)	U min. (1)	U max. (1)			
		kW	A	A	A	A	mH	kg/lb	
Three-phase supply voltage: 380...480 V 50/60 Hz									
ATV340U07N4 ATV340U07N4E	Heavy duty	0.75	3.5	2.6	1.9	1.6	10	VW3A4551	1.500/ 3.307
	Normal duty (2)	1.1	–	–	2.6	2.1	10	VW3A4551	1.500/ 3.307
ATV340U15N4 ATV340U15N4E	Heavy duty	1.5	6.0	4.9	3.5	2.8	10	VW3A4551	1.500/ 3.307
	Normal duty (2)	2.2	–	–	5.1	4.1	4	VW3A4552	3.000/ 6.613
ATV340U22N4 ATV340U22N4E	Heavy duty	2.2	8.4	6.6	5.1	4.1	4	VW3A4552	3.000/ 6.613
	Normal duty (2)	3	–	–	6.6	5.3	4	VW3A4552	3.000/ 6.613
ATV340U30N4 ATV340U30N4E	Heavy duty	3	10.7	8.5	6.6	5.3	4	VW3A4552	3.000/ 6.613
	Normal duty (2)	4	–	–	8.6	6.8	4	VW3A4552	3.000/ 6.613
ATV340U40N4 ATV340U40N4E	Heavy duty	4	13.4	10.6	8.5	6.8	4	VW3A4552	3.000/ 6.613
	Normal duty (2)	5.5	–	–	11.4	9.0	2	VW3A4553	3.500/ 7.716
ATV340U55N4 ATV340U55N4E	Heavy duty	5.5	20.0	16.0	11.6	9.4	2	VW3A4553	3.500/ 7.716
	Normal duty (2)	7.5	–	–	15.3	12.2	2	VW3A4553	3.500/ 7.716
ATV340U75N4 ATV340U75N4E	Heavy duty	7.5	25.6	20.4	14.6	12.1	2	VW3A4553	3.500/ 7.716
	Normal duty (2)	11	–	–	22.0	17.7	1	VW3A4554	6.000/ 13.228
ATV340D11N4 ATV340D11N4E	Heavy duty	11	34.7	27.7	21.9	17.7	1	VW3A4554	6.000/ 13.228
	Normal duty (2)	15	–	–	28.8	23.0	1	VW3A4554	6.000/ 13.228
ATV340D15N4 ATV340D15N4E	Heavy duty	15	44.9	35.7	28.7	23.0	1	VW3A4554	6.000/ 13.228
	Normal duty (2)	18.5	–	–	37.4	30.2	0.5	VW3A4555	11.000/ 24.251
ATV340D18N4 ATV340D18N4E	Heavy duty	18.5	54.7	43.4	37.2	30.1	0.5	VW3A4555	11.000/ 24.251
	Normal duty (2)	22	–	–	43.4	35.0	0.5	VW3A4555	11.000/ 24.251
ATV340D22N4 ATV340D22N4E	Heavy duty	22	63.5	50.5	43.3	34.9	0.5	VW3A4555	11.000/ 24.251
	Normal duty (2)	30	–	–	60.1	48.6	0.3	VW3A4556	16.000/ 35.270

(1) Nominal supply voltage, $U_{min} = 380\text{ V} \sim$, $U_{max} = 480\text{ V} \sim$.

(2) A line choke is essential for the drive to operate in normal duty mode, so line current without choke is not applicable.

(3) For drives above 30 kW, ATV340D30N4E...D75N4E, a DC choke is integrated, so an extra line choke is not required.

Applications

Circuit breaker/contactor/drive combinations help to ensure continuity of service in the installation.

The type of circuit breaker/contactor coordination selected can reduce maintenance costs in the event of a short-circuit on the drive input by minimizing the time required to make the necessary repairs and the cost of replacement equipment. The suggested combinations provide coordination according to the drive rating.

The drive controls the motor, provides a monitoring function against short-circuits between the drive and the motor, and helps protect the motor cable against overloads. Overload monitoring is provided by the drive's motor thermal monitoring function if this has been enabled. Otherwise, an external monitoring device such as a probe or thermal overload relay should be provided.

The circuit breaker helps protect the drive's power cables against short-circuits.

IEC standard motor starters

Motor	Drive	Circuit breaker		Line contactor		
Power (1)	Reference	Reference (2)	Rating	I _{rm}		
kW	HP		A	A		
Three-phase supply voltage: 380...415 V 50/60 Hz						
0.75	1	ATV340U07N4●	GV2L10	6.3	78	LC1D09●●
1.5	2	ATV340U15N4●	GV2L14	10	138	LC1D09●●
2.2	3	ATV340U22N4●	GV2L16	14	170	LC1D12●●
3	4	ATV340U30N4●	GV2L22	25	327	LC1D18●●
4	5	ATV340U40N4●	GV2L22	25	327	LC1D25●●
5.5	7.5	ATV340U55N4●	GV2L32	32	448	LC1D32●●
7.5	10	ATV340U75N4●	GV3L40	40	560	LC1D38A●●
11	15	ATV340D11N4●	GV3L50	50	700	LC1D50A●●
15	20	ATV340D15N4●	GV3L65	65	910	LC1D65A●●
18.5	25	ATV340D18N4●	NS80H-MA (28100)	80	1040	LC1D80●●
22	30	ATV340D22N4●	NSX100N-MA100 (LV429750)	100	1300	LC1D95●●
30	40	ATV340D30N4E	NS80H-MA (28100)	80	1040	LC1D80●●
37	50	ATV340D37N4E	NSX100N-MA100 (LV429750)	100	1300	LC1D95●●
45	60	ATV340D45N4E	NSX100N-MA100 (LV429750)	100	1400	LC1D115●●
55	75	ATV340D55N4E	NSX160N-MA150 (LV430832)	150	1800	LC1D150●●
75	100	ATV340D75N4E	NSX250N-MA220 (LV431752)	220	2420	LC1F225●●

(1) Standard power ratings for 230 V 50/60 Hz 4-pole motors.
The values expressed in HP conform to the NEC (National Electrical Code).
(2) For references to be completed, replace the dot with the letter corresponding to the breaking performance of the circuit breaker (F, N, H, S or L).
Breaking capacity of circuit breakers according to standard IEC 60947-2:

Circuit breaker	I _{cu} (kA) for 380...415 V					
	F	N	H	S	L	
GV2L10...L14	100	—	—	—	—	
GV2L16...L32	50	—	—	—	—	
GV3L40...L65	50	—	—	—	—	
NS80H-MA	70	—	—	—	—	
NSX100●MA100	—	36	50	70	100	150
NSX160●MA150	—	36	50	70	100	150
NSX250●MA220	—	36	50	70	100	150

(3) Composition of contactors:
LC1D09...D150: 3 poles + 1 NO auxiliary contact + 1 NC auxiliary contact
LC1F225: 3 poles
To add auxiliary contacts or other accessories, please refer to the "Motor-starter solutions - Control and protection components" catalogue.
(4) Replace ●● with the control circuit voltage code indicated in the table below:

Circuit breaker	Volts ~	24	48	110	220	230	240
		LC1D09...D150	50 Hz	B5	E5	F5	M5
	60 Hz	B6	E6	F6	M6	—	U6
	50/60 Hz	B7	E7	F7	M7	P7	U7
LC1F225	50 Hz (LX1 coil)	B5	E5	F5	M5	P5	U5
	60 Hz (LX1 coil)	—	E6	F6	M6	—	U6
	40...400 Hz (LX9 coil)	—	E7	F7	M7	P7	U7

For other voltages available between 24 V ~ and 660 V ~, or a DC control circuit, please contact our Customer Care Center.



GV3L65

+



LC1D65A●●

+



ATV340D15N4



NSX100FMA100

+



LC1D95

+



ATV340D45N4E

IEC standard motor starters						
Motor	Drive	Circuit breaker			Line contactor	
Power (1)	Reference	Reference (2)	Rating	I _{rm}	Reference (3) (4)	
kW	HP		A	A		
Three-phase supply voltage: 440 V 50/60 Hz						
0.75	1	ATV340U07N4●	GV2L10	6.3	78	LC1D09●●
1.5	2	ATV340U15N4●	GV2L14	10	138	LC1D09●●
2.2	3	ATV340U22N4●	GV2L16	14	170	LC1D12●●
3	4	ATV340U30N4●	GV2L16	14	327	LC1D18●●
4	5	ATV340U40N4●	GV2L22	25	327	LC1D18●●
5.5	7.5	ATV340U55N4●	GV2L32	32	448	LC1D25●●
7.5	10	ATV340U75N4●	GV3L40	40	560	LC1D38●●
11	15	ATV340D11N4●	GV3L50	50	700	LC1D50A●●
15	20	ATV340D15N4●	GV3L65	65	910	LC1D65A●●
18.5	25	ATV340D18N4●	NS80H-MA (28100)	80	1040	LC1D80●●
22	30	ATV340D22N4●	NSX100N-MA100 (LV429750)	100	1300	LC1D95●●
30	40	ATV340D30N4E	NS80H-MA (28100)	80	1040	LC1D80●●
37	50	ATV340D37N4E	NSX100N-MA100 (LV429750)	100	1300	LC1D95●●
45	60	ATV340D45N4E	NSX100N-MA100 (LV429750)	100	1400	LC1D115●●
55	75	ATV340D55N4E	NSX160N-MA150 (LV430832)	150	1800	LC1D150●●
75	100	ATV340D75N4E	NSX250N-MA220 (LV431752)	220	2420	LC1F225●●

(1) Standard power ratings for 400 V 50/60 Hz 4-pole motors.

The values expressed in HP conform to the NEC (National Electrical Code).

(2) For references to be completed, replace the dot with the letter corresponding to the breaking performance of the circuit breaker (F, N, H, S or L). Breaking capacity of circuit breakers according to standard IEC 60947-2:

Circuit breaker	Icu (kA) for 440 V	Icu (kA) for 440 V				
		F	N	H	S	L
GV2L07...L10	100	–	–	–	–	–
GV2L14...L22	20	–	–	–	–	–
GV2L32...L65	50	–	–	–	–	–
NS80H-MA	65	–	–	–	–	–
NSX100●MA100	–	35	50	65	90	130
NSX160●MA150	–	35	50	65	90	130
NSX250●MA220	–	35	50	65	90	130

(3) Composition of contactors:

LC1D09...D150: 3 poles + 1 NO auxiliary contact + 1 NC auxiliary contact

LC1F225: 3 poles

To add auxiliary contacts or other accessories, please refer to the "Motor-starter solutions - Control and protection components" catalogue.

(4) Replace ●● with the control circuit voltage code indicated in the table below:

	Volts ~	24	48	110	220	230	240
		LC1D09...D150	50 Hz	B5	E5	F5	M5
	60 Hz	B6	E6	F6	M6	–	U6
	50/60 Hz	B7	E7	F7	M7	P7	U7
LC1F225	50 Hz (LX1 coil)	B5	E5	F5	M5	P5	U5
	60 Hz (LX1 coil)	–	E6	F6	M6	–	U6
	40...400 Hz (LX9 coil)	–	E7	F7	M7	P7	U7

For other voltages available between 24 V ~ and 660 V ~, or a DC control circuit, please contact our Customer Care Center.

Variable speed drives

Altivar Machine ATV340 Drives

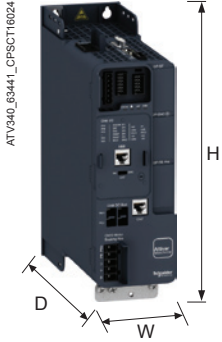

Modular drives
Three-phase supply voltage: 380...480 V 50/60 Hz

Overall dimensions

Drives	W x H x D (1)	
	mm	in.
ATV340U07N4	85 x 270 x 232.5	3.35 x 10.63 x 9.15
With EMC plate	85 x 398 x 232.5	3.35 x 15.67 x 9.15
ATV340U15N4	85 x 270 x 232.5	3.35 x 10.63 x 9.15
With EMC plate	85 x 398 x 232.5	3.35 x 15.67 x 9.15
ATV340U22N4	85 x 270 x 232.5	3.35 x 10.63 x 9.15
With EMC plate	85 x 398 x 232.5	3.35 x 15.67 x 9.15
ATV340U30N4	85 x 270 x 232.5	3.35 x 10.63 x 9.15
With EMC plate	85 x 398 x 232.5	3.35 x 15.67 x 9.15
ATV340U40N4	85 x 270 x 232.5	3.35 x 10.63 x 9.15
With EMC plate	85 x 398 x 232.5	3.35 x 15.67 x 9.15
ATV340U55N4	110 x 270 x 234	4.33 x 10.63 x 9.21
With EMC plate	110 x 398 x 234	4.33 x 15.67 x 9.21
ATV340U75N4	110 x 270 x 234	4.33 x 10.63 x 9.21
With EMC plate	110 x 398 x 234	4.33 x 15.67 x 9.21
ATV340D11N4	180 x 385 x 249	7.09 x 15.16 x 9.80
With EMC plate	180 x 541 x 249	7.09 x 21.30 x 9.80
ATV340D15N4	180 x 385 x 249	7.09 x 15.16 x 9.80
With EMC plate	180 x 541 x 249	7.09 x 21.30 x 9.80
ATV340D18N4	180 x 385 x 249	7.09 x 15.16 x 9.80
With EMC plate	180 x 541 x 249	7.09 x 21.30 x 9.80
ATV340D22N4	180 x 385 x 249	7.09 x 15.16 x 9.80
With EMC plate	180 x 541 x 249	7.09 x 21.30 x 9.80

(1) The total depth excludes the option modules, + 20 mm/0.79 in. in depth if combined with the option module. For a cabinet installation that uses front wiring for an option module, + 60 mm/2.36 in. in depth is required. Front wiring used for ATV340U07...D22N4 drives.

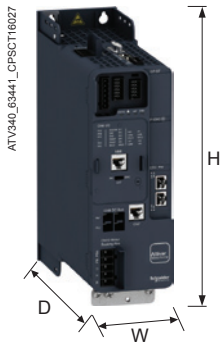

Ethernet embedded drives
Three-phase supply voltage: 380...480 V 50/60 Hz

Overall dimensions

Drives	W x H x D	
	mm	in.
ATV340U07N4E	85 x 270 x 232.5	3.35 x 10.63 x 9.15
With EMC plate	85 x 398 x 232.5	3.35 x 15.67 x 9.15
ATV340U15N4E	85 x 270 x 232.5	3.35 x 10.63 x 9.15
With EMC plate	85 x 398 x 232.5	3.35 x 15.67 x 9.15
ATV340U22N4E	85 x 270 x 232.5	3.35 x 10.63 x 9.15
With EMC plate	85 x 398 x 232.5	3.35 x 15.67 x 9.15
ATV340U30N4E	85 x 270 x 232.5	3.35 x 10.63 x 9.15
With EMC plate	85 x 398 x 232.5	3.35 x 15.67 x 9.15
ATV340U40N4E	85 x 270 x 232.5	3.35 x 10.63 x 9.15
With EMC plate	85 x 398 x 232.5	3.35 x 15.67 x 9.15
ATV340U55N4E	110 x 270 x 234	4.33 x 10.63 x 9.21
With EMC plate	110 x 398 x 234	4.33 x 15.67 x 9.21
ATV340U75N4E	110 x 270 x 234	4.33 x 10.63 x 9.21
With EMC plate	110 x 398 x 234	4.33 x 15.67 x 9.21
ATV340D11N4E	180 x 385 x 249	7.09 x 15.16 x 9.80
With EMC plate	180 x 541 x 249	7.09 x 21.30 x 9.80
ATV340D15N4E	180 x 385 x 249	7.09 x 15.16 x 9.80
With EMC plate	180 x 541 x 249	7.09 x 21.30 x 9.80
ATV340D18N4E	180 x 385 x 249	7.09 x 15.16 x 9.80
With EMC plate	180 x 541 x 249	7.09 x 21.30 x 9.80
ATV340D22N4E	180 x 385 x 249	7.09 x 15.16 x 9.80
With EMC plate	180 x 541 x 249	7.09 x 21.30 x 9.80
ATV340D30N4E	213 x 660 x 262	8.39 x 25.98 x 10.31
ATV340D37N4E	213 x 660 x 262	8.39 x 25.98 x 10.31
ATV340D45N4E	271 x 908 x 309	10.67 x 35.75 x 12.17
ATV340D55N4E	271 x 908 x 309	10.67 x 35.75 x 12.17
ATV340D75N4E	271 x 908 x 309	10.67 x 35.75 x 12.17

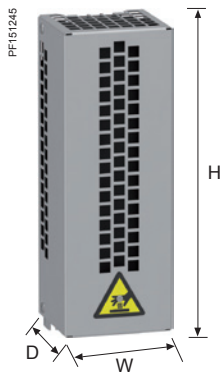

Braking resistors

Overall dimensions

Braking resistors	W x H x D	
	mm	in.
VW3A7730	105 x 295 x 100	4.13 x 11.61 x 3.94
VW3A7731	105 x 345 x 100	4.13 x 13.58 x 3.94
VW3A7732	175 x 345 x 100	6.89 x 13.58 x 3.94
VW3A7733	190 x 570 x 180	7.48 x 22.44 x 7.09
VW3A7734	250 x 490 x 180	9.84 x 19.29 x 7.09
VW3A7735	250 x 490 x 180	9.84 x 19.29 x 7.09
VW3A7736	485 x 410 x 485	19.09 x 16.14 x 19.09
VW3A7740	105 x 465 x 100	4.13 x 18.31 x 3.94
VW3A7741	175 x 465 x 100	6.89 x 18.31 x 3.94
VW3A7742	190 x 570 x 180	7.48 x 22.44 x 7.09
VW3A7743	290 x 570 x 180	11.42 x 22.44 x 7.09
VW3A7744	450 x 490 x 180	17.72 x 19.29 x 7.09
VW3A7745	485 x 610 x 485	19.09 x 24.02 x 19.09
VW3A7746	485 x 610 x 485	19.09 x 24.02 x 19.09
VW3A7750	290 x 570 x 180	11.42 x 22.44 x 7.09
VW3A7751	390 x 570 x 180	15.35 x 22.44 x 7.09
VW3A7752	485 x 610 x 485	19.09 x 24.02 x 19.09
VW3A7753	485 x 1020 x 605	19.09 x 40.16 x 23.82
VW3A7754	485 x 820 x 1035	19.09 x 32.28 x 40.75
VW3A7755	485 x 1020 x 1035	19.09 x 40.16 x 40.75
VW3A7756	485 x 1020 x 1285	19.09 x 40.16 x 50.59

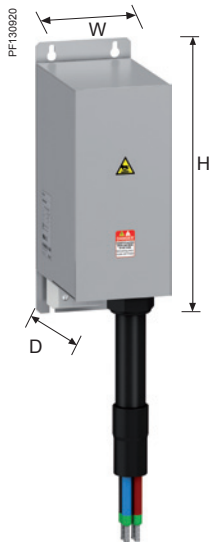

Additional EMC filters

Overall dimensions

EMC filters	W x H x D	
	mm	in.
VW3A4706	120 x 340 x 180	4.72 x 13.39 x 7.09
VW3A4707	130 x 395 x 240	5.12 x 15.55 x 9.45
VW3A4708	200 x 445 x 320	7.87 x 17.52 x 12.60
VW3A4711	90 x 285 x 170	3.54 x 11.22 x 6.69
VW3A4712	100 x 330 x 180	3.94 x 12.99 x 7.09
VW3A4422	107 x 195 x 42	4.21 x 7.68 x 1.65
VW3A4423	140 x 235 x 50	5.51 x 9.25 x 1.97

Line chokes

Overall dimensions

Motor chokes	W x H x D	
	mm	in.
VW3A4553	130 x 155 x 90	5.12 x 6.10 x 3.54
VW3A4554	155 x 170 x 135	6.10 x 6.69 x 5.31
VW3A4555	180 x 210 x 165	7.09 x 8.27 x 6.50
VW3A4556	270 x 210 x 180	10.63 x 8.27 x 7.09

Variable speed drives

Altivar Machine

A whole world of Services for your Drives by Schneider Electric



Presentation

Schneider Electric offers an extensive range of support services to help ensure the reliability of your installation in the long term, control your maintenance costs, and keep your process running at peak performance for maximum efficiency. Altivar Machine has been designed in harmony with a whole range of services offered by Schneider Electric.

A worldwide network, 24/7: <ul style="list-style-type: none"> 400 highly qualified and certified experts Field service engineers, online experts 		A digital world of Services: <ul style="list-style-type: none"> "Schneider Electric Customer Care" app Remote technical support 	
People			Digitized support material
Spare parts			Service provisions
A dedicated supply chain: <ul style="list-style-type: none"> Access to the spare parts you need Designed and manufactured by Schneider Electric 		An optimal life cycle model: <ul style="list-style-type: none"> Spare parts management, Exchange and Repairs Extended warranties, Maintenance plans 	

Schneider Electric drive maintenance expert certification

A worldwide network, 24/7:

- 400 highly qualified and certified experts
- Our Field Service Engineers follow a proven Drives certification program designed to support you with maximum expertise and efficiency.
- For fast, in-depth diagnostics and repairs, they are equipped with professional tools and software.

	Repair Centers	Low Voltage (LV) Drives field service engineers	Medium Voltage (MV) Drives field service engineers
Module A	LV drive safety training		MV drive safety training
Module B	Technical training for LV drives		Technical training for MV drives
Module C	Repair center audit	Skills assessment	On-site start-up
Module D	Certification procedure		
Module E	Registration in Schneider Electric's international directory of Drives skills		
Module F	Re-certification every 2 years		

Variable speed drives

Altivar Machine

A whole world of Services for your Drives by Schneider Electric

Drives support and services offer by Schneider Electric

Schneider Electric has developed a generic Services offer to assist you throughout the life cycle of your product. From the Design to Renew phase, whether for standard or critical operations, you'll find the solution you need in our set of standardized offers.

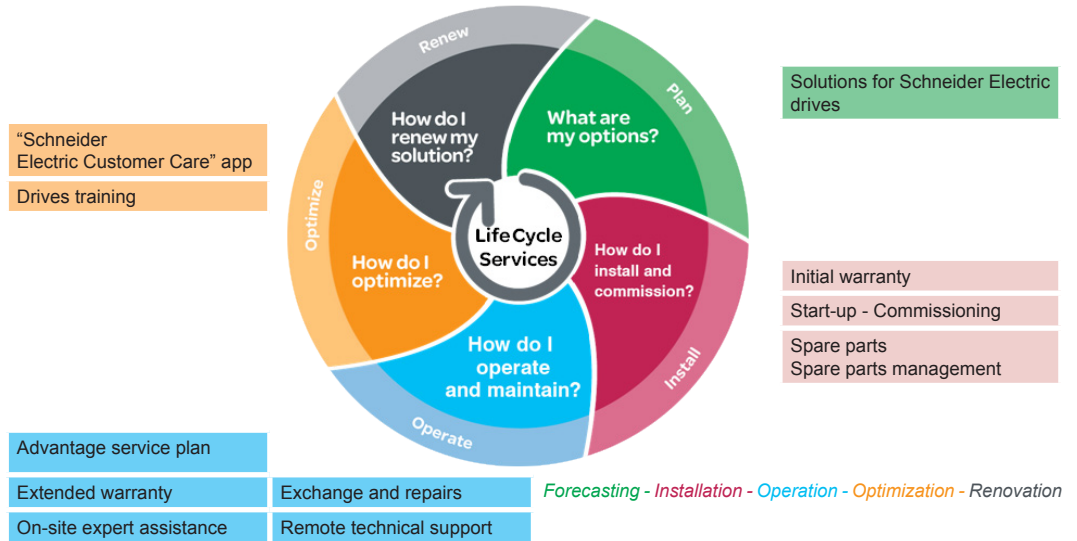

The offer	Contact, How to order	Description
Solutions for Schneider Electric drives	Contact your local Schneider Electric service center	Our Schneider Electric experts can help you design your installation, offering whatever type of assistance you need from technical support to "turnkey" solutions.
Start-up - Commissioning	Contact your local Schneider Electric service center	Our team of experts are specialists in installation commissioning and start-up whatever the conditions and for any application. This will extend your warranty period by an extra 6 months.
Spare parts - Spare parts management	Contact your local Schneider Electric service center	Our spare parts are available for the whole life time of your equipment. They are designed and manufactured to the same high quality standards as our products. They are available via a dedicated supply chain for emergency shipments. Our team can help you identify critical parts and define the right level of the required stock. Whether stored in your premises (on-site) or in a central store (off-site), it's reassuring to know that critical spare parts are available 24/7.
Exchange and repairs	Contact your local Schneider Electric service center	Schneider Electric offers high-quality repair services via a global network of certified Repair Centers and certified Field Service Engineers to cover any need: repairs in Schneider Electric repair centers or exchanges with refurbished products, or on-site repairs (Schneider Electric intervention on your premises).
Remote technical support	Contact your local Schneider Electric service center	Direct priority access to our experts to help you solve any technical difficulties. Our experts have extensive field experience and have fully mastered the technologies implemented. A simple phone conversation or online chat support are usually sufficient to help you find the best solution and can reduce your costs by avoiding on-site intervention.
On-site technical support	Contact your local Schneider Electric service center	Our field service engineers can support your maintenance staff in their everyday operations, or attend when requested in the event of an emergency.
Extended warranty	Contact your local Schneider Electric service center	Spare parts and repairs performed by Schneider Electric experts on duty.
Advantage service plan	Contact your local Schneider Electric service center	The Advantage Service plan combines the Preventive Maintenance program (annual visit for inspection, checks and replacement of worn parts) with the extended warranty (covering spare parts and repairs), plus remote technical support.
Drives training	Contact your local Schneider Electric service center	A comprehensive set of training courses to help you master your Altivar Process drive at any stage in the life cycle of your installation.
"Schneider Electric Customer Care" app	Download from the Apple Store® or Google Play Store™	Free download from the Apple Store® or Google Play Store™. Immediate access to Schneider Electric Customer Care Centers, product documentation, FAQs, Cloud services, etc. and plenty of other services yet to come.

4					
490NTC00005	28	TSXCANCB50	29	VW3A7741	33
490NTC00005U	28	TSXCANCB100	29	VW3A7742	33
490NTC00015	28	TSXCANCB300	29	VW3A7743	33
490NTC00015U	28	TSXCANCBDD1	30	VW3A7744	33
490NTW00002	28	TSXCANCBDD03	30	VW3A7745	33
490NTW00002U	28	TSXCANCBDD3	30	VW3A7746	33
490NTW00005	28	TSXCANCBDD5	30	VW3A7750	33
490NTW00005U	28	TSXCANCD50	29	VW3A7751	33
490NTW00012	28	TSXCANCD100	29	VW3A7752	33
490NTW00012U	28	TSXCANCD300	29	VW3A7753	33
		TSXCANKCDF90T	29	VW3A7754	33
		TSXCANKCDF180T	29	VW3A7755	33
		TSXCANTDM4	30	VW3A7756	33
A				VW3A8115	19
ATV340D11N4	12			VW3A8306R	27
ATV340D11N4E	13	V		VW3A8306R03	27
ATV340D15N4	12	VW3A1104R10	17	VW3A8306R10	27
ATV340D15N4E	13		19	VW3A8306R30	27
ATV340D18N4	12	VW3A1104R30	17	VW3A8306RC	27
ATV340D18N4E	13		19	VW3A8306TF03	27
ATV340D22N4	12	VW3A1104R50	17	VW3A8306TF10	27
ATV340D22N4E	13		19	VW3A34001	15
ATV340D30N4E	13	VW3A1104R100	17	VW3A34002	15
ATV340D37N4E	13		19	VW3A34003	15
ATV340D45N4E	13	VW3A1111	18	VW3CANCARR1	29
ATV340D55N4E	13	VW3A1112	19	VW3CANCARR03	29
ATV340D75N4E	13	VW3A1113	16	VW3CANKCDF180T	29
ATV340U07N4	12	VW3A1114	17	VW3CANTAP2	30
ATV340U07N4E	13	VW3A1115	19	VW3M2207	14
ATV340U15N4	12	VW3A3203	25	VW3M2606	14
ATV340U15N4E	13	VW3A3204	25	VW3M3802	29
ATV340U22N4	12	VW3A3420	24	VW3M4701	24
ATV340U22N4E	13	VW3A3422	24	VW3M7101R01	14
ATV340U30N4	12	VW3A3423	24	VW3M7102R150	14
ATV340U30N4E	13	VW3A3601	31	VW3M8221R1000	24
ATV340U30N4E	13	VW3A3607	31	VW3M8222R250	24
ATV340U40N4	12	VW3A3608	29	VW3M8222R500	24
ATV340U40N4E	13	VW3A3609	31	VW3M8223R30	14
ATV340U55N4	12	VW3A3618	29	VW3M8502R03	14
ATV340U55N4E	13	VW3A3627	31	VW3M8502R15	14
ATV340U75N4	12	VW3A3628	30	VX5VMS1001	15
ATV340U75N4E	13	VW3A4422	35	VX5VMS2001	15
		VW3A4423	35	VX5VMS3001	15
		VW3A4430	14	VX5VPS4001	15
		VW3A4431	14	VX5VPS5001	15
		VW3A4432	14		
		VW3A4551	37	Z	
		VW3A4552	37	ZB5AZ905	17
		VW3A4553	37		19
		VW3A4554	37		
		VW3A4555	37		
		VW3A4556	37		
		VW3A4706	35		
		VW3A4707	35		
		VW3A4708	35		
		VW3A4711	35		
		VW3A4712	35		
		VW3A7730	32		
			33		
		VW3A7731	32		
		VW3A7732	32		
		VW3A7733	32		
		VW3A7734	32		
		VW3A7735	32		
		VW3A7736	32		
		VW3A7740	33		

Allivar drives



Schneider Electric Industries SAS

Head Office
35, rue Joseph Monier
F-92500 Rueil-Malmaison
France

www.schneider-electric.com/drives

The information provided in this documentation contains general descriptions and/or technical characteristics of the performance of the products contained herein. This documentation is not intended as a substitute for and is not to be used for determining suitability or reliability of these products for specific user applications. It is the duty of any such user or integrator to perform the appropriate and complete risk analysis, evaluation and testing of the products with respect to the relevant specific application or use thereof. Neither Schneider Electric nor any of its affiliates or subsidiaries shall be responsible or liable for misuse of the information contained herein.

Design: Schneider Electric
Photos: Schneider Electric